

SmartPTT Installation and Configuration Guide

Revision History

Revision	Description	Date
1.1	<p>Second release of the document. The document is compliant with SmartPTT Enterprise 9.7.1.</p> <ul style="list-style-type: none">• Multiple enhancements• Added:<ul style="list-style-type: none">• Configuring Antivirus Software• SmartPTT Mobile and its subsection• Modified:<ul style="list-style-type: none">• Location• Configuring SmartPTT Identification• Removed:<ul style="list-style-type: none">• Capacity Max Settings• Data Gateway Settings in Capacity Max	May 2020
1.0	<p>Initial release of the document. The document is compliant with SmartPTT Enterprise 9.7.</p> <p>The document substitutes the following outdated manuals:</p> <ul style="list-style-type: none">• SmartPTT Enterprise Installation and Configuration Guide• SmartPTT Enterprise Radioserver Configurator User Guide• SmartPTT Enterprise System Requirements	February 2020

Contents

Revision History	2
About This Document	12
1. Preliminary Configuration	13
1.1 Addressing	13
1.2 Accounts Settings	13
1.3 Disk Space Estimation	14
1.4 Positioning Services	15
1.4.1 Outdoor Positioning Services	15
1.4.2 Indoor Positioning Services	15
1.4.3 Online Map Keys	16
1.4.3.1 Google Map Keys	16
1.5 NTP Services	17
1.6 Power Saving Mode	17
1.7 Date and Time Format	17
1.8 Generating HID with a Standalone Utility	18
2. System Requirements	19
2.1 Minimum System Requirements for SmartPTT Dispatcher	19
2.2 Minimum System Requirements for SmartPTT Radioserver	20
2.3 Networking Requirements	22
2.3.1 Network Quality	22
2.3.2 Bandwidth Requirements	22
2.4 Support and Compatibility	25
2.4.1 MOTOTRBO Infrastructure	25
2.4.2 Elcomplus Products	26
2.4.3 Third Party Products	26
2.5 Audio File Requirements	28
3. Software Installation	29
3.1 Installing on New Computers	29
3.2 Modifying Installed Software	31
3.3 Dispatch Software Upgrade	32
3.4 Configuring Antivirus Software	33
4. Base Configuration	34

- 4.1 DBMS Configuration 34
 - 4.1.1 Configuring DBMS Autostart 34
 - 4.1.2 Configuring Remote DBMS Access 36
 - 4.1.3 Adding SQL Server Users 39
 - 4.1.4 Limiting DBMS Memory Use 41
- 4.2 Licensing 42
 - 4.2.1 Generating Hardware ID 43
 - 4.2.2 Installing License 44
 - 4.2.3 Viewing License Items 45
- 4.3 Configuring Radioserver 47
 - 4.3.1 Managing Radio Groups 48
- 4.4 Radios and Radio Users 49
 - 4.4.1 Registration of Radios 49
 - 4.4.1.1 MOTOTRBO Registration 50
 - 4.4.1.2 Configuring ARS 51
 - 4.4.2 Registration with Option Boards 52
 - 4.4.2.1 Programming GOB for Heartbeats 52
 - 4.4.2.2 Configuring SmartPTT to Support Heartbeats 53
 - 4.4.3 Radio Users 54
 - 4.4.3.1 Configuring User Database Connection 54
 - 4.4.3.2 Managing Radio Users 56
 - 4.4.3.3 Configuring User Database Autobackup 58
- 4.5 Location 60
 - 4.5.1 Location in Radio Systems 61
 - 4.5.1.1 Configuring GPS 63
 - 4.5.2 Location with Option Boards 64
 - 4.5.2.1 Configuring Location Storage in GOB 65
 - 4.5.2.2 Configuring GOB Reverting 67
 - 4.5.2.3 Configuring GOB Reports Reception 69
 - 4.5.3 Beacon-Based (Indoor) Location 70
 - 4.5.3.1 iBeacons Technology 71
 - 4.5.3.2 BluFi and Kilchherr 72
 - 4.5.3.3 Configuring Beacons in SmartPTT 72

4.5.4 Complex Location Reports	74
4.6 Activating TMS and Telemetry	75
4.7 Logging	75
4.7.1 Event Log Database	77
4.7.1.1 Configuring Event Log Database Connection	77
4.7.1.2 Configuring Event Log Database Retention Policy	79
4.7.1.3 Configuring Event Log Database Autobackup	80
4.7.2 Voice Recording	82
4.7.2.1 Configuring Centralized Voice Logging	84
4.7.2.2 Configuring NexLog Connection	86
4.7.3 Monitoring Database	87
4.7.3.1 Configuring Monitoring Database Connection	88
4.7.3.2 Configuring Monitoring Database Retention Policy	89
4.7.3.3 Configuring Monitoring Database Autobackup	91
4.7.4 Event Viewer	93
4.8 Configuring Black/White Lists	93
5. MOTOTRBO Radio Systems	95
5.1 Single-Site MOTOTRBO Systems	95
5.1.1 ERDM Systems	95
5.1.2 SmartPTT Features in ERDM	96
5.1.3 ERDM Systems Configuration	97
5.1.3.1 Adding and Editing ERDM System Configuration	99
5.1.3.2 Configuring SmartPTT Identification in ERDM	101
5.1.3.3 Adding and Editing Groups in ERDM	102
5.2 IP Site Connect	104
5.2.1 IP Site Connect over NAI	104
5.2.2 Digital Backhaul	105
5.2.3 SmartPTT Features in IP Site Connect	106
5.2.4 IP Site Connect Configuration (direct)	107
5.2.4.1 Adding and Editing IP Site Connect	108
5.2.4.2 Configuring Slots	110
5.2.4.3 Adding and Editing Talkgroups	113
5.2.4.4 Configuring Encryption	114

- 5.2.5 IP Site Connect Configuration (NAI) 115
 - 5.2.5.1 Adding and Editing IP Site Connect over NAI 117
 - 5.2.5.2 Configuring SmartPTT Identification 118
 - 5.2.5.3 Adding and Editing Talkgroups in IPSC (NAI) 121
- 5.3 Capacity Plus 122
 - 5.3.1 Capacity Plus over Hybrid Interface 122
 - 5.3.2 Capacity Plus over NAI 123
 - 5.3.3 SmartPTT Features in Capacity Plus 124
 - 5.3.4 Capacity Plus Configuration (Hybrid) 125
 - 5.3.4.1 Configuring Capacity Plus Connection 126
 - 5.3.4.2 Configuring RX Interface 129
 - 5.3.4.3 Configuring Incoming Group Calls in Capacity Plus 130
 - 5.3.4.4 Configuring Voice Decryption 131
 - 5.3.4.5 Configuring Local TX Station Connection 133
 - 5.3.4.6 Configuring Local TX Station Groups 135
 - 5.3.4.7 Configuring Local TX Station Audio 137
 - 5.3.4.8 Remote TX Station Configuration 138
 - 5.3.4.8.1 Configuring Remote TX Station Connection 139
 - 5.3.4.8.2 Configuring Remote TX Station Groups 143
 - 5.3.4.8.3 Configuring Remote TX Station Audio 145
 - 5.3.4.9 Duplicating TX Station Groups 146
 - 5.3.5 Capacity Plus Configuration (NAI) 147
 - 5.3.5.1 Adding and Editing Capacity Plus (NAI) 148
 - 5.3.5.2 Configuring SmartPTT Identification in Capacity Plus (NAI) 150
 - 5.3.5.3 Adding and Editing Talkgroups in Capacity Plus (NAI) 152
- 5.4 Linked Capacity Plus 153
 - 5.4.1 SmartPTT Features in LCP 154
 - 5.4.2 Linked Capacity Plus Configuration 155
 - 5.4.2.1 Adding and Editing LCP Connection 156
 - 5.4.2.2 Configuring SmartPTT Identification 158
 - 5.4.2.3 Adding and Editing Groups in LCP 160
- 5.5 Capacity Max 161
 - 5.5.1 Capacity Max Feature Overview 162

- 5.5.2 Capacity Max Configuration Brief 163
- 5.5.3 Adding and Editing Capacity Max 163
- 5.5.4 Connecting to Presence Servers 165
- 5.5.5 Connecting to Data Gateways 167
- 5.5.6 Adding and Editing Groups in Capacity Max 169
- 5.6 Connect Plus 170
 - 5.6.1 SmartPTT Features in Connect Plus 170
 - 5.6.2 Connect Plus Configuration 171
 - 5.6.2.1 Adding and Editing Connect Plus 172
 - 5.6.2.2 Adding and Editing XRC Controllers 173
 - 5.6.2.3 Adding and Editing Talkgroups in Connect Plus 176
 - 5.6.2.3.1 Copying Talkgroups Between Controllers 177
 - 5.6.3 Connect Plus Glossary 178
- 5.7 Universal SmartPTT Configuration 178
 - 5.7.1 Configuring DDMS Connection 178
 - 5.7.2 Configuring MNIS Data Gateway 179
 - 5.7.3 Configuring SmartPTT MNIS Data Gateway Relay 181
- 5.8 MOTOTRBO Control Stations 182
 - 5.8.1 Control Station Features 183
 - 5.8.2 MOTOTRBO Stations Configuration 184
 - 5.8.3 MOTOTRBO Station Access over USB+Audio 185
 - 5.8.3.1 Adding and Editing MOTOTRBO Control Stations 186
 - 5.8.3.2 Adding and Editing MOTOTRBO Groups 189
 - 5.8.3.3 Adding and Editing MOTOTRBO Channels 190
 - 5.8.3.4 Configuring MOTOTRBO Audio Settings 192
 - 5.8.4 MOTOTRBO Station Access over RG-1000e 193
 - 5.8.4.1 Adding and Editing Remote MOTOTRBO 194
 - 5.8.4.2 Adding and Editing Remote MOTOTRBO Groups 200
 - 5.8.4.3 Adding and Editing Remote MOTOTRBO Channels 201
 - 5.8.4.4 Configuring Remote MOTOTRBO Audio Settings 203
- 5.9 Group Duplication 203
- 5.10 Security Key Duplication 204
- 6. Other VoIP Systems 205**

6.1 SIP Telephony	205
6.1.1 Telephony Features	206
6.1.1.1 Call Process	206
6.1.2 Telephony Connection Overview	207
6.1.2.1 Call Masks	208
6.1.2.2 Phone Call Codes	210
6.1.3 Configuring Phone Calls	211
6.1.4 Connecting to PBX	213
6.1.4.1 Limiting Access to PBX	215
6.1.5 Configuring Incoming Calls	217
6.1.6 Configuring Autoreply	218
6.1.7 Configuring Outgoing Calls	220
6.2 Analog Interfaces	222
6.2.1 Analog Interface Configuration	223
6.2.2 Configuring Station Connection over Analog Interface	224
6.2.3 Configuring Channels for Analog Interface	228
6.2.4 Configuring Audio Processing over Analog Interface	229
6.3 Analog Radio Systems	230
7. Data Exchange Systems	231
7.1 Email Services	231
7.1.1 Configuring Message Processing	232
7.1.2 Connecting to POP/IMAP Services	234
7.1.3 Connecting to SMTP Services	236
7.1.4 Email Message Requirements	238
7.1.5 TMS Requirements	239
7.2 Mobile Phone Networks	240
7.2.1 Configuring SMS and TMS Processing	240
7.2.2 Connecting to Phone Modems	241
7.2.2.1 Testing Modem Operation	243
7.2.3 SMS Messages for Radio Networks	244
7.2.4 TMS Messages for Phone Networks	245
7.3 SmartPTT File Transfer	246
7.3.1 Configuring File Receive	247

7.4 Avigilon	247
7.4.1 Configuring Avigilon Connection	248
7.5 ID-to-IP Conversion	249
8. SmartPTT Profiling	251
8.1 Client Connections	251
8.1.1 Desktop Clients	251
8.1.1.1 Configuring Desktop Clients Connection	252
8.1.2 Web Clients	254
8.1.2.1 Configuring Web Client Connection	255
8.1.3 SmartPTT Mobile	257
8.1.3.1 Configuring SmartPTT Mobile Connection	258
8.1.4 SmartPTT SCADA	259
8.1.5 Third-Party Apps	260
8.1.5.1 Configuring Third-Party Applications	261
8.1.6 Profiles	262
8.1.6.1 Available Networks	263
8.1.6.2 Available Actions	264
8.1.6.3 Managing Profiles	266
8.1.6.3.1 Configuring Available Networks	267
8.1.6.3.2 Configuring Available Actions	269
8.1.7 Managing Account Parameters	271
8.2 Voice Notifications	273
8.2.1 Managing Voice Notifications	273
8.3 Bridging	276
8.3.1 Multigroups	277
8.3.2 Managing Bridging	277
8.3.3 Managing Multigroups	278
8.3.4 Configuring Multigroups	279
8.4 Rules	281
8.4.1 Rule Conditions	282
8.4.1.1 Condition Attributes	282
8.4.1.2 Condition Operators	283
8.4.2 Adding or Modifying Rules for Radios	284

8.4.2.1 Configuring Actions	286
8.4.3 Adding or Modifying Rules for Dispatcher	286
8.4.4 Managing Rules	287
8.5 Network Monitoring	288
8.5.1 External SNMP Services	288
8.5.1.1 Configuring SNMP Server Connection	289
8.5.2 Configuring SNMP for Radioserver	290
8.5.3 Configuring Radioserver Monitoring in the Network	291
8.5.4 Adding and Configuring Repeaters	292
8.5.5 Adding and Configuring Devices	293
8.5.6 Adding and Configuring Locations	295
8.5.7 Configuring Local Stations Monitoring	297
8.5.8 Configuring Remote Gateway Monitoring	298
8.5.8.1 Configuring Remote Control Stations Monitoring	300
8.5.9 Configuring Alarm Notifications	301
8.5.10 Updating Topology	304
8.6 Exporting Settings	306
8.7 Firewall Configuraiton	307
8.7.1 Radioserver Host	307
8.7.2 Dispatch Console Host	317
8.7.3 Firewall Conventions	318
9. Alternation (Redundancy)	320
9.1 Configuring Redundant Radioserver	320
9.1.1 Configuring the Correspondence Table	322
9.1.1.1 Setting Values	322
9.1.1.2 Setting Parameters	323
10. Maintenance	325
10.1 Viewing System Events	325
10.1.1 Event Types	326
10.1.2 Alarm Text Messages on Devices	328
10.2 Importing Settings	329
10.3 Restoring Event Log Database	330
10.4 Restoring Monitoring Database	332

Contents

10.5 Restoring User Database	333
11. Troubleshooting	335
11.1 General Recommendations	335
11.2 SmartPTT Installation Problems	335
11.3 SmartPTT Startup Problems	336
11.4 Problems with Databases	336
Contact Information	338

About This Document

This document describes installation, configuration, and the following maintenance of the SmartPTT dispatch software. The document is intended for engineers who have an experience of the client—server software configuration for Windows operating systems.

Additional Information

The document does **not** contain information about dispatch console configuration and use. All the corresponding information is available in *SmartPTT Dispatcher Guide*.

The document does **not** contain information related to the Windows computer administration as well as the radio device configuration. The only exceptions is being made for parameters that are required for SmartPTT configuration. All the corresponding information can be obtained from the following sources:

Source	Description
Microsoft Docs	Microsoft documentation storage for end users, developers, and IP professionals.
MOTOTRBO™ Systems	Information on MOTOTRBO family of products by Motorola Solutions.

If you need assistance in radio devices configuration or computer administration, submit a request to [SmartPTT Technical Support Center](#).

1 Preliminary Configuration

Before the SmartPTT installation, various preliminary actions must be performed. The following information describes the required configuration without providing details and instructions for its implementation.

1.1 Addressing

SmartPTT operates in IP networks that use Internet Protocol version 4 (IPv4). SmartPTT does not support IPv6.

SmartPTT software can be installed on computers with multiple active IP addresses. At the same time it may require to select specific IP addresses to connect to various services or devices.

SmartPTT partly supports domain names. For example, the SmartPTT Radioserver address can be set as a domain name in the SmartPTT Dispatcher settings. However, in many other situations it is necessary to use exactly IP addresses.

Important

The use of domain names may require the support of the DNS server in the customer network or making changes to the Windows system files (for example, the **hosts** file).

Because some SmartPTT Radioserver settings require IP address selecting, IP addresses have to be fixed for each computer where the SmartPTT software is installed. For this, static IP addressing can be used or IP addresses should be assigned to MAC addresses over Dynamic Host Configuration Protocol (DHCP).

1.2 Accounts Settings

SmartPTT can use Windows authentication to a limited extent.

For SmartPTT Dispatcher configuring of automatic authorization for the current Windows account is available. For this, a user with administrator privileges must add the name of the Windows user to the SmartPTT Dispatcher operators list. Both local and domain accounts can be used for automatic login.

Important

With this configuration it may be necessary to log on to Windows operation system under a different account to change the operator account.

If Windows authorization is not used, for authentication in SmartPTT Dispatcher the user name and password set by the administrator of SmartPTT Dispatcher have to be specified.

Client applications accounts are managed in SmartPTT Radioserver Configurator. Those applications are SmartPTT Dispatcher, SmartPTT Web Client, SmartPTT Mobile, SmartPTT SCADA, and third-party applications.

Important

Automatic connection between the primary and redundant radioservers is available only for desktop clients and third-party applications.

Client authentication does not depend on the Windows authentication and authorization services. SmartPTT provides the ability to use the same credentials for the simultaneous authorization in different applications.

1.3 Disk Space Estimation

SmartPTT software uses disk space on the computer as follows:

- The installed SmartPTT Radioserver (primary or redundant) uses 350–400 MB.
- The installed SmartPTT Dispatcher application occupies 350–400 MB.
- A database management system (DBMS) manages several databases. The maximum database size is determined by the SQL server.
- SmartPTT stores downloaded maps and plans in the file system or database. For details, see “Map” in *SmartPTT Dispatcher Guide*.
- If necessary, each SmartPTT component can be configured to create and manage backup copies of databases.
- If necessary, each SmartPTT component can provide records of voice transmissions independent of each other and save them as audio files on local or network storage.

To estimate the required space and select the appropriate drive, it is necessary to consider all the aspects mentioned above.

If you require an assistance in free disk space calculations, contact the Elcomplus LLC representative in your region.

Voice Transmission Records

Records of voice transmissions are saved to a hard disk as unencrypted audio files in MP3, OGG or WAV format. They can be stored both on local and network file storage. To access the folder, only the file protocol must be used; other protocols are not supported. Either it is possible to access the folder without authorization.

The one minute voice transmission takes approximately 300 KB (B). To estimate the required space, consider the following:

- The average number of recorded voice transmissions during the working day or shift (N).
- The average duration of voice transmissions during the working day or shift (D).
- Storage duration of voice transmissions (P).
- The safety factor assuming the excess of real values over the average (R).

To estimate the required disk space, the specified parameters have to be multiplied with each other. If necessary, the result must be converted to the required units of measure.

$$C = B \cdot N \cdot D \cdot P \cdot R$$

EXAMPLE

In a system with 200 active radios every 5 minutes ($N = 200 / 5 = 40$ calls/min) the 12 seconds call is registered ($D = 0.2$ min). If records are stored for 100 days ($P = 100 \cdot 24 \cdot 60 = 144,000$ min), and the safety factor $R = 1.5$, then a storage with volume (C) is needed = 518,400,000 KB = 519 GB.

1.4 Positioning Services

SmartPTT supports outdoor and indoor positioning services.

- For information on outdoor positioning services, see [Outdoor Positioning Services](#).
- For information on indoor positioning services, see [Indoor Positioning Services](#).

1.4.1 Outdoor Positioning Services

SmartPTT supports various types of maps. They are as follows:

- Maps that are available over HTTP.
- Maps that are available in the file storage.
- Maps that are available in the database.

NOTE

The size of the map in the database is limited by the database size. For example, the maximum database size in the SQL Server Express is 10 GB.

For information on different types of maps, see “Map” in *SmartPTT Dispatcher Guide*.

If necessary, SmartPTT supports authorization in the HTTP map server. Authorization settings must be as follows:

- The server must accept credentials in the URL as the clear text (for example, *http://maps.company?password=passwordtext*).
- The server must provide free access to maps (without authorization).

Google Maps and Baidu Maps require a valid API key. To obtain the key, contact the Elcomplus LLC representative in your region.

SmartPTT supports operation with address services. These services display information about the object address by its geographical coordinates on a map. For this, Google and OpenStreetMap address services are used.

1.4.2 Indoor Positioning Services

SmartPTT supports indoor positioning service for continuous control over customer's employees movement inside buildings.

SmartPTT supports the following technologies and equipment of indoor positioning services:

- Motorola Solutions (iBeacon technology).
- BluFi Wireless.
- Kilchherr Elektronik AG.

To display location of customer's employees, files with floor/building plans should be uploaded to SmartPTT Dispatcher. Both raster (bitmap) and vector images are supported. For details, see “Indoor Tracking” in *SmartPTT Dispatcher Guide*.

For information on third party products that are required for Indoor Tracking, see [Third Party Products](#).

1.4.3 Online Map Keys

Some map providers require SmartPTT to use specific keys. This affects the following maps:

- Google Maps. For details, see [Google Map Keys](#).
- Baidu Maps.

Other maps are not affected.

1.4.3.1 Google Map Keys

To use Google Maps in third-party applications, Google forces developers and customers to use API keys. Keys unlock the following features:

- Tracking service.
- Address service.

These features are determined by the following Google API modules:

- Maps JavaScript API.
- Places API.

All of those APIs must be activated in the customer API key.

API Key Generation

To generate API key, the following actions must be performed:

- Project must be created (or exist) in the Google Cloud Platform. For details, see [Creating and Managing Projects](#) in the Google Cloud website.
- In the project settings, the **Application Restrictions** parameter must be set to *None* or *HTTP referrers*.
- In the same project settings, the **API Restrictions** parameter must be set to *Select API*.
- Required API modules must be included in the key:
 - For information on the Maps JavaScript API inclusion to the key, see [Get an API Key \(Maps JavaScript API\)](#) on the Google Maps Platform website.
 - For information on the Places API inclusion to the key, see [Get an API Key \(Places API\)](#) on the Google Maps Platform website.
- Billing **must be** activated for API modules:
 - For information on the Maps JavaScript API billing, see [Maps JavaScript API Usage and Billing](#) on the Google Maps Platform website.
 - For information on the Places API billing, see [Places API Usage and Billing](#) on the Google Maps Platform website.

Important

If you will not use billing, you may lose Google Maps features for reasons beyond the SmartPTT operation. For details, submit a request to the [Google Maps Support Team](#).

If you need an assistance in the key generation, submit a request to the [SmartPTT Technical Support Center](#).

1.5 NTP Services

Some MOTOTRBO network elements support Network Time Protocol (NTP) to adjust dates and times. The elements are as follows:

- SRL series repeaters
- XRC controllers
- XRT voice gateway
- Capacity Max System Server (CMSS)
- MOTOTRBO Network Interface Service (MNIS) host
- Device Discovery and Mobility Service (DDMS) host

It is recommended to connect all computers of the SmartPTT dispatch subsystem to the same NTP server that is used by repeaters or other system infrastructure components. If the NTP server must be one of these computers (for example, the SmartPTT Radioserver host), then either the corresponding service must be configured in its operation system (W32Time) or third-party solutions should be used.

1.6 Power Saving Mode

The function of switching over to power saving mode (sleep mode, hibernation mode or automatic turning off) may be active in the Windows operation system. This feature must be disabled on the SmartPTT Radioserver host.

NOTE

This requirement does not concern the automatic switching over to the screen lock mode that does not affect the performance of the SmartPTT software components.

If dispatch consoles must record voice transmissions or information about events in the database, power saving mode must be turned off on them too.

1.7 Date and Time Format

SmartPTT Radioserver and SmartPTT Dispatcher record to the database date and time of events in Coordinated Universal Time (UTC) format. These date and time formats are not easy to read. Therefore, in SmartPTT Dispatcher they are converted to the following formats:

- The time is displayed in the long time format specified in the operation system.
- The date is displayed in the short date format specified in the operation system.

Date and time formats are specified in the regional settings of the operation system. The settings are applied each time SmartPTT Dispatcher is started and remain unchanged during the session.

1.8 Generating HID with a Standalone Utility

Follow the procedure to obtain the hardware identifier (HID) required to order the SmartPTT license before installing the software.

Prerequisites:

- For each computer with at least one installed SmartPTT component, finalize SmartPTT hosts specifications and operating system language settings.
- Determine the desired license. For information on SmartPTT licenses, contact the Elcomplus LLC representative in your region.
- From the [SmartPTT Technical Support Center](#), obtain the utility for HID generation.

Procedure:

1. Start the utility (HIDSA.EXE file) on the SmartPTT Radioserver host.

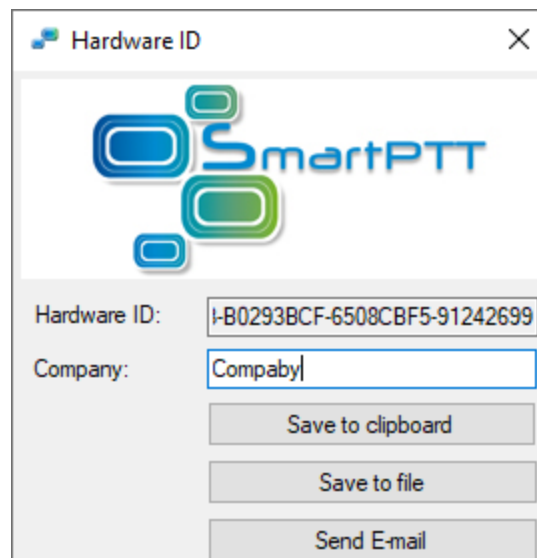

2. Ensure that HID appears in the **Hardware ID** field.
3. Perform one of the following actions:

To copy HID to the clipboard,

click **Save to clipboard**.

To save HID to a file,

click **Save to file**.

To send an email,

perform the following actions:

1. In the **Company** field, type the company name acquiring the license.
 2. Click **Send E-mail**.
-

Postrequisites:

- Send the information to the Elcomplus LLC representative to purchase a license file.
- Install the received license file after installing the software. For details, see [Installing License](#).

2 System Requirements

Certain requirements need to be satisfied in order to successfully install and use SmartPTT. These include hardware, software and infrastructure requirements and are described in the following section.

2.1 Minimum System Requirements for SmartPTT Dispatcher

Software Requirements

SmartPTT Dispatcher can be installed and used on Windows computers only.

OS Family	Version
Windows 10	Pro version 1809 or later (64 bit)
	Enterprise 2016 LTSC (64 bit)
Windows 8.1	Windows 8.1 (64 bit)

NOTE
Windows 8.1 must have the latest updates or the KB 2919355 update. For details, see [Microsoft Support information](#).

NOTE

To ensure operating system security and SmartPTT stable operation, it is recommended to install the latest Windows updates.

Hardware Requirements

Processor:	Intel® Core™ i5 (7th generation or higher) for systems with less than 3,000 subscribers.
	Intel® Core™ i7 for systems with more than 3,000 subscribers or activated GPS/Monitoring/Indoor services.
Memory (RAM):	4 GB for systems with less than 3,000 subscribers.
	8 GB for systems with more than 3,000 subscribers or activated GPS/Monitoring/Indoor services.
Storage:	7200 rpm SATA drive.
	20 GB space for software and database.
Graphics adapter:	1 GB RAM PCI-E or similar CPU-integrated for systems with voice transmission only.

	2 GB RAM PCI-E or similar CPU-integrated for systems with activated GPS/Monitoring/Indoor services.
Monitor:	display size: 23"
	screen resolution: 1366 × 768 px
	color depth: 16 bit
Input/output ports:	1 input port per input device or Human Interface Device (HID).
	1 analog audio output per playback device (speaker or headset).
	1 audio input per microphone.
Sound adapter:	Multichannel sound adapter.
Audio recording device:	A microphone or a headset.
Playback device:	Headphones or a headset.
LAN:	10/100/1000 Mbps Ethernet adapter.
Pointer:	A mouse or a trackball.
Keyboard:	A standard keyboard.

NOTE

These are standard system requirements for SmartPTT Dispatcher. They can change depending on the configuration, complexity and/or workload of the system.

2.2 Minimum System Requirements for SmartPTT Radioserver

Software Requirements

SmartPTT Radioserver can be installed on Windows computers only.

OS Family	Version
Windows Server	Windows Server 2016
	Windows Server 2012 R2
Windows 10	Pro version 1809 or later (64-bit)
	Enterprise 2016 LTSC (64-bit)

OS Family	Version
Windows 8.1	Windows 8.1 (64-bit)

NOTE
Windows 8.1 must have the latest updates or the KB 2919355 update. For details, see [Microsoft Support information](#).

NOTE
To ensure operating system security and SmartPTT stable operation, it is recommended to install the latest Windows updates.

Hardware Requirements

Processor:	Intel® Core™ i5 (7th generation or higher) for systems with less than 3,000 subscribers.
	Intel® Core™ i7 for systems with more than 3,000 subscribers or activated GPS/Monitoring/Indoor services.
Memory (RAM):	4 GB for systems with less than 3,000 subscribers.
	8 GB for systems with more than 3,000 subscribers or activated GPS/Monitoring/Indoor services.
Storage:	7200 rpm SATA drive.
	40 GB space (software and database only).
	190 GB space (software, database, and voice records).
Input/output ports:	1 USB port per each control station connected directly to the computer.
	1 analog audio input/output per each control station connected directly to the computer.
	1 input port per each input device.
Sound card:	External sound cards required to support multiple control stations connected directly to the computer.
LAN:	10/100/1000 Mbps Ethernet adapter.

NOTE
These are standard system requirements for SmartPTT Radioserver. They can change depending on the configuration, complexity and/or workload of the system.

2.3 Networking Requirements

2.3.1 Network Quality

Computer networks where SmartPTT is installed and used, must comply with the following requirements:

Parameter	Value
Packet Loss	Slightly distorted voice: 0.0–2.5 %
	Distorted voice: 2.5–15.0 %
Two-Way Delay	Radio network connection: 0–90 ms
	PBX connection: 0–60 ms
Jitter	Radio network connection: 0–90 ms
	PBX connection: 0–60 ms

IP access to the radio network means the connection to hardware/software solution that provides access to the radio network:

- Connection to an RG-1000e device.
- Connection to repeaters:
 - Master repeater (for voice calls and monitoring).
 - Other repeaters (for monitoring).
- Connection to a computer with a MNIS Data Gateway Relay application.
- Connection to a computer with Device Discovery and Mobility Service (DDMS).
- Connection to the XRC controller (Connect Plus).
- Capacity Max System Server (CMSS) connection.

NOTE

Motorola radio hardware may have more specific requirements for the above parameters. For this information, refer to the respective hardware documentation.

2.3.2 Bandwidth Requirements

Computer networks where SmartPTT is installed and used must provide specific bandwidth between the computer with SmartPTT Radioserver and the other IP devices of the dispatch system. All following requirements are applicable to one-way transmissions.

Voice transmission

All following requirements are applicable to a single voice stream.

Source/Target	Minimum	Comments
SmartPTT Dispatcher application	13 kbps	For DMR vocoder
	100 kbps	For G.711 vocoder
RG-1000e radio gateway	from 65 kbps	Exact value depends on vocoder parameters
Master repeater	20 kbps	
PBX	65 kbps	For G.729 or Speex vocoders
	100 kbps	For G.711 vocoder
Applications that use SmartPTT WebSocket	from 65 kbps	For each of the following applications: <ul style="list-style-type: none"> • SmartPTT Web Client • SmartPTT Mobile • Third Party app over SmartPTT Server API Exact value depends on vocoder parameters.

Required bandwidth should be increased if you use the bridging, cross patches, conference calls, or voice communication between dispatchers. For details on increased bandwidth, contact Elcomplus LLC representative in your region.

If you have an alternate/redundant SmartPTT Radioserver, the bandwidth to that computer must comply with the synchronization settings between the main and redundant servers.

Voice traffic between SmartPTT Dispatcher applications (the Dispatchers feature) is not sent to SmartPTT Radioserver. To provide this feature, the bandwidth between dispatcher computers must be 65 kbps or more per each configured contact.

Data transmissison

In SmartPTT, data transmissison includes text messages, indoor and outdoor location, telemetry information and control commands.

Source/Target	Minimum	Comments
SmartPTT Dispatcher application	3.5 kbps	For Enhanced CSBK location data from 10 subscribers and location update period 7.5 s
Master repeater	20.0 kbps	For each repeater without a revert channel
	45.0 kbps	For each repeater with a revert channel
Remote MNIS host	20.0 kbps	For each repeater without a revert channel

Source/Target	Minimum	Comments
	45.0 kbps	For each repeater with a revert channel
XRC controller	20.0 kbps	For each repeater without a revert channel
	45.0 kbps	For each repeater with a revert channel
Avigilon server	3150 kbps	<p>For each camera.</p> <p>This value is obtained based on the following conditions:</p> <ul style="list-style-type: none"> Resolution is 1920 x 1080. FPS is 25. Service packets in stream no more than 5% of the video stream. <i>H.264 Base codec - medium quality.</i> Average dynamics of the image change.

Bandwidth must be increased if you activate and use the Bridging feature in SmartPTT Radioserver, create a cross patch, or organize a conference call.

If you have a redundant SmartPTT Radioserver, the bandwidth to that computer must comply with the synchronization settings between the main and redundant servers.

Monitoring service

Source/Target	Minimum	Comments
SmartPTT Dispatcher application	42 kbps	For each configured repeater if the Monitoring panel is closed
	45 kbps	For each configured repeater if the Monitoring panel is opened
Repeater	42 kbps	For each configured repeater

2.4 Support and Compatibility

2.4.1 MOTOTRBO Infrastructure

SmartPTT supports the following MOTOTRBO firmware and software:

Firmware/Software	Version	Comments
Subscriber radio Firmware	R02.11.XX	
	R02.10.XX	
	R02.09.XX	
Repeater Firmware	R02.11.XX	
	R02.10.XX	
	R02.09.XX	
Control Station Firmware	R02.11.XX	
	R02.10.XX	
	R02.09.XX	
MOTOTRBO Network Interface Services Software (MNIS)	R2.105.X	Provides data transmission in IP Site Connect (NAI), Capacity Plus (NAI), and Linked Capacity Plus
	R2.100.X	
	R2.90.X	
Device Discovery and Mobility Service Software (DDMS)	R3.100.X	Provides radio registration information in IP Site Connect (NAI), Capacity Plus (NAI), and Linked Capacity Plus
	R3.70.X	
XRC Firmware	R02.80.XX	Connect Plus only
Capacity Max System Server (CMSS) Firmware	R02.11	
	R02.10	
	R02.09	

Additional information on infrastructure:

- Within the radio system, all repeaters, subscriber radios and control stations should use the same or compatible firmware versions.
- If you activate the Bridging feature, you should bridge only the radio fleet objects which are associated with the same or compatible firmware versions.
- Access and operation in radio systems for SmartPTT require separate licensing.
- SmartPTT does not support voice calls (including emergency calls) in Connect Plus and Capacity Max over control stations.

2.4.2 Elcomplus Products

SmartPTT is compatible with the following Elcomplus LLC products:

Product	Version	Comments
Radio gateway RG-1000e	R3.X	Current version of firmware used on the device for control station remote connection and operation.
	R2.2	Previous version of firmware used on the device.
SmartPTT File Transfer	2.0	Application for file transmission over the radio network.
SmartPTT SCADA	1.1	New version of software SmartPTT extension for data acquisition and remote control in civil engineering.
	1.0.1	Software SmartPTT extension for data acquisition and remote control in civil engineering.

2.4.3 Third Party Products

SmartPTT is compatible with a range of third-party products. Below you will find a list of hardware and software products that proved to be compatible with the SmartPTT applications.

Database Management Systems

SmartPTT uses Microsoft SQL Server as a database. The following versions are supported:

- Microsoft SQL Server 2014 Express
- Microsoft SQL Server 2008 R2 Enterprise

For information on use of other Microsoft SQL Server versions and editions, submit a request to [SmartPTT Technical Support Center](#).

Option Boards

- Connect-RTLS RF800 (BluFi Wireless).
- K-TERM 44 (Kilchherr Elektronik AG).

Beacons

- Connect-RTLS RF800 (BluFi Wireless).
- K-TERM 70IC Beacon Transmitter (Kilchherr Elektronik AG).
- iBeacons.

Option Boards Software

SmartPTT supports MOTOTRBO™ option boards programmed using Tallysman Sprite Configurator. For specific features, the corresponding software versions are required:

- Version 0.2.68 for the Heartbeats feature.
- Version 0.3.16 for the Movement Reports Restoration feature.

These software versions are incompatible and they do not provide both features to one option board.

Sound cards

- Internal PCI-E Sound Blaster Audigy RX.
- External Sound Blaster X-Fi Go.
- ESI MAYA44XTe.
- ICON Digital Cube Pro USB.

Accessories

- Desktop USB microphone [D-9 by Holmco](#)
- Desktop USB microphone [PS12 by pei tel](#)
- Desktop microphone [DM-160 by CXD](#)
- Push-to-talk button [PTT-13 by Imtradex](#)
- USB corded headsets [Blackwire C310-M and C320-M by Plantronics](#)
- Yellow foot switch [X-keys XK-3 USB Switch Interface by P.I. Engineering](#)

Hardware

- SmartPTT Dispatcher can be installed and used on [BeFREE 10](#) computers.
- SmartPTT supports the IP Gear Claro 30 SIP-gateway (by ESTel) for access to analog telephone networks.
- SmartPTT can connect to [NexLog recorders](#) running under NexLog Recorder Software 2.8.2.
- SmartPTT can connect to [Avigilon](#) system cameras using the [Avigilon Control Center Server 7](#) software.

2.5 Audio File Requirements

Audio files that will be used in SmartPTT must comply with specific requirements. This implies the following features:

- Voice notifications.
- Sounds used in SmartPTT Radioserver rules.

Parameter	Value
File format	MP3, OGG, or WAV Important File format and its extension must be the same.
Encoding algorithm	16-bit PCM
Sample rate	MP3: 8–48 kHz OGG: 8–48 kHz WAV: 8–192 kHz
Number of audio channels	single (mono audio)
Maximum volume level	–22 dBFS (–10 dBm)
Audio frequency parameters	range: 300–3400 Hz spectrum: continuous (not isolated tones) Important SmartPTT does not deliver single tone audio as well as isolated tones within audio.
Audio length	must not exceed transmission duration in radio network (~60 seconds)

3 Software Installation

Installation program of the SmartPTT dispatch software includes the following components:

- SmartPTT Radioserver (includes SmartPTT Radioserver Configurator).
- SmartPTT Dispatcher.
- Input Sound Configuration Utility (installs together with SmartPTT Radioserver).
- Web Client (installs together with SmartPTT Radioserver).
- Remote Assistance. The application provides you a control over the remote access to the computer performed by the technical support engineer.
- Microsoft SQL Server 2014 Express.

To provide SmartPTT operation, installation package includes the following service packages:

- Microsoft .NET Framework 4.6.2.
- Microsoft Visual C++ 2015 Redistributable.
- MOTOTRBO Radio Driver. The driver installs together with SmartPTT Radioserver and provides the support of MOTOTRBO control stations.
- Windows Driver Package. The package contains supplemental programs required by the MOTOTRBO Radio Driver.

The packages are installed only if required on the computer.

3.1 Installing on New Computers

Follow the procedure to perform installation on the computer that never hosted SmartPTT software.

Prerequisites:

- Log on to Windows as an administrator.
- Copy the installation file (SmartPTTSetup.exe) to the computer.

Procedure:

1. Start the installation file.



2. In the welcoming window, select the installation language:
 - a. Next to the **Setup language** heading, click a current language.
 - b. From the dialog box, select the required language, and then click **Apply**.
 - c. In the welcoming window, click **Next**.

- If .NET Framework is required to be installed, agree to install it.

Important

For Window 8.1, restart your computer after the .NET Framework installation. For other Windows versions restart may not be required.

- After .NET Framework is installed, restart the installation file.
- Select the installation language again. Then click **Next**.
The **License Agreement** window appears.

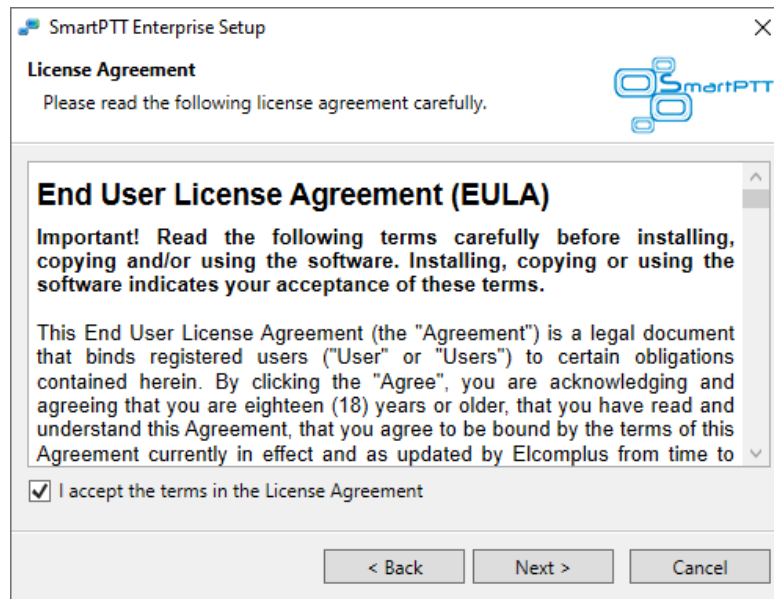

- In the window that appeared, select **I accept the terms in the License Agreement**, and then click **Next**.
The **Custom Setup** window appears.

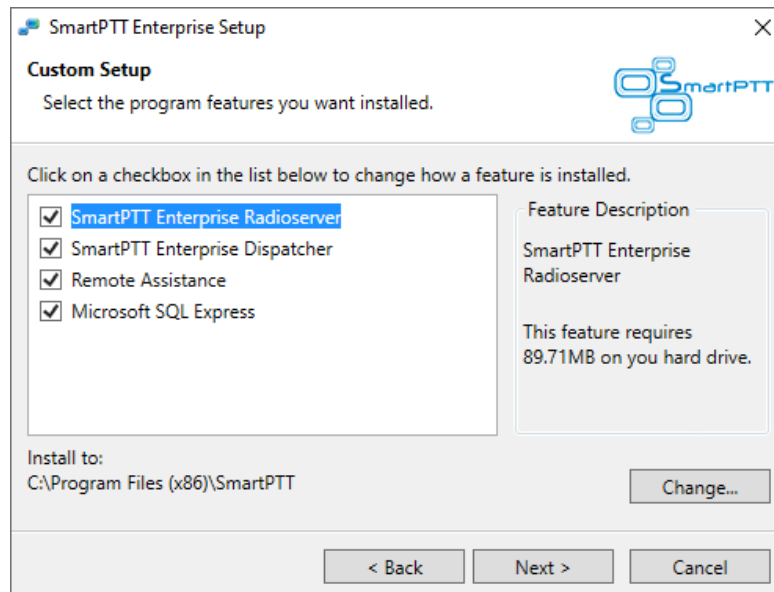

7. In the window that appeared, select components that will be installed:
 - a. Select the software component that must be installed on the computer.

NOTE

If the component is already installed, it will be selected and unavailable. It will not be re-installed.

- b. (Optional) For each of the required component, change the installation path:
 - i. Click **Change**.
 - ii. In the dialog box, select the required path.
 - iii. Click **OK**.

Important

It is recommended to keep default installation paths unchanged.

- c. In the **Custom Setup** window, click **Next**.
The **Ready to Install the Program** window appears.



8. In the window that appeared, look through the installation summary to check the data correctness. Then click **Install**.
When the installation completes, the **Setup Completed** window appears.



9. In the window that appeared, click **Finish** to exit the installation program.

Postrequisites:

Restart the computer to guarantee that all Windows configuration changes are applied.

3.2 Modifying Installed Software

Follow the procedure to modify the SmartPTT components installed on the computer.

Prerequisites:

- Log on to Windows as an administrator.
- Copy the installation file (SmartPTTSetup.exe) to the computer.

Procedure:

1. Start the installation file.
2. In the welcoming window, click **Next**.
The **Program Maintenance** window appears.

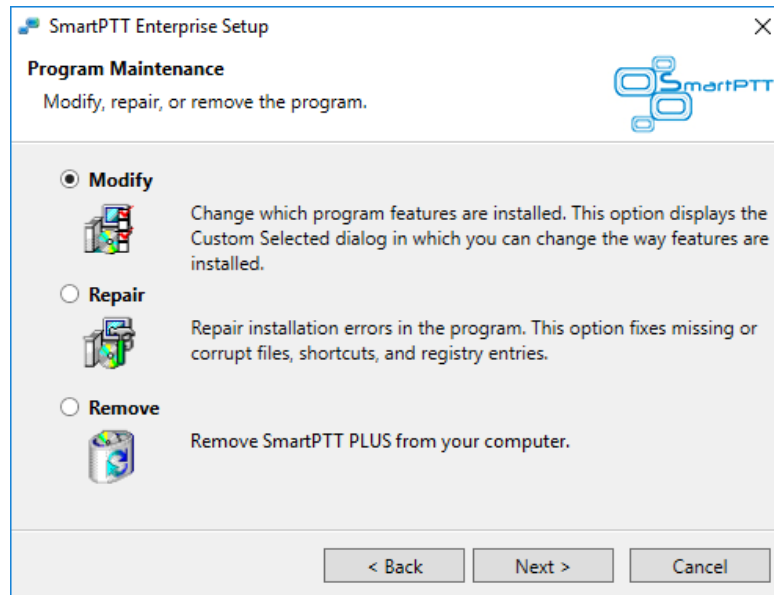

3. In the window that appeared, perform one of the following actions:
 - To install additional components, click **Modify**.
 - To repair the incorrectly installed software, click **Repair**.
 - To remove one or several software components, click **Remove**.
4. Click **Next**, and then follow the instructions provided by the installation program.

3.3 Dispatch Software Upgrade

If you start **SmartPTTSetup.exe** on the computer, that already has earlier SmartPTT software (except Web Client), the information window appears that offers you to upgrade your SmartPTT software. Before you start an upgrade, you are recommended to perform the following actions:

- Export SmartPTT Radioserver settings to the configuration file.
- For SmartPTT Dispatcher, save settings to the configuration file.

WARNING

Decision to include databases in the configuration files must be made by the maintenance engineer. Including databases into the file may increase its size up to many gigabytes.

After this, you should start **SmartPTTSetup.exe** to upgrade the software. Installation program should detect the earlier software versions automatically. If it does not, your SmartPTT version is too early. In this case, you should uninstall it manually. This includes both SmartPTT Radioserver and SmartPTT Dispatcher.

Important

The installation program does not provide automatic update for currently used SmartPTT Dispatcher.

After an upgrade completes, restart the computer and perform the following actions:

- Import SmartPTT Radioserver settings from the configuration file.
- For SmartPTT Dispatcher, restore settings from the configuration file.

3.4 Configuring Antivirus Software

If antivirus software (anti-malware) is installed and used on the radioserver and/or dispatch console host, it can prevent SmartPTT executable (.exe) files from starting. To avoid this, you should configure antivirus software to start the following executable files without checking:

Component	File Path
SmartPTT Radioserver	\<installation folder>\Server\DebugInfoCollector.exe
	\<installation folder>\Server\GrantSqlAccess.exe
	\<installation folder>\Server\HID.exe
	\<installation folder>\Server\RadioService.exe
	\<installation folder>\Server\RSConfigurator.exe
SmartPTT Dispatcher	\<installation folder>\Client\CefSharp.BrowserSubprocess.exe
	\<installation folder>\Client\Client.exe
	\<installation folder>\Client\DebugInfoCollector.exe
	\<installation folder>\Client\GrantSqlAccess.exe

To determine the DBMS files that should be allowed to start without checking, contact [Microsoft Support](#).

4 Base Configuration

Basic SmartPTT configuration includes actions that can be performed despite of the radio or other communication system connection. Note that those actions may provide additional requirements to the dispatch and radio system infrastructure, IP address management, network ports management, radios identifications, etc.

4.1 DBMS Configuration

The document provides information on the database management system (DBMS) using the official applications provided by the DBMS developer. Those applications provide graphical user interface for DBMS configuration. The applications are as follows:

- Microsoft SQL Server Configuration Manager (included in the SmartPTT installation package).
- Microsoft SQL Server Management Studio (**not** included in the SmartPTT installation package).

All the related screenshots are presented for Microsoft SQL Server Express. Customer's DBMS may be different.

Configuration Overview

To configure DBMS, the following actions must be performed:

- DBMS autostart must be configured. For details, see [Configuring DBMS Autostart](#).
- Remote access must be allowed. For details, see [Configuring Remote DBMS Access](#).
- *(Optional)* User accounts must be created to provide Windows-independent authentication. For details, see [Adding SQL Server Users](#).
- DBMS memory consumption must be limited. For details, see [Limiting DBMS Memory Use](#).
- Network traffic must be unlocked for DBMS. For details, see [Firewall Configuraiton](#).

4.1.1 Configuring DBMS Autostart

Follow the procedure to configure automatic start of the DBMS service after computer restart. This will reduce the time of system startup after DMBS host restart.

Prerequisites:

Start SQL Server Configuration Client (SSCC) on the DBMS host. For details, see [SQL Server Configuration Manager](#) in the *Microsoft Docs* portal.

Procedure:

1. In SSCC, in the left pane, expand **SQL Server Configuration Manager (local)**, and then click **SQL Server Services**.
2. Stop DBMS services:
 - a. In the right pane, right-click **SQL Server**, and then (from the action menu) select **Stop**.

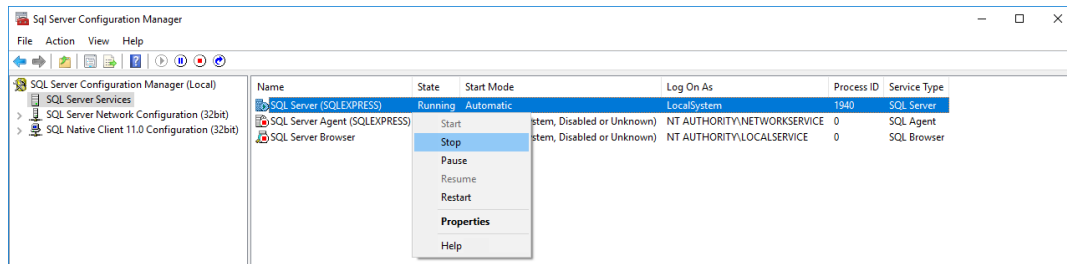

- b. Repeat [step 2a](#) for **SQL Server Browser**.
3. Configure DBMS autostart:
 - a. Right-click **SQL Server**, and then (from the action menu) select **Properties**.
The **Properties** window appears.

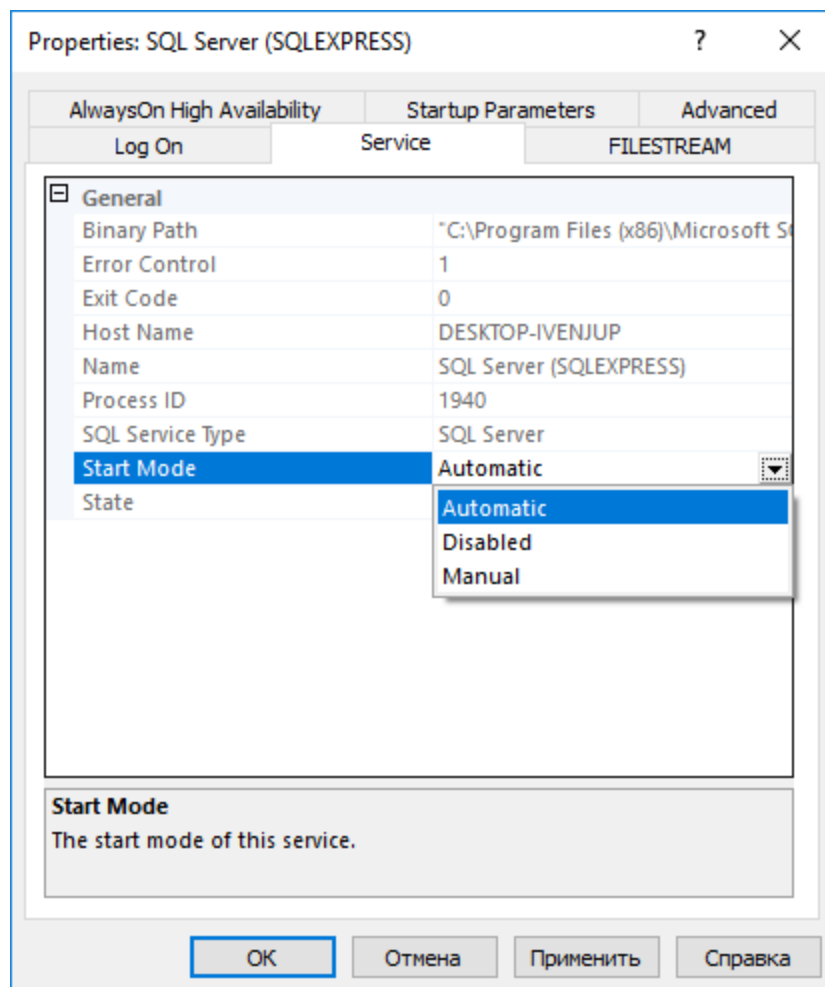

- b. In the window that appears, open the **Service** tab.
- c. On the tab, in the **Start Mode** list, click the current value, and then select *Automatic*.
- d. In the **Properties** window, click **OK** to apply changes and close the window.
4. Repeat [step 3](#) for the **SQL Server Browser** service.
5. Start DBMS services:
 - a. In the right panel, right-click **SQL Server**, and then (from the action menu) select **Start**.

- b. Repeat [step 5a](#) for **SQL Server Browser**.

4.1.2 Configuring Remote DBMS Access

Follow the procedure to allow remote access to the DBMS.

Prerequisites:

Start SQL Server Configuration Client (SSCC) on the DBMS host. For details, see [SQL Server Configuration Manager](#) in the *Microsoft Docs* portal.

Procedure:

1. Allow TCP/IP protocol for communication with DBMS:
 - a. Start SSCC.
 - b. In SSCC, in the left pane, expand **SQL Server Configuration Manager (Local)** → **SQL Server Networks Configuration**, and then select **Protocols for <DBMS Name>**.

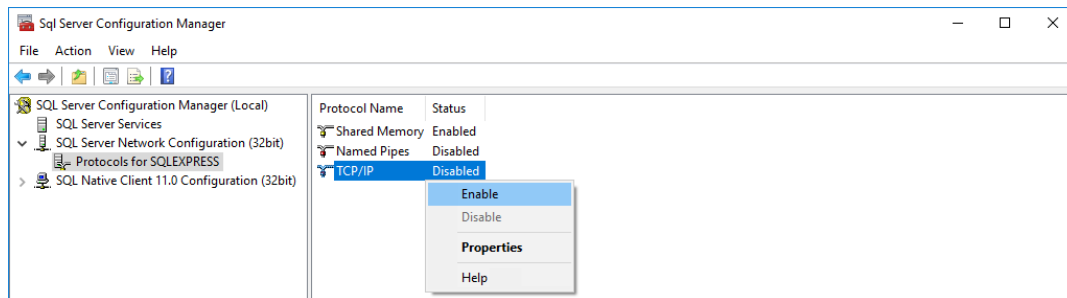

- c. In the right pane, right-click **TCP/IP**, and then (from the actions menu) select **Enable**.
 - d. In the warning dialog box, click **OK**.
 - e. Restart DBMS:
 - i. In the left pane, click **SQL Server Services**.
 - ii. In the right pane, right-click **SQL Server**, and then (from the actions menu) select **Restart**.
2. Start SSMS, and then connect to the required DBMS.
3. Open the **Object Explorer** panel.
4. On the panel, right-click **<Computer Name>\<DBMS Name>**, and then (from the action menu) select **Properties**.
The **Server Properties** window appears.
5. In the window that appears, modify authentication settings:
 - a. In the left pane of the window, click **Security**.
Security settings appear in the right pane.

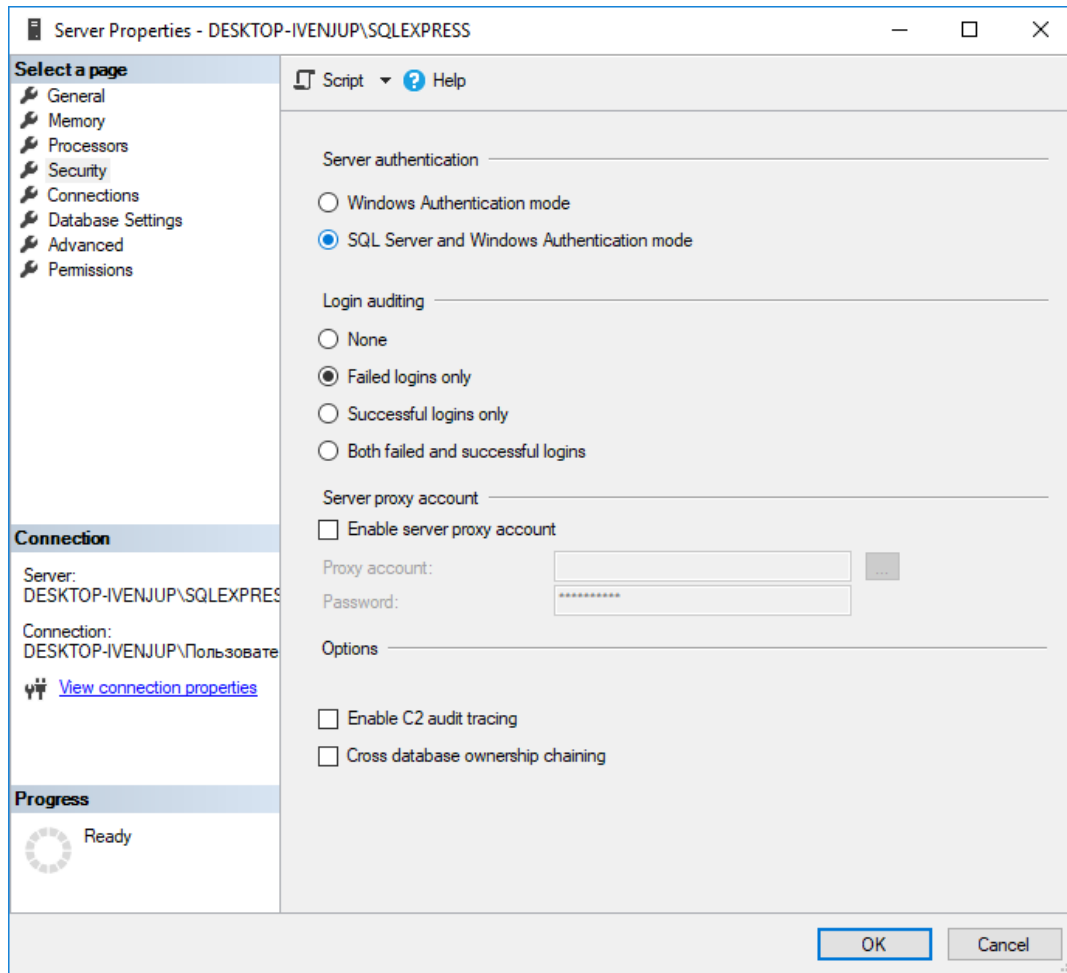

- b. In the right pane, click **SQL Server and Windows Authentication mode**.
6. Configure the remote access parameter for the DBMS:
- a. In the left pane, click **Connections**.

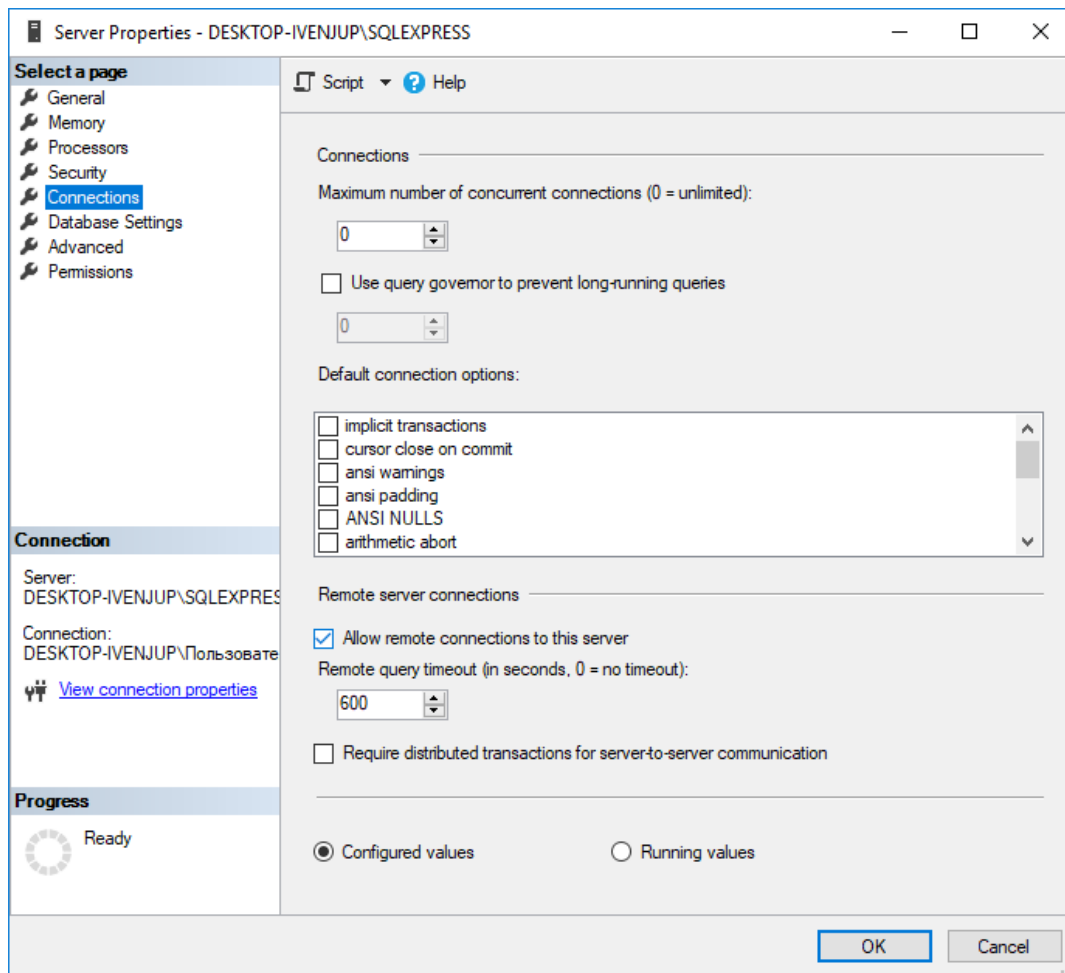

- b. In the right pane, in the **Maximum Number of Concurrent Connections** field, enter one of the following values:

To allow unlimited number of connections, enter *0*.

To limit the maximum number of simultaneous connections, enter the required number of connection.

- c. In the right pane, in the **Remote server connections** area, select **Allow remote connections to this server**.
- d. (Optional) In the **Remote query timeout** field, enter the request timeout.
- e. In the window, click **OK** to apply changes and close the window.
7. In the **Object Explorer** panel, right-click **<Computer Name>\<DBMS Name>**, and then (from the actions menu) select **Restart**.

4.1.3 Adding SQL Server Users

Follow the procedure to add a user to the DBMS and use its credentials for DBMS (SQL) authentication.

Prerequisites:

- Determine user login and password.
- Connect to the DBMS using SQL Server Management Studio (SSMS).

Procedure:

1. In SSMS, open the **Object Explorer** panel.
2. On the **Object Explorer** panel, expand <Computer Name>\<DBMS Name> → **Security**.
3. Right-click **Logins**, and then (from the actions menu) select **New Login**.
The **Login - New** window appears.
4. In the window that appears, set user credentials:
 - a. In the left pane, click **General**.

The screenshot shows the 'Login - New' dialog box with the following details:

- Left Pane:** 'Select a page' with 'General' selected. Below it, 'Connection' shows 'Server: DESKTOP-IVENJUP\SQLEXPRES' and 'Connection: DESKTOP-IVENJUP\Пользовате'. 'Progress' shows 'Ready'.
- Main Area:**
 - Login name:** username
 - Authentication:** SQL Server authentication
 - Password:** [Masked]
 - Confirm password:** [Masked]
 - Specify old password
 - Old password:** [Empty]
 - Enforce password policy
 - Enforce password expiration
 - User must change password at next login
 - Mapped to certificate
 - Mapped to asymmetric key
 - Map to Credential
 - Mapped Credentials Table:**

Credential	Provider
 - Default database:** master
 - Default language:** <default>

- b. In the right pane, in the **Login name** field, enter user login.
- c. Click **SQL Server authentication**.
- d. In the **Password** field, enter user password.

- e. In the **Confirm password** field, enter user password again.
- f. Modify password policy settings:

To make password policy settings compliant with the operating system settings,

perform the following actions:

1. Select **Enforce password policy**.
2. Clear **Enforce password expiration**.
3. Clear **User must change password at next login**.

To turn off password policy for the user,

clear **Enforce password policy**.

5. Configure user rights:

- a. In the left pane, click **Server Roles**.

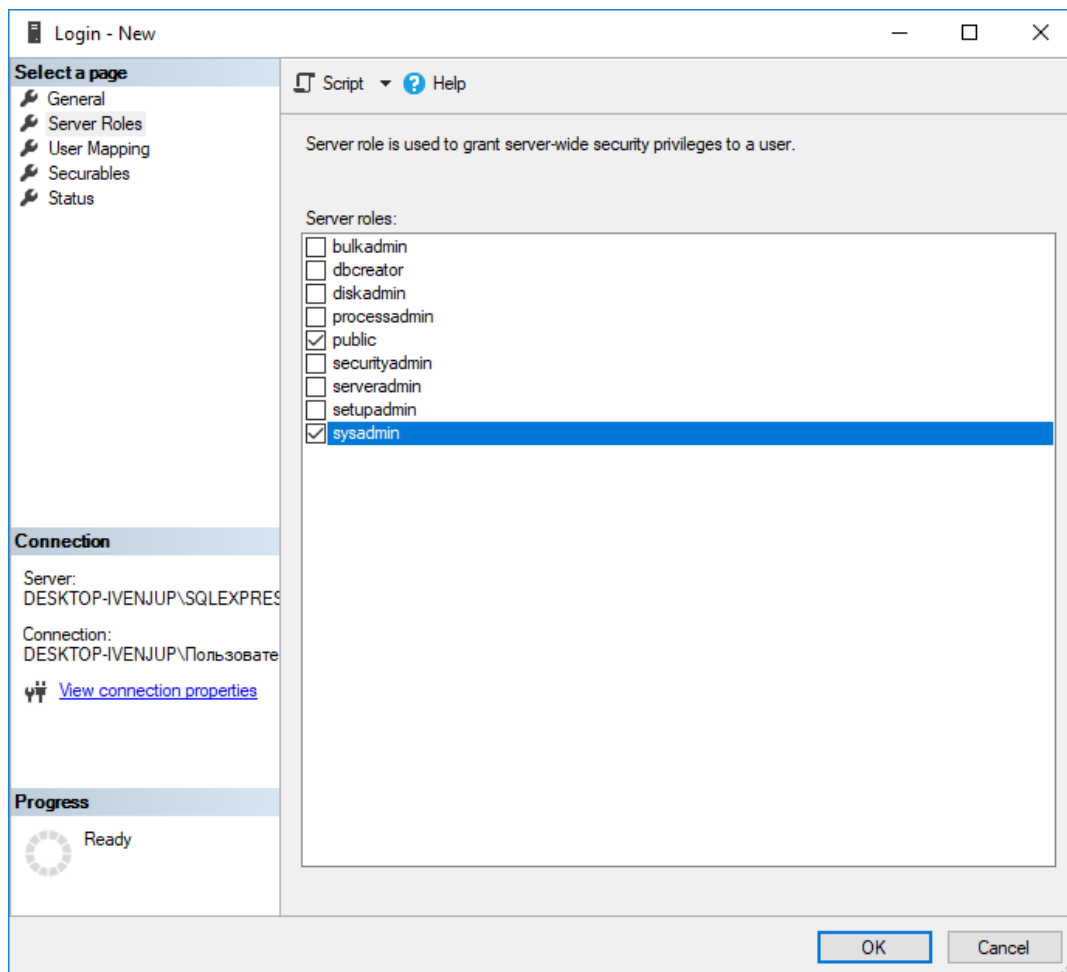

- b. In the right pane, in the **Server Roles** area, select **sysadmin**.

6. Configure user status:

- a. In the left pane, click **Status**.

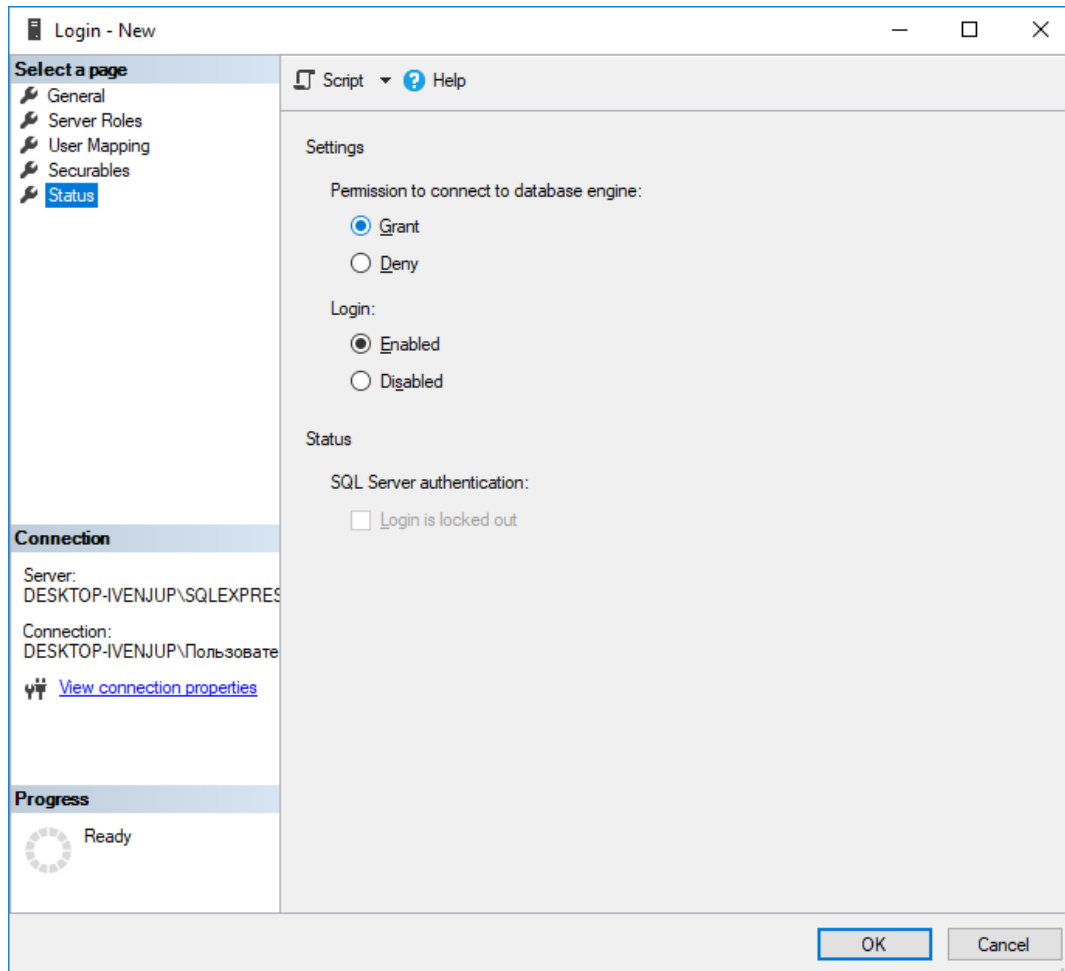

- b. In the right pane, in the **Permission to connect to database engine** area, click **Grant**.
 - c. In the **Login** area, click **Enabled**.
7. In the **Login - New** window, click **OK** to create the user account and close the window.
 8. On the **Object Explorer** panel, right-click **<Computer Name>\<DBMS Name>**, and then (from the actions menu) select **Restart**.

4.1.4 Limiting DBMS Memory Use

Follow the procedure to limit the size of Random-Access Memory (RAM) used by DBMS. By default, DBMS is able to consume all the available RAM. This may result in a serious decrease in computer performance, especially if DBMS is installed on the same computer as another server application.

WARNING

Modify the settings only after consult with your system administrator.

Prerequisites:

Connect to the required DBMS using SQL Server Management Studio (SSMS).

Procedure:

1. In SSMS, open the **Object Explorer** panel.

- On the panel, right-click **<Computer Name>\<DBMS Name>**, and then (from the actions menu) select **Properties**.

The **Server Properties** window appears.

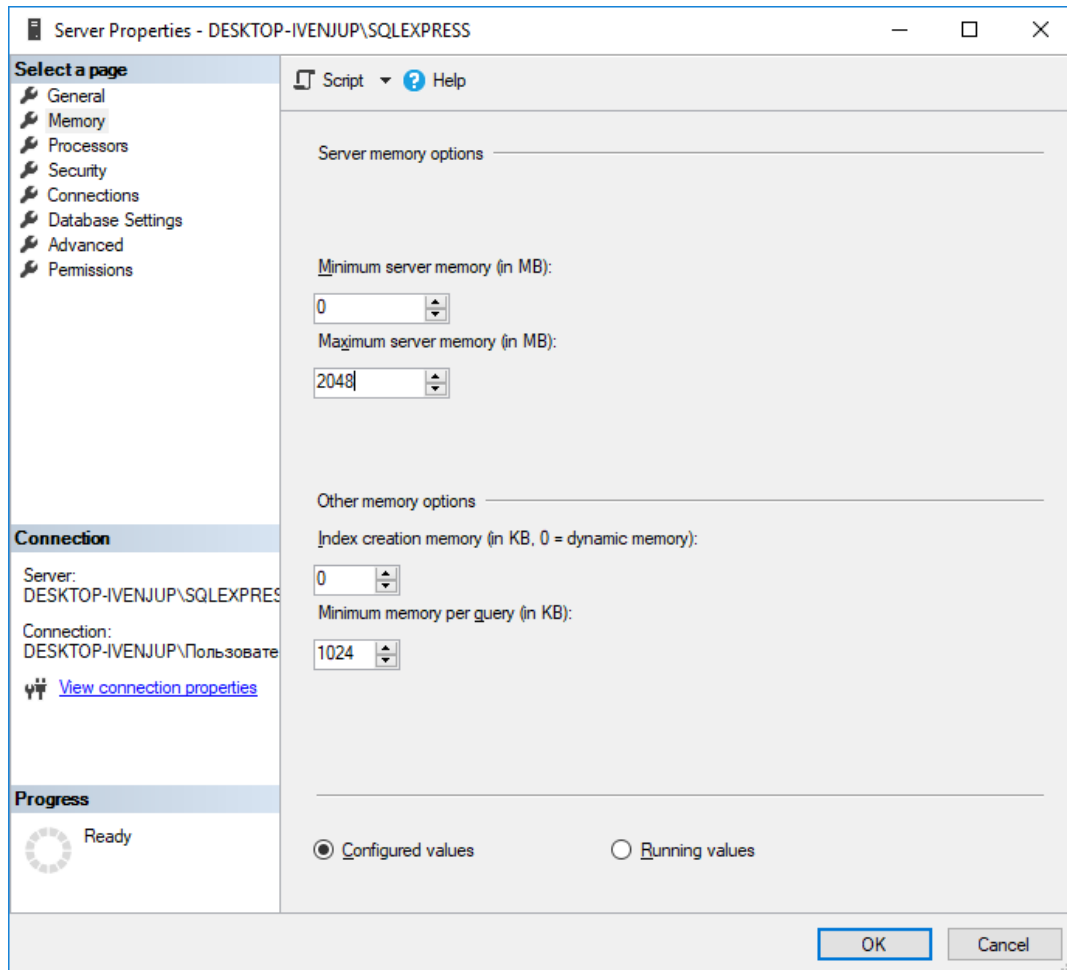

- In the window that appears, in the left pane, click **Memory**.
- In the right pane, in the **Maximum Server Memory** field, enter the maximum RAM size that will be available to DBMS.
- In the **Server Properties** area, click **OK**.
- In the **Object Explorer** panel, right-click **<Computer Name>\<DBMS Name>**, and then (from the actions menu) select **Restart**.

4.2 Licensing

To unlock SmartPTT Radioserver Configurator tools, SmartPTT features must be licensed. Licensing should be performed in the Radioserver Configurator and on each dispatch console.

Licensing includes the following actions:

- Hardware ID generation. Hardware ID is required to order SmartPTT licenses. The ID can be obtained in one of the following ways:

- Using SmartPTT Radioserver Configurator (after the software installation). For details, see [Generating Hardware ID](#).
- Using standalone utility. For details, see [Generating HID with a Standalone Utility](#).
- License file installation. For details, see [Installing License](#).

4.2.1 Generating Hardware ID

Follow the procedure to generate the hardware ID (HID) required to order a SmartPTT license file.

NOTE

HID can also be obtained before SmartPTT installation using a standalone utility. For details, see [Generating HID with a Standalone Utility](#).

Prerequisites:

Finalize the computer hardware and operating system language settings.

Procedure:

1. In SmartPTT Radioserver Configurator, open the **Settings** tab.
2. In the left pane, select **Licenses**.

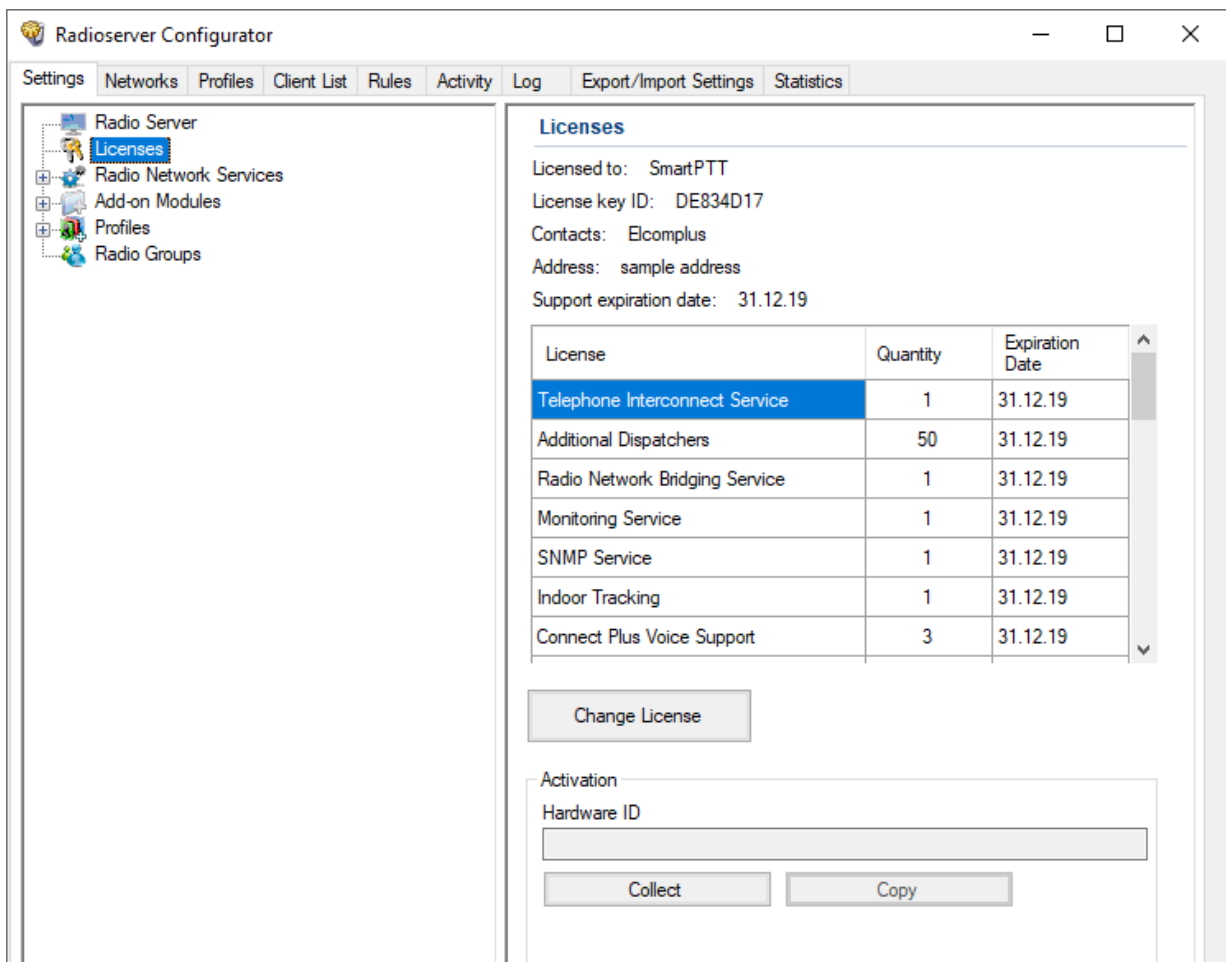

3. In the right pane, in the **Activation** area, click **Collect**.
A string of characters appears in the **Hardware ID** field.

- Click **Copy** to copy the hardware ID to the clipboard.

Postrequisites:

Send the hardware ID to Elcomplus LLC to receive the license file.

4.2.2 Installing License

Follow the procedure to install SmartPTT license.

Prerequisites:

Obtain the SmartPTT license file (.spttlx).

Procedure:

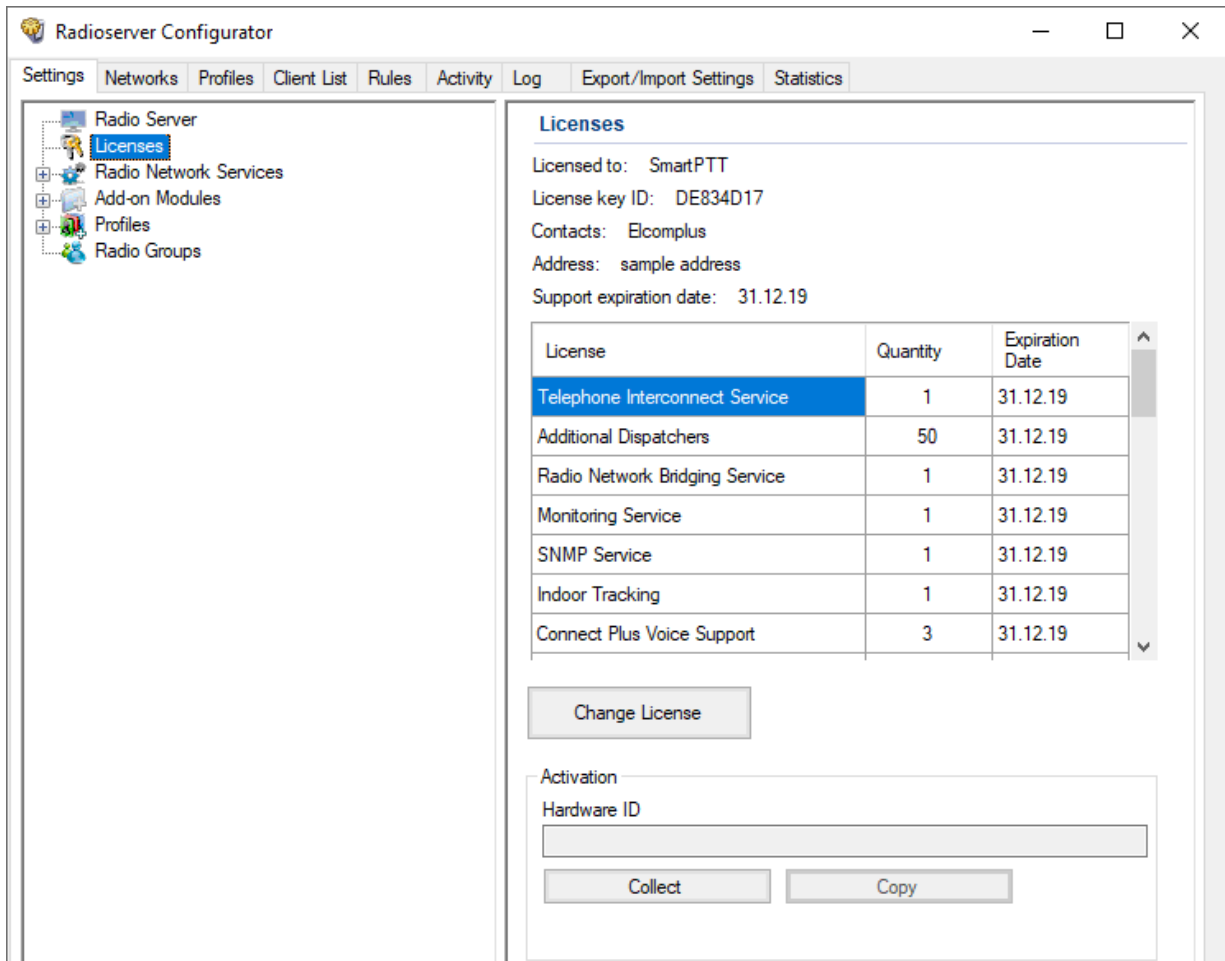

- In SmartPTT Radioserver Configurator, open the **Settings** tab.
- In the left pane, select **Licenses**.



- Click **Change License**.
File selection window appears.
- In the window that appears, select the license file and click **Open**.
The **License Installation** window appears.

5. Ensure that the licensed services and their expiration dates are correct and click **Apply**. Otherwise, click **Cancel** and select a different license file or contact [SmartPTT Technical Support Center](#).
The new license parameters appear in the right pane.
6. To save changes, at the bottom of the SmartPTT Radioserver Configurator window, click **Save Configuration** ().

Postrequisites:

To apply changes immediately, at the bottom of the SmartPTT Radioserver Configurator window, click **Start** () or **Restart** ().

4.2.3 Viewing License Items

Follow the procedure to view items of the installed license file. The procedure may be required to determine if specific features are available or unavailable in SmartPTT.

Important

This document does not contain exact license item names. If you need assistance in matching license item names and SmartPTT features, submit a request to [SmartPTT Technical Support Center](#).

Prerequisites:

Install the SmartPTT license file. For details, see [Installing License](#).

Procedure:

1. In SmartPTT Radioserver Configurator, open the **Settings** tab.

- In the left pane, click **Licenses**.

The license information appears in the right pane.

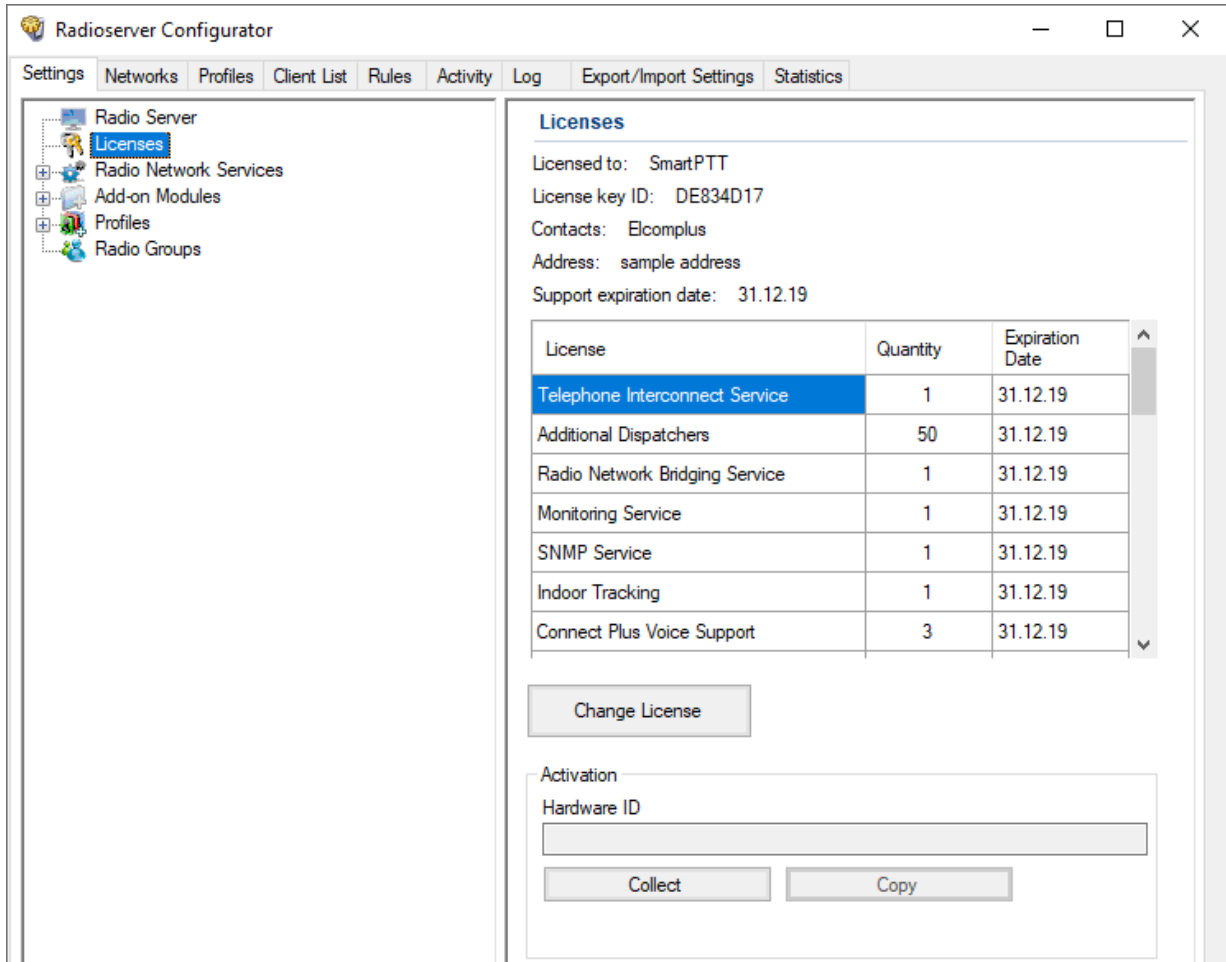

- In the upper part of the right pane, perform the following actions:

To view the licensee name, _____ in the **Licensed to** entry, view the name.

To view the license ID, _____ in the **License key ID** entry, view the ID.

To view the contact information written to the license, _____ in the **Contacts** entry, view the contact information.

To view the licensee address, _____ in the **Address** entry, view the address.

To view the last date of the SmartPTT upgrade installation, _____ in the **Support expiration date** entry, view the date.

- In the table below, view the available license items. Use scrollbar if required.
 - In the **License** column, view the license item name.
 - Next to the desired license item, in the **Quantity** column, view the quantity of the purchased license items.
 - Next to the desired license item, in the **Expiration Date** column, view the last date of the feature provision.

4.3 Configuring Radioserver

Follow the procedure to configure the main (primary) SmartPTT radioserver.

Prerequisites:

- From radio codeplugs, obtain information on the following commands support:
 - Radio Disable.
 - Radio Inhibit.
- Obtain Radio IDs that must be accessible to a radioserver.

Procedure:

1. In SmartPTT Radioserver Configurator, open the **Settings** tab.
2. In the left pane, click **Radio Server**.
The SmartPTT Radioserver settings appear in the right pane.

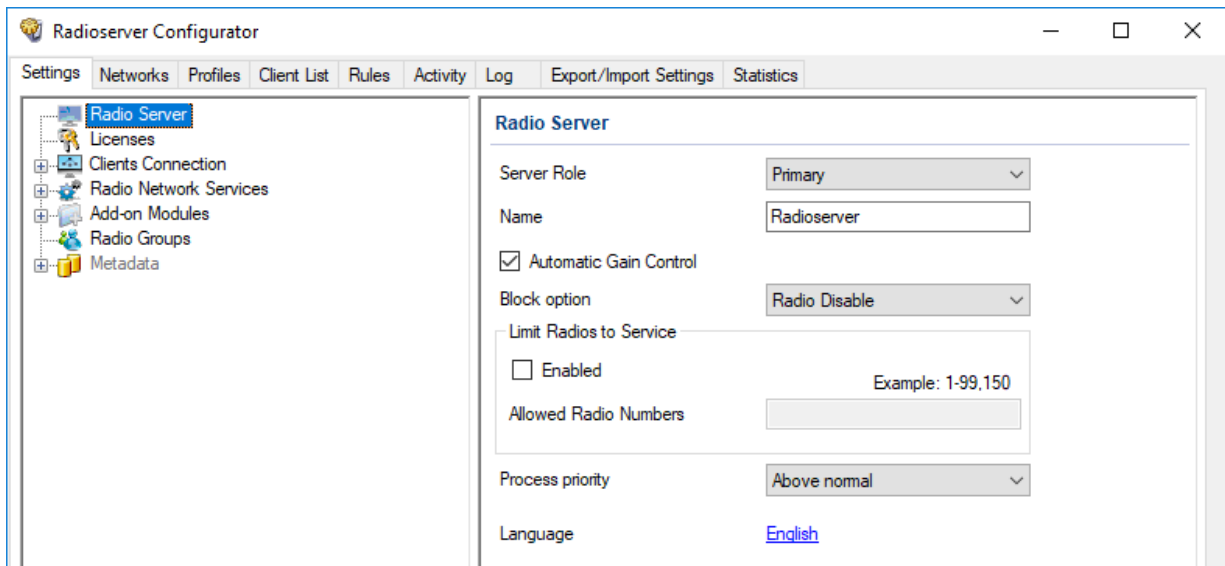

3. From the **Server Role** list, select *Primary*.
4. (Optional) In the **Name** field, type the desired radioserver name.
5. (Optional) Select the **Automatic Gain Control** check box to automatically adjust the incoming calls volume.
6. In the **Block option** field, select the appropriate radio command that blocks radios:

If radios support the Radio Enable command,	select <i>Radio Disable</i> .
If radios support the Radio Inhibit command,	select <i>Deny Channel</i> .

7. (Optional) In the **Limit Radios to Service** area, configure the list of radios that will be available to dispatchers:
 - a. Select the **Enabled** check box.
 - b. In the **Allowed Radio Numbers** field, type the desired Radio IDs.

Important

If a dispatcher adds a radio that is not in the list, the radio will be inactive and inaccessible.



- From the **Process priority** list, select the radioserver process priority relative to other processes on the computer.

Important

If *Real time* is selected from the list, all computer resources will be given to SmartPTT Radioserver, which may make the computer operating system unstable.

- To save changes, at the bottom of the SmartPTT Radioserver Configurator window, click **Save Configuration** ().

Postrequisites:

To apply changes immediately, at the bottom of the SmartPTT Radioserver Configurator window, click **Start** () or **Restart** ().

4.3.1 Managing Radio Groups

Follow the procedure to add, edit, or delete a group of radios that may be needed for various radioserver subservices configuration.

Important

Do not confuse radio groups and talkgroups.

Prerequisites:

Obtain Radio IDs that must be configured for various purposes.

Procedure:

- In SmartPTT Radioserver Configurator, open the **Settings** tab.
- In the left pane, click **Radio Groups**.
The radio group settings appear in the right pane.

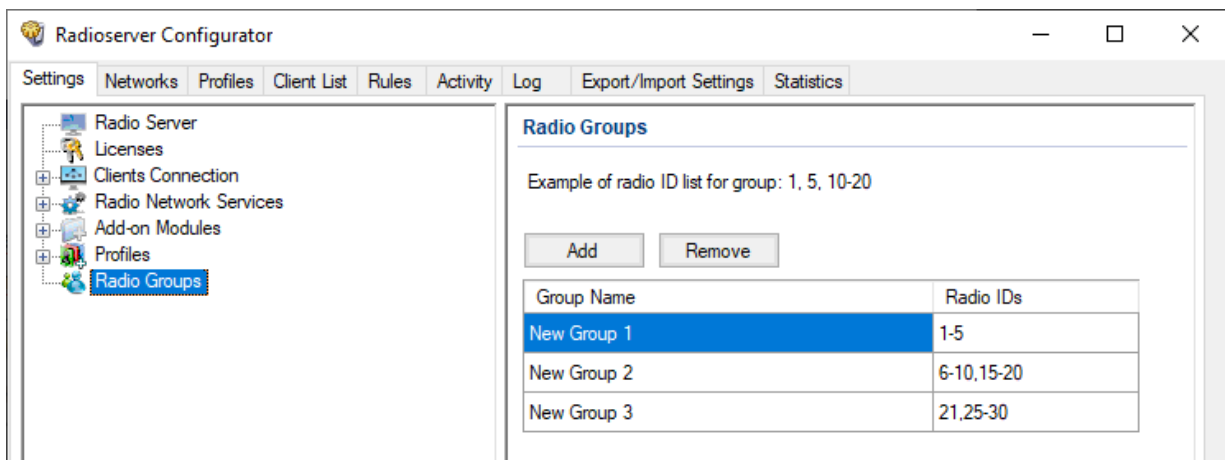

- Perform one of the following actions:

To add a new group,

click **Add**.



To modify a group, proceed to the next step.

To delete a group, perform the following actions:

1. Click the desired group.
2. Click **Remove**.
3. Proceed to [step 6](#).

-
4. In the desired table row, in the **Radio IDs** column, type the desired IDs. Use hyphens to enter radio ID ranges; use commas to list radio IDs and ID ranges.
 5. *(Optional)* In the desired table row, in the **Group Name** column, double-click the current group name, and then type the desired name.
 6. To save changes, at the bottom of the SmartPTT Radioserver Configurator window, click **Save Configuration** ().

Postrequisites:

To apply changes immediately, at the bottom of the SmartPTT Radioserver Configurator window, click **Start** () or **Restart** ().

4.4 Radios and Radio Users

The section describes information reception on radios presence and availability. Information includes the following aspects:

- Registration information provision over the DMR/MOTOTRBO protocol. For details, see [Registration of Radios](#).
- Registration information provision using option boards. For details, see [Registration with Option Boards](#).
- Information on the current radio user. For details, see [Radio Users](#).

4.4.1 Registration of Radios

Radios registration is a process of dispatchers' informing about the radio availability for voice and text transmissions, location requests, etc.

SmartPTT supports radio registration using the following mechanisms:

- Registration determined by the dedicated DMR/MOTOTRBO protocol. For details, see [Configuring ARS](#).
- On-activity radios registration (for example, when they initiate a call).

NOTE

On-activity registration is configured for each radio system connection and does **not** depend on the registration service activity in SmartPTT.

- Registration during the special messages (heartbeats) exchange between radioserver and radio with the properly programmed option boards. For details, see [Registration with Option Boards](#).
- Using the Radio Check command.

NOTE

Registration of radios in analog systems has the limited support. For details, submit a request to the [SmartPTT Technical Support Center](#).

Registration information access can be limited over the profile mechanism. If the service is turned off in the profile, all radios will appear “offline”.

4.4.1.1 MOTOTRBO Registration

In this section, information on registration information provision over the MOTOTRBO protocol is provided.

Data Provider

Registration information is provided from radios to the dispatch subsystem by different providers.

Radio System Access Type	Provider
Control stations (except analog interfaces)	Control station
Direct connection to IP Site Connect Hybrid connection to Capacity Plus	Repeaters
Network Application Interface (except Capacity Max)	Device Discovery and Mobility Service (DDMS)
Capacity Max	Presence Service in Capacity Max System Server
Connect Plus	Presence Notifier in XRC controllers

Recipient

Registration information is sent by a radio to another radio ID.

Radio System Access Type	Radio ID Assignee
Control stations (except analog interfaces)	Control station
Direct connection to IP Site Connect Hybrid connection to Capacity Plus	Radioserver
Network Application Interface (incl. Capacity Max)	MOTOTRBO Network Interface Service (MNIS)
Connect Plus	Radioserver

Registration Information Update

Registration information is updated in the following way:

- Radioserver sends up to 5 registration update requests to the radio network.

- Radio response timeout is equal to 30 seconds.
- For different radios, registration request interval is equal to 1 second.

4.4.1.2 Configuring ARS

Follow the procedure to activate and configure the radio registration service.

Procedure:

1. In SmartPTT Radioserver Configurator, open the **Settings** tab.
2. In the left pane, expand **Radio Network Services**, and then click **ARS**.
The registration service settings appear in the right pane.

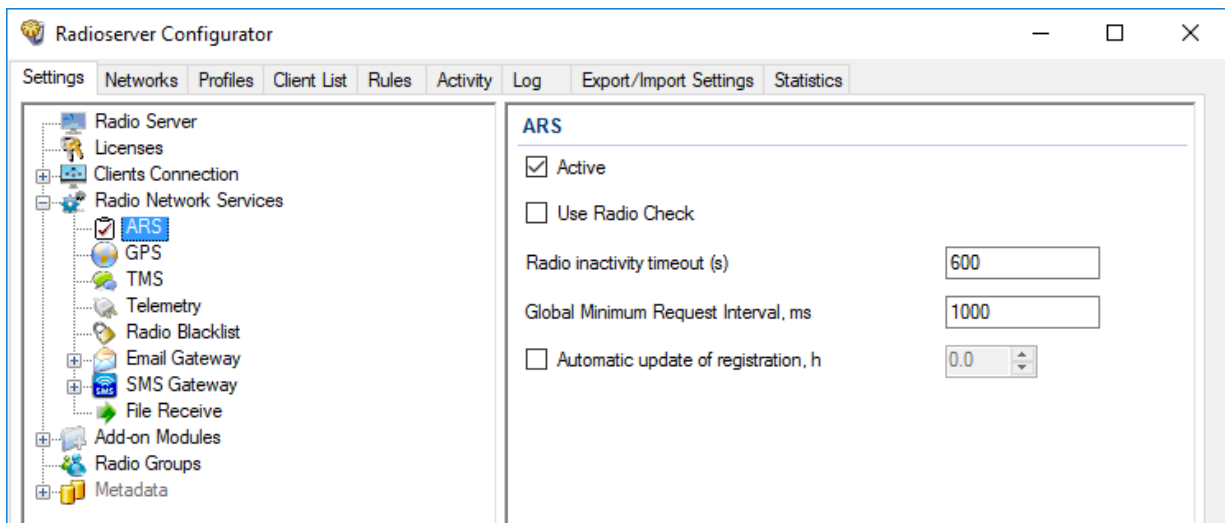



3. Select the **Active** check box.
4. If SmartPTT will be used in analog systems, select the **Use Radio Check** check box.
5. In the **Radio inactivity timeout (s)** field, type the radio inactivity timeout in seconds.

NOTE

If a radio does not transmit/respond to anything until the timeout expires, SmartPTT Radioserver will request its presence status update.

6. In the **Global Minimum Request Interval, ms** field, type the minimum time interval (in milliseconds) between sequential presence status requests from the radioserver.
7. (Optional) Configure the periodic presence status requests:
 - a. Select the **Automatic update of registration, h** check box.
 - b. In the unlocked field, enter the request sending period (in hours) that exceeds the radio inactivity timeout.
8. To save changes, at the bottom of the SmartPTT Radioserver Configurator window, click **Save Configuration** ().

Postrequisites:

To apply changes immediately, at the bottom of the SmartPTT Radioserver Configurator window, click **Start** () or **Restart** ().

4.4.2 Registration with Option Boards

SmartPTT supports registration of radios that have specifically programmed option boards. The feature is provided with the Sprite Configurator (Tallysman), and it is named Heartbeats.

Capabilities and Limitations

Registration messages are sent from radios to radioserver that must respond each message. With the response, it confirms its own presence in the radio network. If radioserver does not receive a message within the specific time, the radio will be considered turned off.

Using Sprite option boards for registration results in the following limitations:

- Radios cannot be used in the Connect Plus radio system that requires its own option boards.
- In radios, the Enhanced GNSS must be turned off.
- Location information storage and bundling will be unavailable.

Registration Configuration with Option Boards

To configure option boards to provide the radio presence information, the following actions must be performed:

- Option board must be re-programmed. For details, see [Programming GOB for Heartbeats](#).
- Configure Heartbeats in SmartPTT. For details, see [Configuring SmartPTT to Support Heartbeats](#).

4.4.2.1 Programming GOB for Heartbeats

Follow the procedure to view and/or modify MOTOTRBO™ option board settings required to support Heartbeats in SmartPTT.

Prerequisites:

Start Tallysman Sprite Configurator, and then ensure that its version is 0.2.68.

Procedure:

1. Open the option board codeplug.
2. In the left pane, expand **<Codeplug Internal Name>**, and then select **Heartbeat**. Heartbeat settings appear in the right pane.

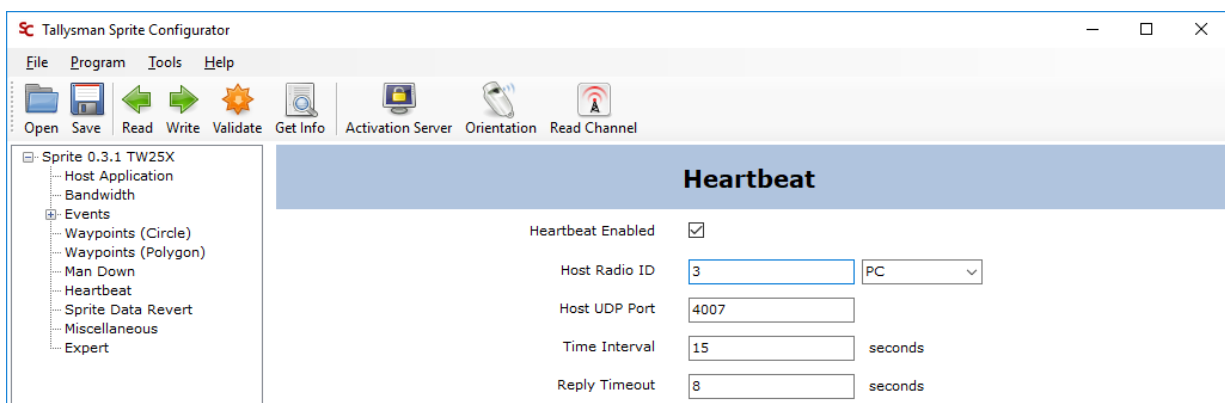

3. In the right pane, select the **Heartbeat Enabled** check box.
4. In the **Host Radio ID** field, type the system-specific SmartPTT Radioserver identifier.
5. From the list next to the **Host Radio ID** field, select *PC*.
6. In the **Host UDP Port** field, type the unlocked UDP port number of the computer with SmartPTT Radioserver.
7. In the **Time Interval** field, type the send period for radio heartbeat messages.
8. In the **Reply Timeout** field, type the maximum delay of the SmartPTT Radioserver response waiting after the heartbeat message is sent.
9. Save changes to the codeplug and write them to the option board.

4.4.2.2 Configuring SmartPTT to Support Heartbeats

Follow the procedure to configure the support of Heartbeats between the dispatch system and radios.

Prerequisites:

Using Tallysman Sprite Configurator, obtain the following parameters:

- Host UDP Port.
- Reply Timeout.

For details, see [Programming GOB for Heartbeats](#).

Procedure:

1. In SmartPTT Radioserver Configurator, open the **Settings** tab.
2. In the left pane, expand **Add-on Modules**, and then click **Tallysman**.

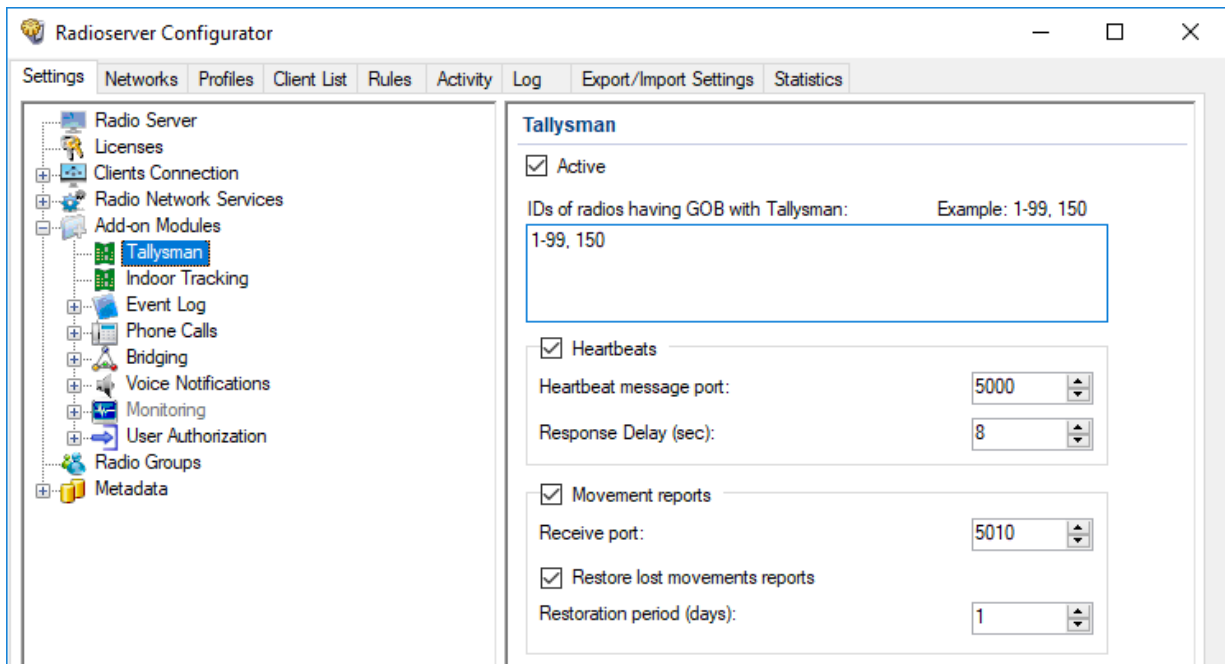

3. In the **Tallysman** pane, select the **Active** check box.
4. Select the **Heartbeats** check box.



5. In the **Heartbeat message port** field, enter the value of the **Host UDP Port** parameter set in Tallysman Sprite Configurator.
6. In the **Response Delay (sec)** field, enter the value of the **Reply Timeout** parameter set in Tallysman Sprite Configurator.

NOTE

You can enter the smaller value if needed.

7. To save changes, at the bottom of the SmartPTT Radioserver Configurator window, click **Save Configuration** ().

Postrequisites:

- To apply changes immediately, at the bottom of the SmartPTT Radioserver Configurator window, click **Start** () or **Restart** ().
- In the firewall software on the computer, unlock UDP port.

4.4.3 Radio Users

Radio users are represented with the unique ID that is sent from the radio to inform SmartPTT about the current user of the radio. The feature is available only for MOTOTRBO systems that use Device Discovery and Mobility Service (DDMS), or MOTOTRBO Capacity Max.

User Database Configuration

To configure the connection to the user database, the following actions must be performed:

- DBMS must be configured. For details, see [DBMS Configuration](#).
- Radioserver must be connected to DBMS. For details, see [Configuring User Database Connection](#).
- List of users must be configured. For details, see [Managing Radio Users](#).
- Database autobackup must be configured. For details, see [Configuring User Database Autobackup](#).

Aside from the actions above, the following changes in the MOTOTRBO infrastructure must be performed:

- The Sign In/Out feature must be turned on in radios.
- Dedicated MOTOTRBO interfaces must be configured:
 - For Capacity Max, system server settings must be changed.
 - For other systems, Device Discovery and Mobility Service must be re-configured.

4.4.3.1 Configuring User Database Connection

Follow the procedure to configure the user authorization service.

Prerequisites:

- Configure DBMS. For details, see [DBMS Configuration](#).
- Obtain the DBMS network address and process name.

- To use DBMS authorization, obtain the desired credentials. For details, see [Adding SQL Server Users](#).

Procedure:

- In SmartPTT Radioserver Configurator, open the **Settings** tab.
- In the left pane, expand the **Add-on Modules** node, and then click **User Authorization**.

The user authorization settings appear in the right pane.

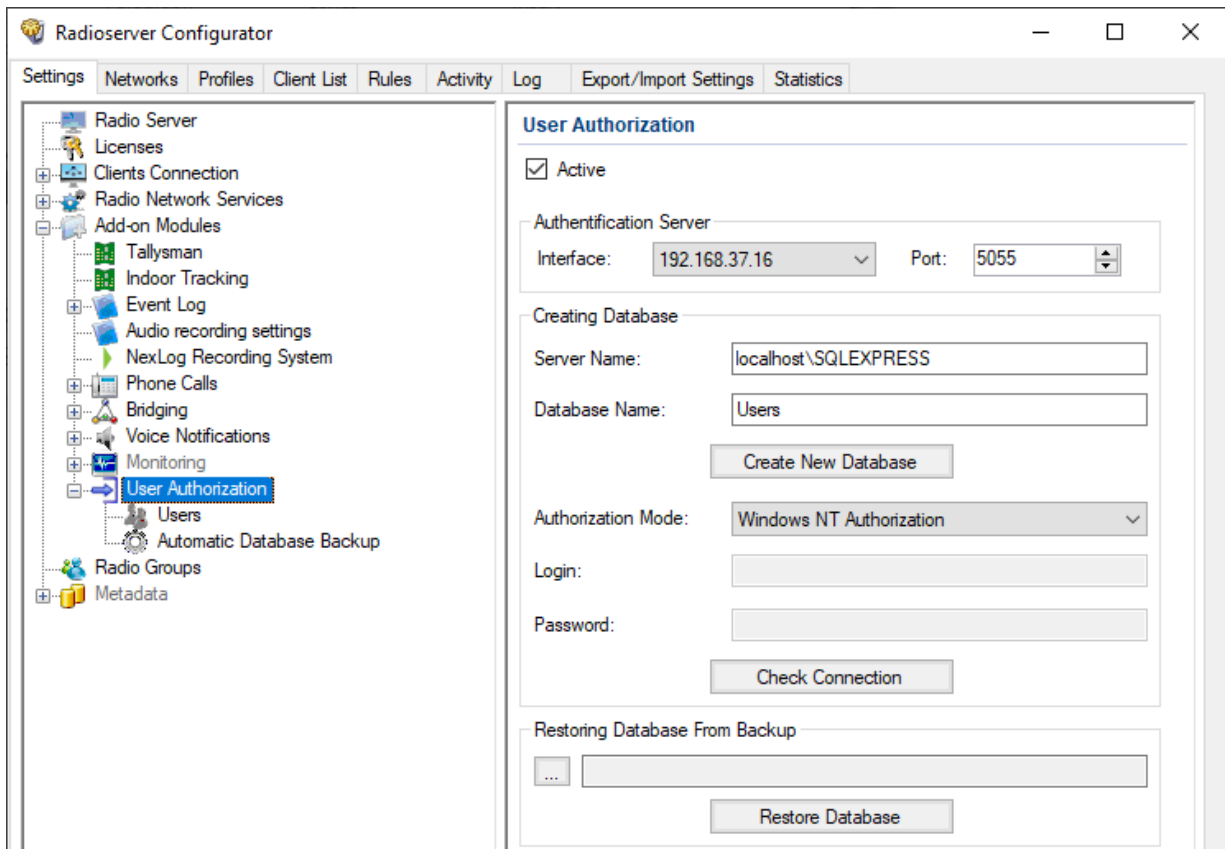

- Select the **Active** check box.
- From the **Interface** list, select the proper element:

To use any radioserver address for connection, select *Any*.

To use fixed radioserver IP address, select the desired address.

Important

If a radioserver and the MNIS service are installed on the same computer, use fixed address that is different from the MNIS IP address (default is *192.168.56.1*).

Important

If a radio or control station is connected to the radioserver host, use fixed address that is different from the radio or

control station address (default is *192.168.10.1*).

- In the **Port** field, enter the port number for authorization requests.

6. In the **Server Name** field, type the DBMS address in the following format:
<host name or IP address>\<DBMS service name>.
7. In the **Database Name** field, type the DBMS process name.
8. Configure authorization in the DBMS:

To use Windows authorization,

from the **Authorization Mode** list, select *Windows NT Authorization*.



To use DBMS authorization,

perform the following actions:

1. From the **Authorization Mode** list, select *SQL Server Authorization*.
 2. In the **Login** field, type the login of the desired SQL Server account.
 3. In the **Password** field, type the password of the desired SQL Server account.
-

9. Click **Create New Database** to create a database with the specified parameters.
A success or error message appears.
10. (Optional) Click **Check Connection** to check the connection with SQL Server and access to the database.
A success or error message appears.
11. To save changes, at the bottom of the SmartPTT Radioserver Configurator window, click **Save Configuration** ().

Postrequisites:

- Add radio users. For details, see [Managing Radio Users](#).
- Configure database auto backup. For details, see [Configuring User Database Autobackup](#).
- To apply changes immediately, at the bottom of the SmartPTT Radioserver Configurator window, click **Start** () or **Restart** ().

4.4.3.2 Managing Radio Users

Follow the procedure to add, edit, or delete the radio user entry.

Prerequisites:

- Determine user IDs.
- Configure the user database connection. For details, see [Configuring User Database Connection](#).

Procedure:

1. In SmartPTT Radioserver Configurator, open the **Settings** tab.

- In the left pane, expand **Add-on Modules** → **User Authorization**, and then click **Users**.

List of users appears in the right pane.

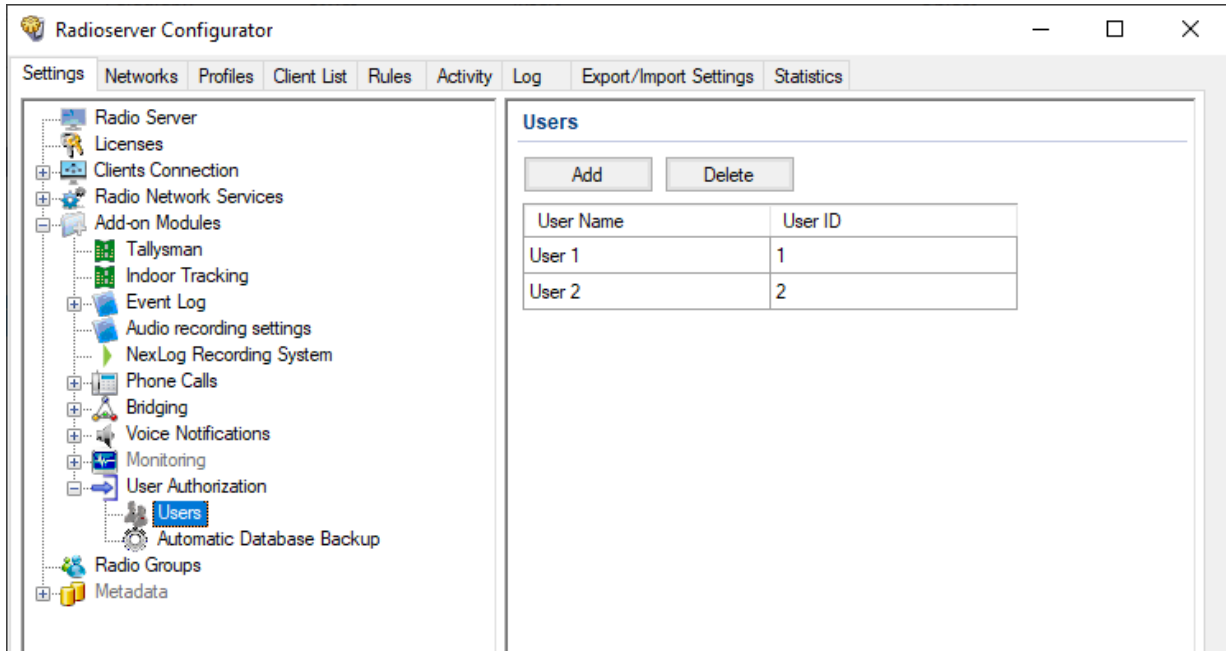

- Perform one of the following actions:

To add a new user,

click **Add**.

To modify a user's name and/or ID,

proceed to the next step of the procedure.

To delete a user,

perform the following actions:

- Click the desired user entry.
- Click **Delete**.
- Proceed to [step 6](#).



- In the desired table row, in the **User ID** column, double-click the current ID, and then type the desired ID.

Important

Do not confuse User ID and Radio ID.

- (Optional)* In the same row, in the **User Name** column, double-click the current user name, and then type the desired name.
- To save changes, at the bottom of the SmartPTT Radioserver Configurator window, click **Save Configuration** ().

Postrequisites:

To apply changes immediately, at the bottom of the SmartPTT Radioserver Configurator window, click **Start** () or **Restart** ().

4.4.3.3 Configuring User Database Autobackup

Follow the procedure to configure the automatic database backup.

Prerequisites:

- Add radio users. For details, see [Configuring User Database Connection](#).
- Determine the backup storage.
- Create the backup creation schedule.

Procedure:

1. In SmartPTT Radioserver Configurator, open the **Settings** tab.
2. In the left pane, expand **Add-on Modules** → **User Authorization**, and then click **Automatic Database Backup**.

The backup settings appear in the right pane.

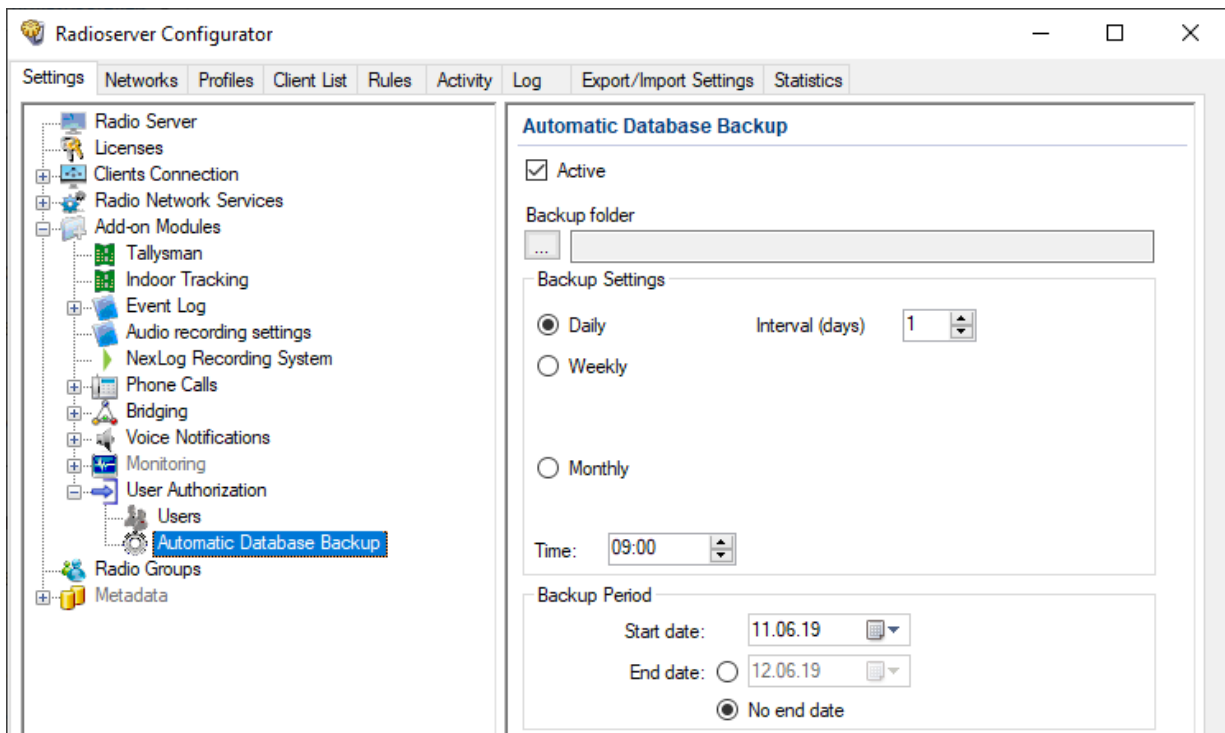

3. Select the **Active** check box.
4. Specify the folder for backups:
 - a. Click the Browse () button to the left of the **Backup folder** field. The dialog box appears.
 - b. In the dialog box, select the desired directory and click **OK**.
5. In the **Backup Settings** area, configure the periodic backup:

To create backups once in a few days,

perform the following actions:

1. Click **Daily**.

2. In the **Interval (days)** field, enter the number of days between backups (1 means daily backups).

To create backups on specific days of week with the specific time period,

perform the following actions:

1. Click **Weekly**.
2. Select check boxes that are related to the days of week when the backup must be created.
3. In the **Interval (weeks)** field, enter the number of weeks between backups (1 means weekly backups).

To create backups on specific days of month,

perform the following actions:

1. Click **Monthly**.
2. In the **Day of month** field, enter the day of the month when the backup must be created.
3. In the **Interval (month)** field, enter the number of months between backups (1 means monthly backups).

6. In the **Time** field, enter the time when the backup process starts.
7. (*Optional*) In the **Backup Period** area, configure start and end dates of the time interval when the backups must be created:
 - a. In the **Start date** field, enter the start date of the backup creation.
 - b. Configure the end date of the time interval:

To unset the end date,

click **No end date**.



To specify the end date,

perform the following actions:

1. Click **End date**.
2. In the unlocked field, enter the end date.

8. To save changes, at the bottom of the SmartPTT Radioserver Configurator window, click **Save Configuration** ().

Postrequisites:

To apply changes immediately, at the bottom of the SmartPTT Radioserver Configurator window, click **Start** () or **Restart** ().

4.5 Location

SmartPTT supports radios that are able to report their location in the various location systems. Those systems are as follows:

- Satellite systems that are widespread for global geographical location determination (radio latitude and longitude).
- Beacon systems that are widespread for indoor and/or local location determination. For details, see [Location with Option Boards](#).

Interaction with satellite systems can be organized in the following ways:

- Data exchange over the MOTOTRBO protocol. For details, see [Location in Radio Systems](#).
- Data exchange using the dedicated protocol provided by option boards. For details, see [Location with Option Boards](#).

Important

Location using satellites is supported only for MOTOTRBO radios.

To determine radio location, special location data protocols are used. The default data protocol for sending location reports is set in radio codeplug for each channel individually. SmartPTT supports the following protocols:

- LRRP
- LIP

LRRP (Location Request & Response Protocol)

LRRP — Motorola proprietary protocol for sending requests and receiving reports on radio location.

Location reports are provided as responses. The following types of requests are supported:

- Radioserver requests that require radio groups. For details, see [Configuring GPS](#).
- Dispatch console requests with per-radio request conditions. For details, see “Radio Location Properties” in *SmartPTT Dispatcher Guide*.

LIP (Location Information Protocol)

LIP — DMR-standardized protocol for receiving reports on radio location.

Radios provide coordinates according to settings configured in their codeplugs (with time interval, with distance interval, on emergency). If a radio uses LIP to transmit location data on the current channel, SmartPTT can request coordinates from the radio using LRRP.

Important

To receive reports on radio location over LIP, SmartPTT Radioserver use 5017 as the default port number. If you have any problems connected with the need to redefine the port number, submit a request to [SmartPTT Technical Support Center](#).

Location Report Recipient

Each MOTOTRBO radio (with and without an option board) provides its location report to the specific ID. The ID is selected from the pool of Radio IDs.

As radio systems work together with SmartPTT, ID selection is affected with the following limitations:

- If radioserver receives location reports over a control station, all radios must report their location to the Radio ID of the control station.
- If radioserver receives location reports at the direct connection to IP Site Connect or hybrid connection to Capacity Plus, radios must report their location to the Radio ID of the radioserver in the corresponding radio system.
- If radioserver receives location reports over the Network Application Interface (NAI) or it is connected to Capacity Max, radios must report their location to the Radio ID assigned to the MNIS service.

Important

Dispatcher IDs must never be used as recipient IDs of the location reports.

4.5.1 Location in Radio Systems

SmartPTT supports location requests and provides location reports/responses to SmartPTT Dispatcher applications. SmartPTT Dispatcher uses location reports for the following purposes:

- Shows the current radio location on maps.
- Tracks radios using routes, geofences, and points of interest.

Also, location reports could be used for rules configuration. For details, see “Positioning Rules” in *SmartPTT Dispatcher Guide*.

Location Update Rate

In MOTOTRBO, the location update rate is determined with the following factors:

- Radio system interface (control station, direct IP connection, or NAI).
- CSBK data support.
- Window size.

As a result, the following results could be achieved:

Minimum Update Interval	Maximum Update Rate	Window Size
7.5 s	8 times per minute	1 or 2
15 s	4 times per minute	5
30 s	2 times per minute	6
60 s	1 time per minute	7

Minimum Update Interval	Maximum Update Rate	Window Size
120 s	30 times per hour	8
240 s	15 times per hour	9
480 s	7–8 times per hour	10

Radio Channel Capacity

Maximum number of location reports that could be provided over the radio channel is determined by the following factors:

- Radio system interface (control station, direct IP connection, NAI).
- CSBK data support.
- Window size.
- Voice/data ratio configured on the repeater slot.

Depending on them, the following results could be achieved:

Window Size	Number of location reports per minute			
	90%	75%	60%	45%
1	904	752	600	456
2	448	376	304	224
5	180	150	120	90
6	150	125	100	75
7	128	107	86	64
8	112	93	75	56
9	100	83	66	50
10	90	75	60	45

In the table, percentage is related to the repeater slot allocation for data retransmission.

Important

All the numbers in the table are the maximum values. Real slot capacity is lower because of the radio signal attenuation, radio frequency interference, on-site surface complexity, etc.

4.5.1.1 Configuring GPS

Follow the procedure to activate and configure GPS location service.

Prerequisites:

Add radio groups. For details, see [Managing Radio Groups](#).

Procedure:

1. In SmartPTT Radioserver Configurator, open the **Settings** tab.
2. In the left pane, expand **Radio Network Services**, and then click **GPS**.
The satellite location settings appear in the right pane.

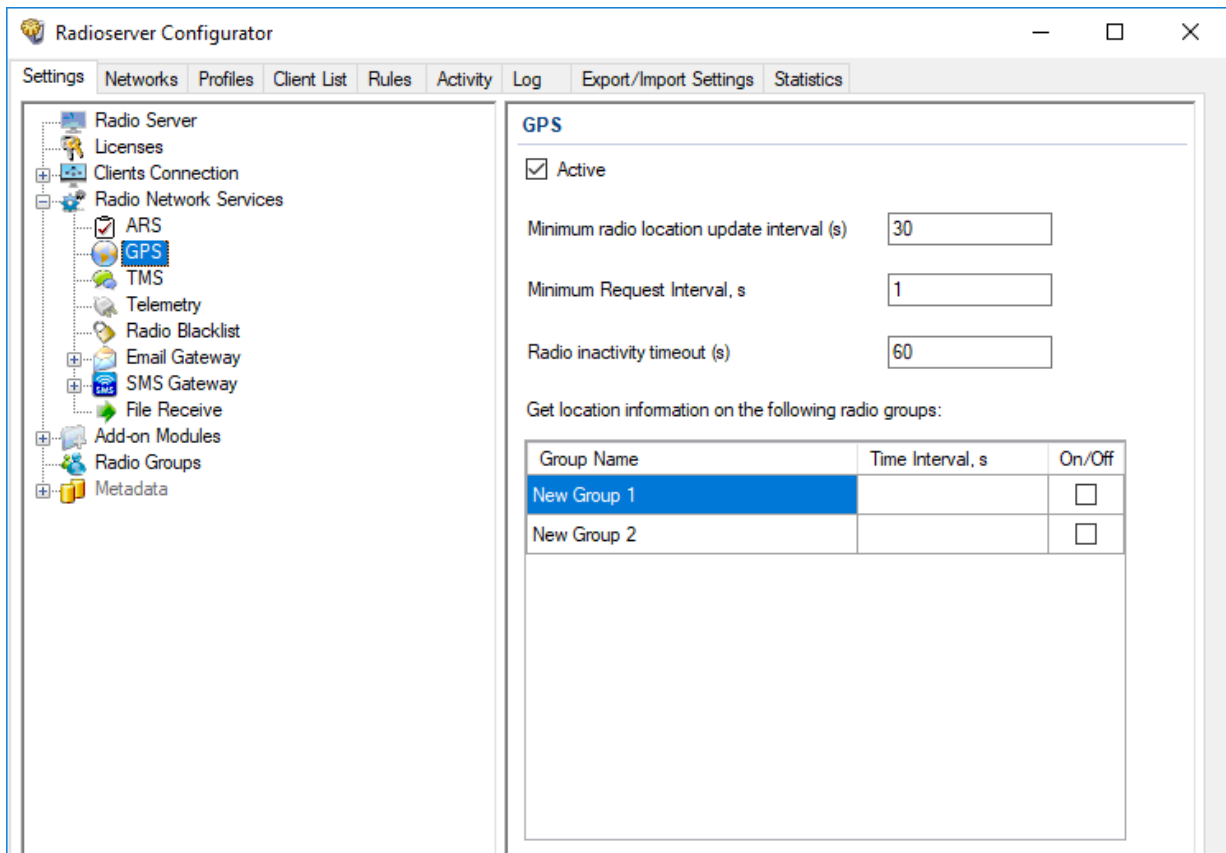

3. Select the **Active** check box.
4. In the **Minimum radio location update interval (s)** field, type the minimum radio location update time interval (in seconds) that can be set by the dispatcher.
5. In the **Minimum Request Interval, s** field, type the minimum time interval (in seconds) between location requests to any radio.
6. In the **Radio inactivity timeout (s)** field, type the time interval (in seconds) after which a radio that did not send GPS location is considered as potentially inactive to send location update request.
7. To configure automatic GPS update irrespective of whether SmartPTT Dispatcher is available or not, in the table below, perform the following actions:
 - a. Select the **On/Off** check box for the desired radio groups.

- b. In the **Time Interval, s** column, type the desired time interval (in seconds) for GPS request.

NOTE

With an active SmartPTT Dispatcher, GPS requests will be updated at the same time accordingly to the radio group settings and accordingly to the individual settings specified in SmartPTT Dispatcher.

8. To save changes, at the bottom of the SmartPTT Radioserver Configurator window, click **Save Configuration** ().

Postrequisites:

To apply changes immediately, at the bottom of the SmartPTT Radioserver Configurator window, click **Start** (▶) or **Restart** ().

4.5.2 Location with Option Boards

SmartPTT supports radios that use option boards for satellite navigation. In particular, it supports option boards programmed with the Tallysman Sprite Configurator.

Capabilities and Limitations

Boards programmed with Tallysman Sprite Configurator provide the following features to SmartPTT:

- High rate of location updates (up to 6 times per minute).
- Location reports storing when the radio is out of the RF coverage zone (up to 12 times per minute).
- Great reports storage interval (up to 30 days).

When the radio returns to the RF coverage zone, it starts sending stored reports to SmartPTT. With this, SmartPTT provides the following features:

- Provides reports to active dispatch consoles in real time.
- Dispatch consoles update radio tracks and log location reports in its database.

Using option boards for satellite location results in the following limitations:

- APEX-compliant radios do not support option board installation and use.
- Radios cannot be used in the Connect Plus radio systems due to the dedicated option boards utilization.
- Location reports cannot be provided over the revert channel of the radio system.
- Location reports cannot be provided over control stations that are accessible over RG-1000e.
- Radios cannot operate in the Enhanced GNSS mode.

Location Configuration

To configure radio location using option boards, the following actions must be performed:

- Option board must be programmed with the Tallysman Sprite Configurator. For details, see [Configuring Location Storage in GOB](#).
- *(Optional)* Revert mode needs to be configured. For details, see [Configuring GOB Reverting](#).

- Option board reports must be supported in SmartPTT. For details, see [Configuring GOB Reports Reception](#).

4.5.2.1 Configuring Location Storage in GOB

Follow the procedure to view and/or modify option board settings required to support location reports storage and their provision to SmartPTT.

Prerequisites:

- Determine the proper target ID for location reports:
 - If control stations are used, from the station codeplug, obtain its Radio ID.
 - If direct connection to IP Site Connect is used, use the radioserver ID on the corresponding slot. For details, see [Configuring Slots](#).
 - If hybrid connection to Capacity Plus is used, use the radioserver ID in the radio system. For details, see “Control Station” in the SmartPTT Radioserver Configurator embedded help.
 - If NAI is used to access a radio system, or radioserver connects to Capacity Max, use the MNIS Application ID. For details, see “MNIS Application ID” in the MNIS Configuration Utility embedded help.
- Determine if a control station or IP Site Connect slot is used as a data channel:
 - For information on control station parameters, see [Adding and Editing MOTOTRBO Control Stations](#).
 - For information on the IP Site Connect slot parameters (direct connection), see [Configuring Slots](#).
 - For information on the IP Site Connect slot parameters (NAI), see [Configuring SmartPTT Identification](#).
- Start the Tallysman Sprite Configurator, and then ensure that its version is 0.3.16.

Procedure:

- Open the option board codeplug.
- In the left pane, expand the **<Codeplug Internal Name>**, and then click **Host Application**. Host settings appear in the right pane.

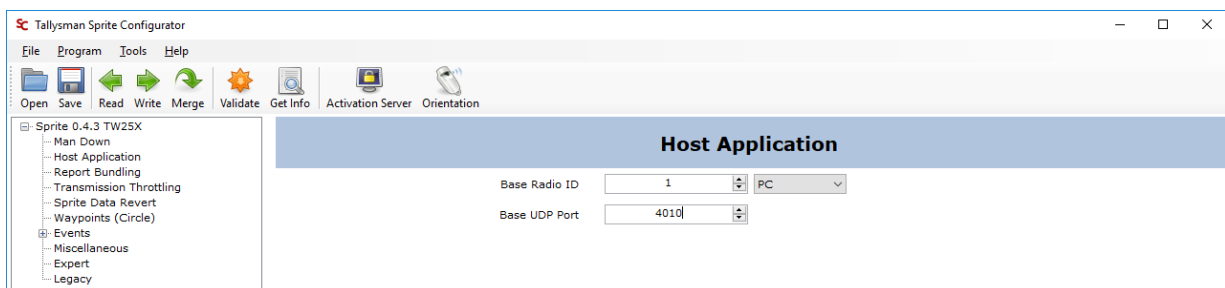

- In the right pane, enter the SmartPTT Radioserver identification information:
 - In the **Base Radio ID** field, enter radioserver ID in the relevant radio system.
 - From the list that appears next to field, select *PC*.
 - In the **Base UDP Port** field, set the radioserver UDP port used to receive location reports.

NOTE

If default value is applicable, leave the parameter unchanged.

4. In the left pane, click **Report Bundling**.
Report settings appear.

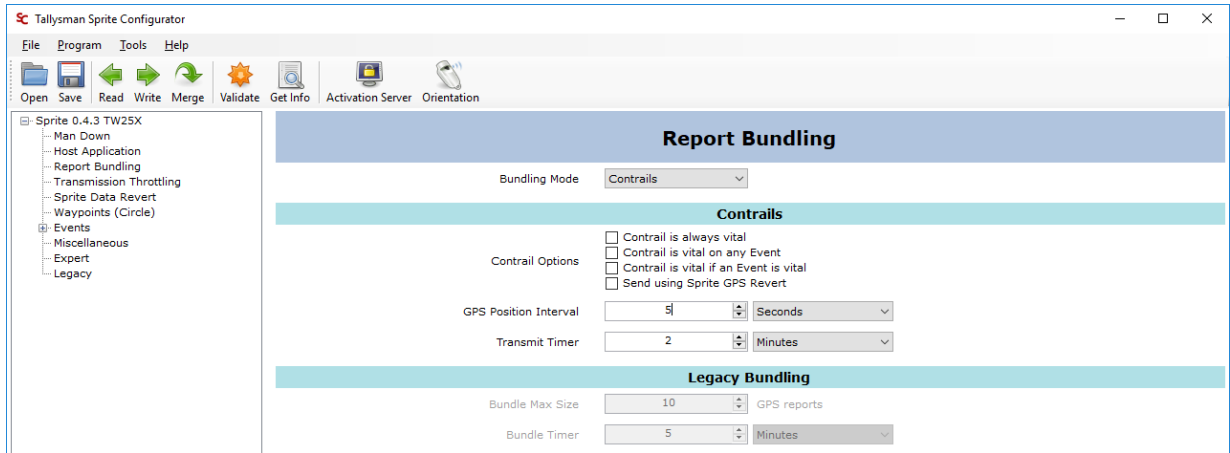

5. In the right pane, from the **Bundling Mode** list, select *Contrails*.
6. Clear the following check boxes:
 - Contrail is always vital
 - Contrail is vital on any Event
 - Contrail is vital if an Event is vital
7. Configure the location report delivery mode:

To send reports over the fixed slot,

configure reverting. For details, see [Configuring GOB Reverting](#).

To send reports over the slot that provided the location request,

clear the **Send using Sprite GPS Revert** check box.

8. Configure the location request interval:
 - a. From the list next to the **GPS Position Interval** field, select the desired measurement units.
 - b. In the **GPS Position Interval** field, set the desired period of time. The recommended value is 10 s.
9. Configure the location transmission attempt interval:
 - a. From the list next to the **Transmit Timer** field, select the desired measurement units.
 - b. In the **Transmit Timer** field, set the desired period of time. The recommended value is 2 s.
10. In the left pane, expand **Events**.
11. For each subnode of the **Events** node, perform the following actions:
 - a. Click the subnode.
 - b. In the right pane, clear the **Event Enabled** check box.
12. Save changes to the codeplug and write them to the option board.

4.5.2.2 Configuring GOB Reverting

Follow the procedure to configure the location data sending over the fixed channel configured in the radio. This option is available only in IP Site Connect radio systems.

Important

In radio system, the required channel must **not** be used as data revert channel. Sending location reports over the revert channels is not supported.

Prerequisites:

- Turn off the Enhanced GNSS mode for time slot of the repeater that is placed in the same site as the radio. If the slot is system-wide, turn off Enhanced GNSS in all repeaters of the system.
- From the radio codeplug, obtain the Zone ID and Channel ID for the corresponding slot.
- In radio codeplugs, turn off the Data Revert mode.
- Start the Tallysman Sprite Configurator, and then ensure that its version is 0.3.16.

Procedure:

1. Open the option board codeplug.
2. In the left pane, expand the **<Codeplug Internal Name>**, and then click **Report Bundling**. Revert settings appear in the right pane.

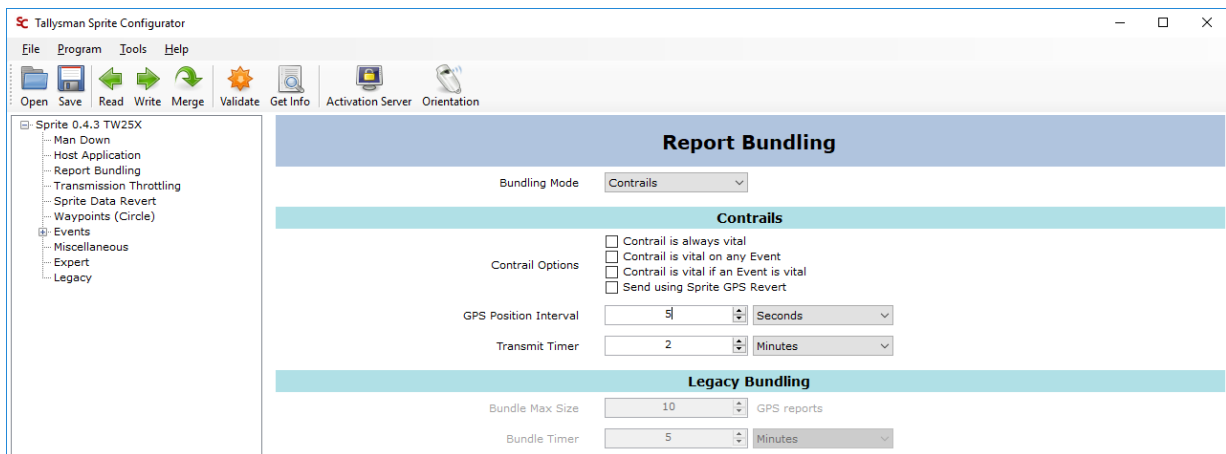

3. In the right pane, in the Contrails area, select the **Send using Sprite GPS Revert** check box or ensure that it is selected.
4. In the left pane, click **Sprite Data Revert**.
Revert mode settings appear in the right pane.

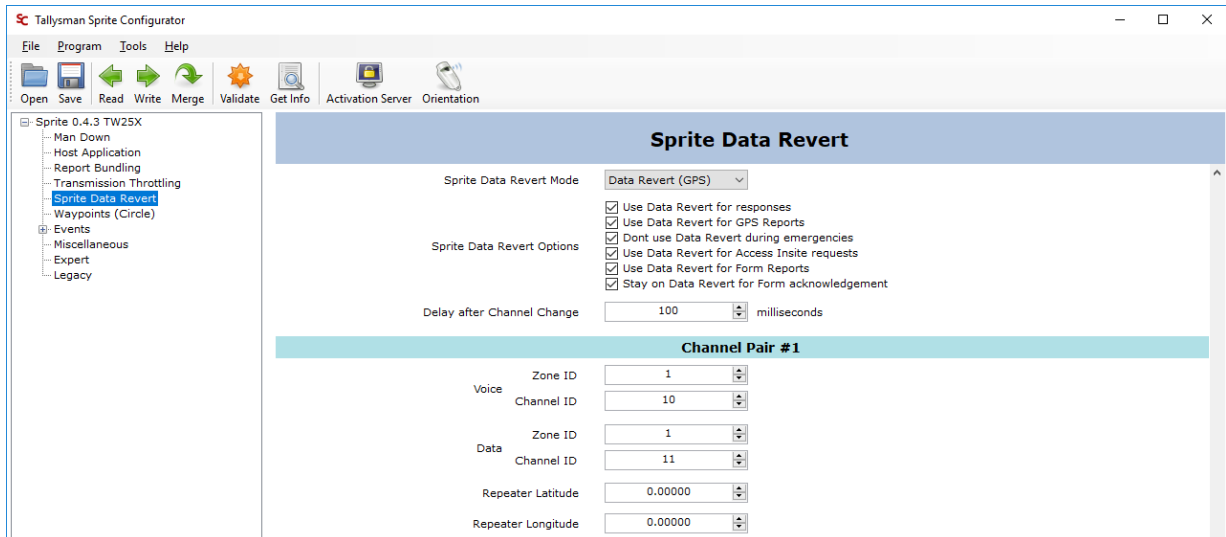

5. In the right pane, from the **Sprite Data Revert Mode** list, select *Data Revert (GPS)*.
6. To the right of the **Sprite Data Revert Options** heading, select all check boxes.
7. (Optional) In the **Delay after Channel Change** field, set the delay (in milliseconds) between the data channel selection and location data sending.
8. In the **Channel Pair #1** area, perform the following actions:
 - a. To the right of the **Data** heading, in the **Zone ID** field, enter the zone ID where the target channel belongs.
 - b. To the right of the **Data** heading, in the **Channel ID** field, enter the ID of the channel that will be used for location reports sending.
9. In the same area, in all other fields, enter 0.
10. Enter 0 in all fields of all of the following areas (from **Channel Pair #2** to **Channel Pair #8**).
11. Save changes to the codeplug and then write them to the option board.

Postrequisites:

- Configure other option boards in the same way.
- In the corresponding slot settings, activate the Data Channel mode:
 - For information on slot parameters at the direct connection, see [Configuring Slots](#).
 - For information on slot parameters at the NAI connection, see [Configuring SmartPTT Identification](#).

4.5.2.3 Configuring GOB Reports Reception

Follow the procedure to configure movement reports restoration in SmartPTT.

Prerequisites:

- Obtain Radio IDs of radios that have option boards configured for the feature.
- Using Tallysman Sprite Configurator, obtain the target UDP port (related to the **Base UDP Port** parameter). For details, see [Configuring Location Storage in GOB](#).
- Determine the necessity of the restoration period limitation and determine the limiting value.

Procedure:

1. In SmartPTT Radioserver Configurator, open the **Settings** tab.
2. In the left pane, expand **Add-on Modules**, and then select **Tallysman**.

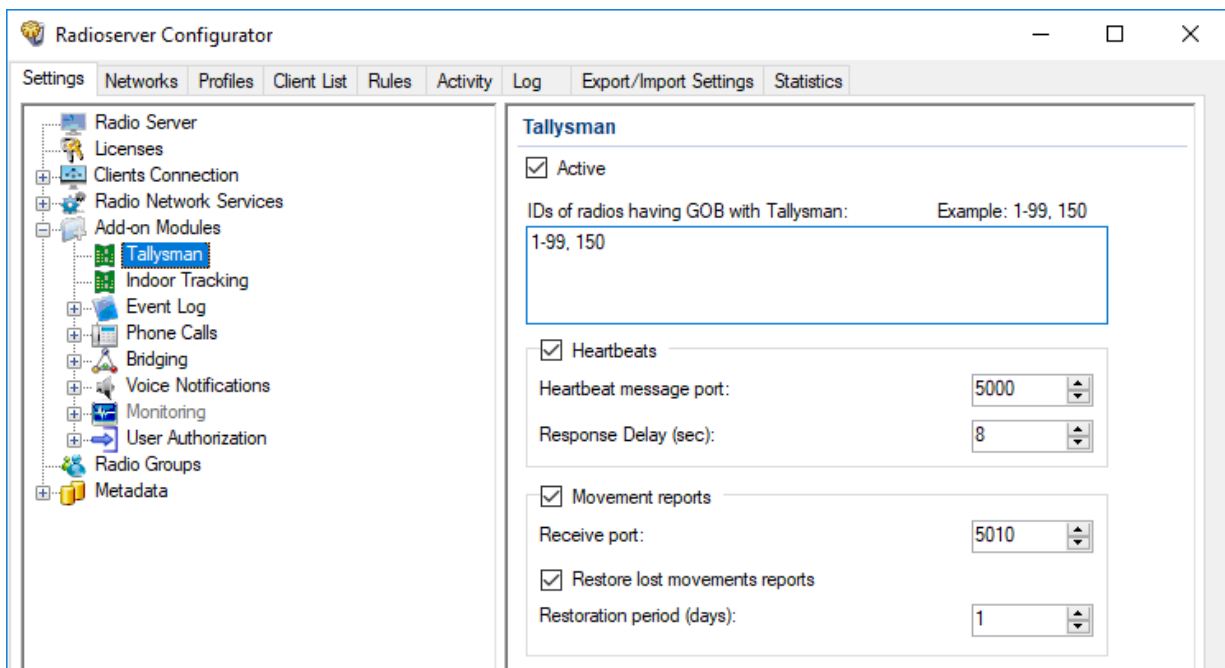



3. In the right pane, select the **Active** check box.
4. In the **IDs of radios having GOB with Tallysman** field, type radio IDs of subscriber units with properly configured option boards. Use hyphens to enter radio ID ranges; use commas to list radio IDs and ID ranges.
5. Select the **Movement reports** check box.
6. In the **Receive port** field, set the value of the **Base UDP Port** parameter from the Tallysman Sprite Configurator.
7. To limit the restoration period, perform the following actions:
 - a. Select the **Restore lost movements reports** check box.
 - b. In the **Restoration period (days)** field, set the restoration period in days.

NOTE

The day unit here is equal to 24 hours. If you type 3, SmartPTT Radioserver requests coordinates collected on the GOB within the last 72 hours.

- To save changes, at the bottom of the SmartPTT Radioserver Configurator window, click **Save Configuration** ().

Postrequisites:

- To apply changes immediately, at the bottom of the SmartPTT Radioserver Configurator window, click **Start** () or **Restart** ().
- In the firewall software on the computer, unlock the specified UDP port.

4.5.3 Beacon-Based (Indoor) Location

SmartPTT supports radios that report their location using radio beacon signals. Such systems operate in the following way:

- Radio receives signals from one or multiple nearby radio beacons which location is known.
- Radio sends IDs of beacons that were recognized to SmartPTT.
- SmartPTT receives beacon IDs and determines the radio location in the point that is equidistant from the beacons.

Important

SmartPTT does **not** support the radio location determination based on the signal strength or other methods due to their unreliability.

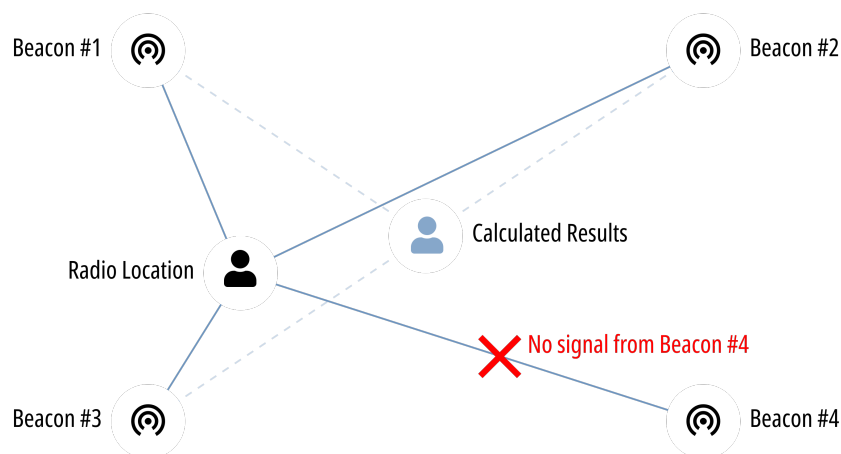
**NOTE**

Beacon-based location systems may also be referred to as “Indoor Location Services”.

SmartPTT supports the following beacon-based technologies:

- iBeacon. For details, see [iBeacons Technology](#).
- BluFi Wireless. For details, see [BluFi and Kilchherr](#).
- Kilchherr Elektronik AG. For details, see [BluFi and Kilchherr](#).

Location reports are sent to the radioserver ID that is determined in one of the following ways:

- If radioserver uses control stations to receive reports, on-site radios must send reports to the Radio ID of the control station.
- If radioserver connects directly to the IP Site Connect or connects to the Capacity Plus using hybrid interface, radios must send reports to the Radio ID of the radioserver on the corresponding slot of the system.
- If radioserver uses NAI for the radio system connection or connects to Capacity Max, radios must send reports to the MNIS Application ID.

4.5.3.1 iBeacons Technology

iBeacon technology is based on the Bluetooth capabilities. It requires radios to have the built-in Bluetooth module. With it, radio accesses the following features:

- Beacon-based location in Connect Plus.
- Using option boards for various purposes:
 - Radios registration. For details, see [Registration with Option Boards](#).
 - Location using satellite systems. For details, see [Location with Option Boards](#).

Important

In Connect Plus, radios must send location reports to the radioserver ID.

iBeacon Configuration

To configure the iBeacon location technology, the following actions must be performed:

- Ensure that the radio has the built-in Bluetooth module.
- In the radio, install the license that unlocks indoor services.
- In the radio codeplug, turn on the following services:
 - Location services
 - Indoor location services
 - Bluetooth
- Add a list of beacons to the radio codeplug.

Important

All of the information above provides the minimum required modification of the radio codeplug. It is **not** related to the complete radio configuration. If you need assistance in the MOTOTRBO devices configuration, contact Motorola Solutions representatives in your region.

4.5.3.2 BluFi and Kilchherr

Reports provision using BluFi technology and Kilchherr technology differs from the iBeacon technology. They are based on the dedicated option boards. Using boards results in the following limitations:

- They are **not** applicable in Connect Plus.
- They are incompatible with Heartbeats (radio registration over option boards). For details, see [Registration with Option Boards](#).
- They are incompatible with the location reports storage. For details, see [Location with Option Boards](#).

BluFi

To configure radios to use the BluFi technology, the following actions must be performed:

- Option board must be configured as instructed by BluFi. For information on compatible option boards, see [Third Party Products](#).
- Text messages must be turned on in radioserver. For details, see [Configuring Beacons in SmartPTT](#).

Kilchherr

To configure radios to use the Kilchherr technology, compatible option boards must be configured as instructed by vendors. For information on compatible option boards, see [Third Party Products](#).

4.5.3.3 Configuring Beacons in SmartPTT

Follow the procedure to support beacon-based location in SmartPTT.

Prerequisites:

- Configure radio devices to support the desired beacon-based location.
- If BluFi is used, activate text message service in SmartPTT. For details, see [Activating TMS and Telemetry](#).
- Ensure that the SmartPTT license allows Indoor services. For details, see [Viewing License Items](#).

Procedure:

1. In SmartPTT Radioserver Configurator, open the **Settings** tab.
2. In the left pane, expand **Add-on Modules**, and then click **Indoor Tracking**.
The beacon-based location settings appear in the right pane.

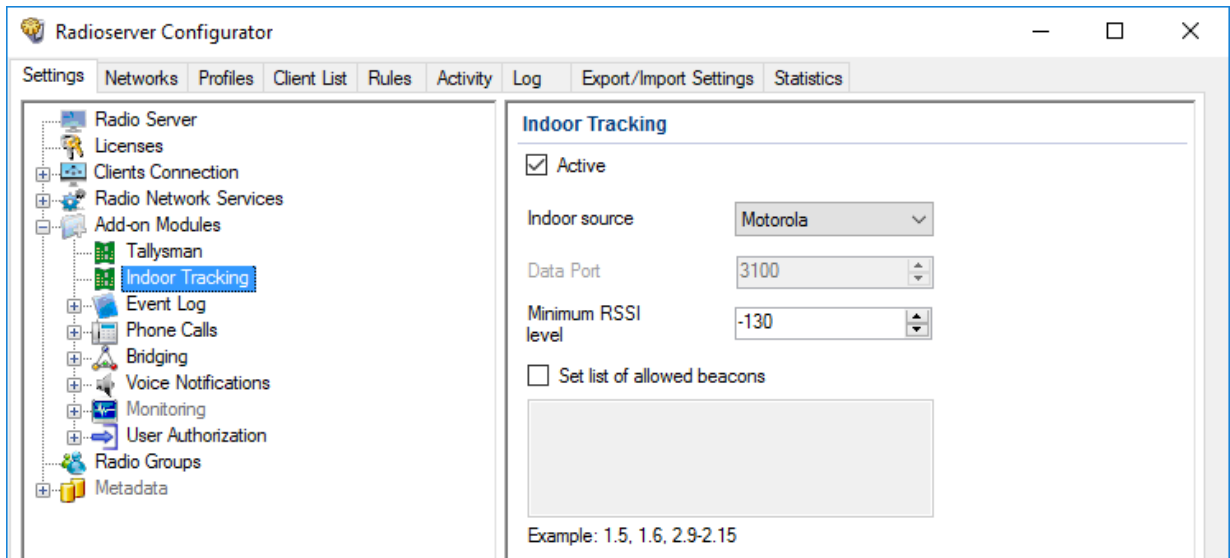

3. In the right pane, select the **Active** check box.
4. Configure the desired technology:

To use iBeacon,

perform the following actions:

1. From the **Indoor source** list, select *Motorola*.
2. In the **Minimum RSSI level** field, enter the lowermost reliable signal strength level.

To use BluFi Wireless,

from the **Indoor source** list, select *BluFi*.

To use Kilchherr,

perform the following actions:

1. From the **Indoor source** list, select *Kilchherr*.
2. In the **Data Port** field, enter the radioserver port number.

5. (Optional) Configure beacons:

To receive signals from any beacon,

clear the **Set list of allowed beacons** check box.

To receive signals from the limited set of iBeacons,

perform the following actions:

1. Select the **Set list of allowed beacons** check box.

2. In the unlocked field, type beacon IDs in the following format: *<group number>.<beacon number in the group>*. Use hyphens to enter ranges; use commas to list IDs and ID ranges.

To receive signals from the limited set of BluFi/Kilchherr beacons,

perform the following actions:



1. Select the **Set list of allowed beacons** check box.
2. In the unlocked field, type beacon IDs. Use hyphens to enter ranges; use commas to list IDs and ID ranges.

NOTE

List of configured iBeacons must correlate with the list of beacons configured in radio codeplugs.

6. To save changes, at the bottom of the SmartPTT Radioserver Configurator window, click **Save Configuration** ().

Postrequisites:

To apply changes immediately, at the bottom of the SmartPTT Radioserver Configurator window, click **Start** () or **Restart** ().

4.5.4 Complex Location Reports

If the radio location is simultaneously tracked with satellite and beacon location systems, radio channel bandwidth can be insufficient for data transmission. As a result, several reports and/or beacon signals could be lost. This results in the invalid radio location.

To optimize the location update, the following actions are recommended to be performed:

- Radio codeplugs must be modified in the following way:
 - Enhanced GNSS must be turned on for the used slots.
 - Configure Windows Size to be equal to *10*.
 - Turn on the compressed UDP headings.
 - Select the compression format to be equal to *MSI*.
- In repeater codeplugs, Enhanced GNSS must be turned on for repeater slots.
- In SmartPTT Dispatcher, indoor location update interval must be configured to be equal to 30 seconds.

4.6 Activating TMS and Telemetry

Follow the procedure to activate various SmartPTT services that do **not** require additional configuration.

Procedure:

1. In SmartPTT Radioserver Configurator, open the **Settings** tab.
2. In the left pane, expand **Radio Network Services**.
3. Configure one or multiple services:

To activate text message service,

perform the following actions:

1. Click the **TMS** node.
2. Select the **Active** check box.



To activate telemetry service,

perform the following actions:

1. Click the **Telemetry** node.
2. Select the **Active** check box.

-
4. To save changes, at the bottom of the SmartPTT Radioserver Configurator window, click **Save Configuration** ().

Postrequisites:

To apply changes immediately, at the bottom of the SmartPTT Radioserver Configurator window, click **Start** () or **Restart** ().

4.7 Logging

SmartPTT logs information about events that occur during its operation. The following software components are able to log information:

- Radioserver.
- Each individual dispatch console.

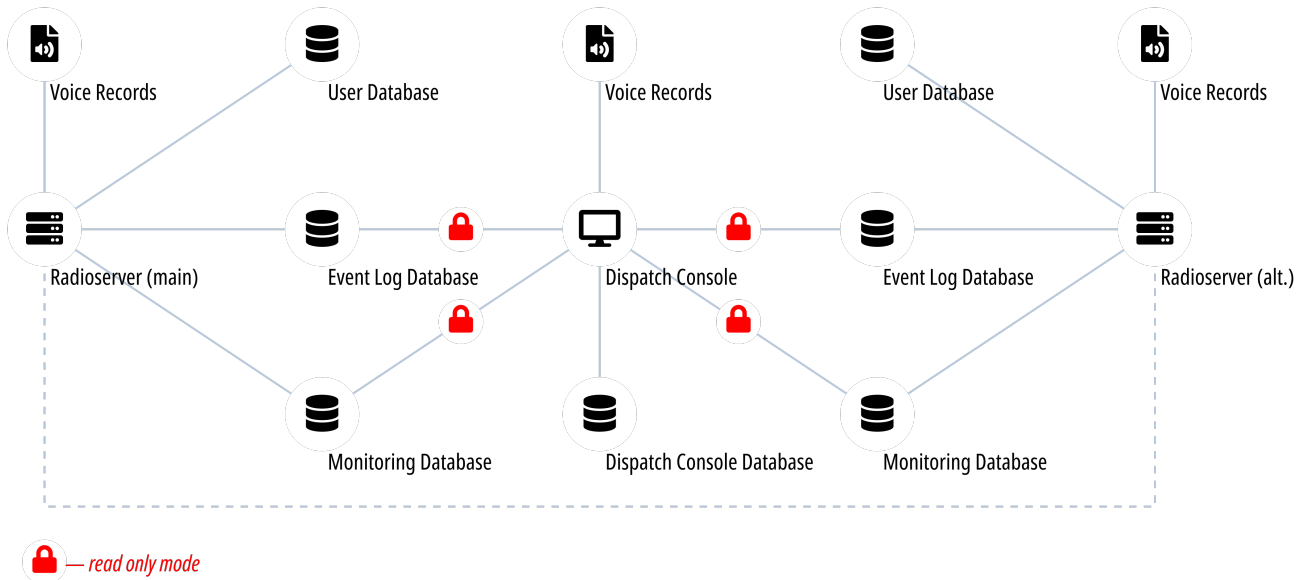

The following information is related to the radioserver logging. For information on the dispatch console logging, see the following sections:

- For events information, see “Event Log” in *SmartPTT Dispatcher Guide*.
- For voice records information, see “Records” in *SmartPTT Dispatcher Guide*.

DBMS Utilization

SmartPTT uses database management system to store event records. Voice records are stored outside DBMS. For details, see [Voice Recording](#).

SmartPTT supports Microsoft SQL Server only. For information on the supported DBMS versions, see [Third Party Products](#).

DBMS access and authorization are managed by various services. They can be implemented in one of the following ways:

Authorization Type	Applicability
Windows local authorization	Radioserver and DBMS are installed on the same computer.
Windows active directory (domain) authorization	Radioserver and DBMS are installed on the same computer. <ul style="list-style-type: none"> • Radioserver and DBMS are installed on different computers that belong to the same active directory. • Radioserver and DBMS are running on behalf of the same active directory user.
DBMS-controlled authorization	DBMS is configured to authenticate users.

4.7.1 Event Log Database

Event log database in radioserver stores the following events information:

- Voice calls (group and private calls).
- Emergency alarms and calls.
- Voice-equivalent transmissions (voice notifications, audio files data).
- Radio registration reports.
- Radio location reports.
- Radio commands and their responses.
- Telemetry and remote control commands.
- SmartPTT SCADA alarms.

Database must be activated and configured to provide the following SmartPTT features:

- Radioserver rules. For details, see [Rules](#).
- Viewing radioserver-logged events and listening to radioserver-logged voice records in SmartPTT Dispatcher. For details, see “Database” in *SmartPTT Dispatcher Guide*.
- Creating reports in SmartPTT Dispatcher. For details, see “Reports” in *SmartPTT Dispatcher Guide*.

Important

Radioserver database (not DBMS) must **not** be used by SmartPTT Dispatcher to log events information.

Event Log Database Configuration

To configure the event log database, the following actions must be performed:

- Database management system must be configured. For details, see [DBMS Configuration](#).
- Radioserver must be connected to the database. For details, see [Configuring Event Log Database Connection](#).
- Database retention policy must be configured. For details, see [Configuring Event Log Database Retention Policy](#).
- Database automatic backup must be configured. For details, see [Configuring Event Log Automatic Backup](#).

4.7.1.1 Configuring Event Log Database Connection

Follow the procedure to configure the event log database connection.

Prerequisites:

- Obtain IP address/domain name of the DBMS host.
- Obtain DBMS process name.
- If DBMS-controlled authorization is used, obtain the corresponding credentials. For details, see [Adding SQL Server Users](#).

Procedure:

1. In SmartPTT Radioserver Configurator, open the **Settings** tab.
2. In the left pane, expand the **Add-on Modules** node, and then click **Event Log**.
The event log settings appear in the right pane.

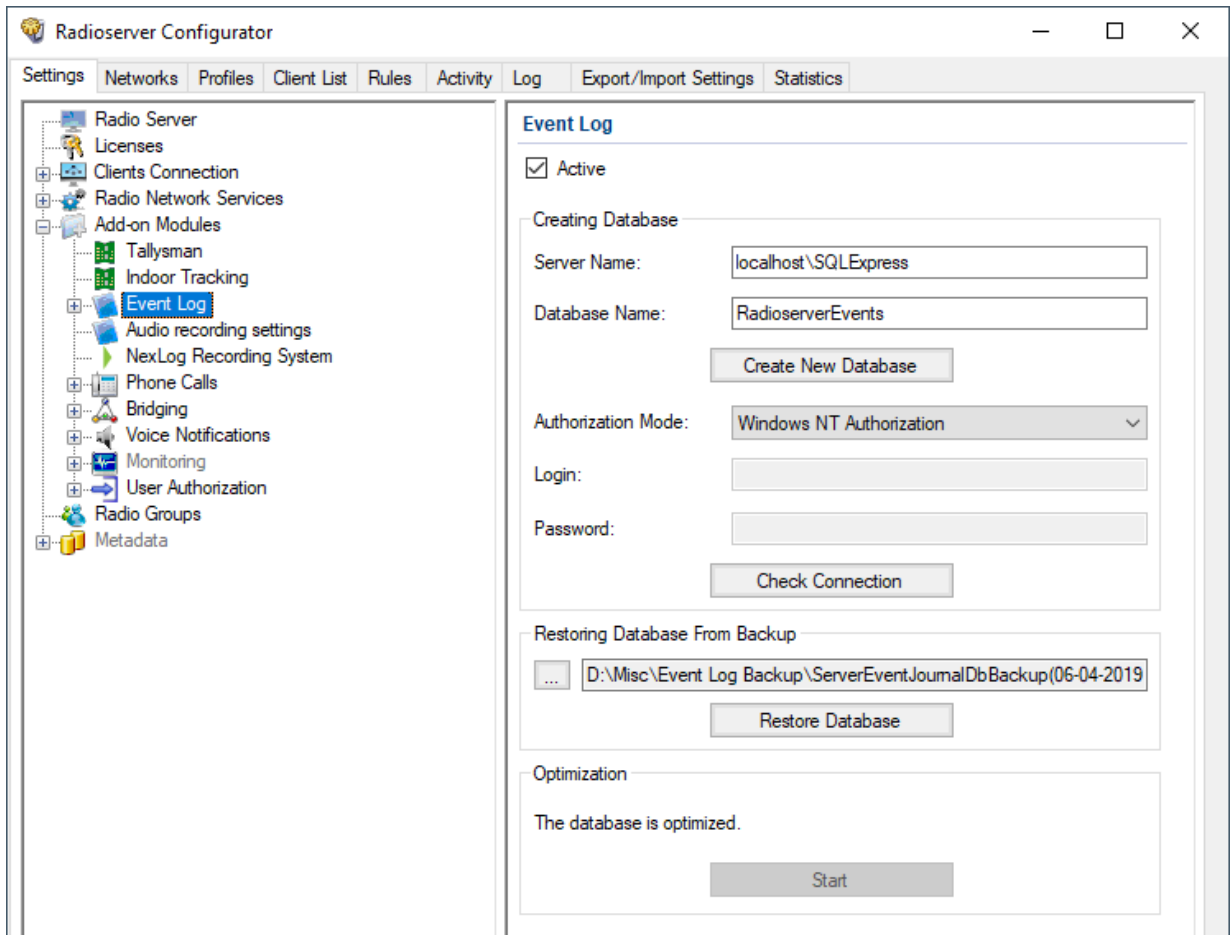

3. Select the **Active** check box.
4. In the **Server Name** field, type the DBMS address in the following format:
<IP Address or Host Name>\<Process Name>.
5. In the **Database Name** field, type the database name.
6. Configure authorization:

To use Windows authorization,

from the **Authorization Mode** list, select *Windows NT Authorization*.



To use DBMS authorization,

perform the following actions:

1. From the **Authorization Mode** list, select *SQL Server Authorization*.
2. In the **Login** field, type user login.
3. In the **Password** field, type the user password.

7. Click **Create New Database** to create a database with the specified parameters.
A success or error message appears.
8. (Optional) Click **Check Connection** to check the connection with SQL Server and access to the database.
A success or error message appears.
9. To save changes, at the bottom of the SmartPTT Radioserver Configurator window, click **Save Configuration** ().

Postrequisites:

- Configure database retention policy. For details, see [Configuring Event Log Database Retention Policy](#).
- Configure database automatic backup. For details, see [Configuring Event Log Automatic Backup](#).
- To apply changes immediately, at the bottom of the SmartPTT Radioserver Configurator window, click **Start** () or **Restart** ().

4.7.1.2 Configuring Event Log Database Retention Policy

Follow the procedure to configure the database retention policy. This helps to avoid database overflow and save the disk space.

Prerequisites:

Configure the event log database connection. For details, see [Configuring Event Log Database Connection](#).

Procedure:

1. In SmartPTT Radioserver Configurator, open the **Settings** tab.
2. In the left pane, expand **Add-on Modules** → **Event Log**, and then click **Settings**.
The event retention settings appear in the right pane.

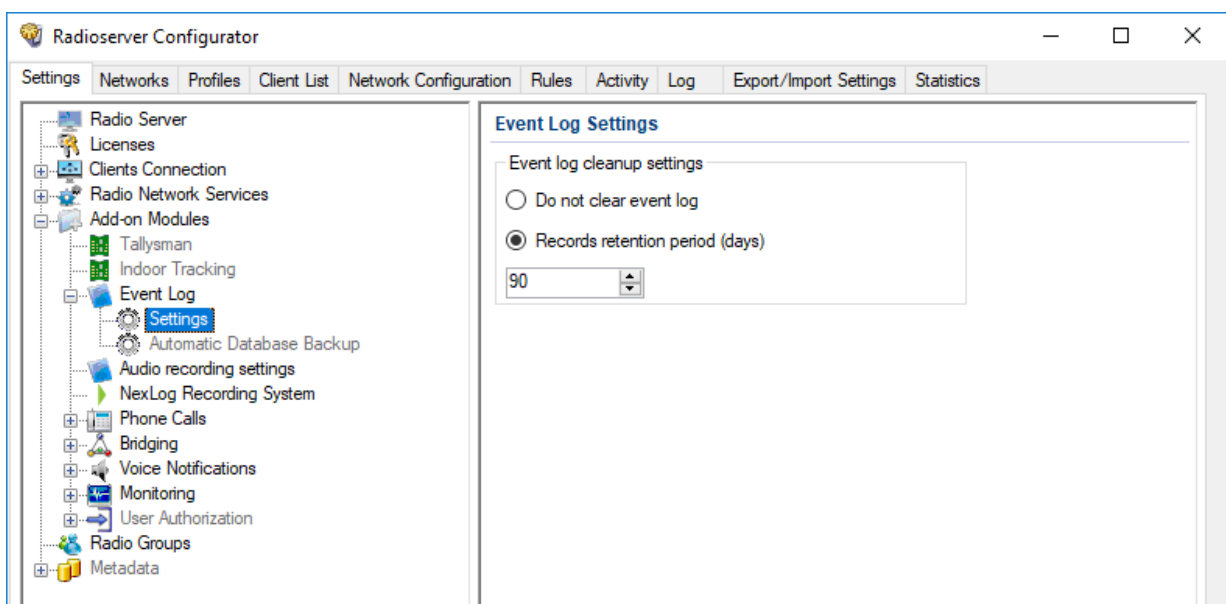

3. In the right pane, perform one of the following actions:

To prevent log entries deletion from the database,

click **Do not clear event log**.

To delete outdated event entries,

perform the following actions:



1. Click **Records retention period (days)**.
2. In the unlocked field, enter the retention period duration (in days).

NOTE

If you enter 0, database will store only the current day events.

-
4. To save changes, at the bottom of the SmartPTT Radioserver Configurator window, click **Save Configuration** ().

Postrequisites:

To apply changes immediately, at the bottom of the SmartPTT Radioserver Configurator window, click **Start** () or **Restart** ().

4.7.1.3 Configuring Event Log Database Autobackup

Follow the procedure to configure the event log database automatic backup.

Prerequisites:

- Configure the event log database connection. For details, see [Configuring Event Log Database Connection](#).
- Determine the backup storage.
- Create the backup creation schedule.

Procedure:

1. In SmartPTT Radioserver Configurator, open the **Settings** tab.

- In the left pane, expand **Add-on Modules** → **Event Log**, and then click **Automatic Database Backup**. The database backup settings appear in the right pane.

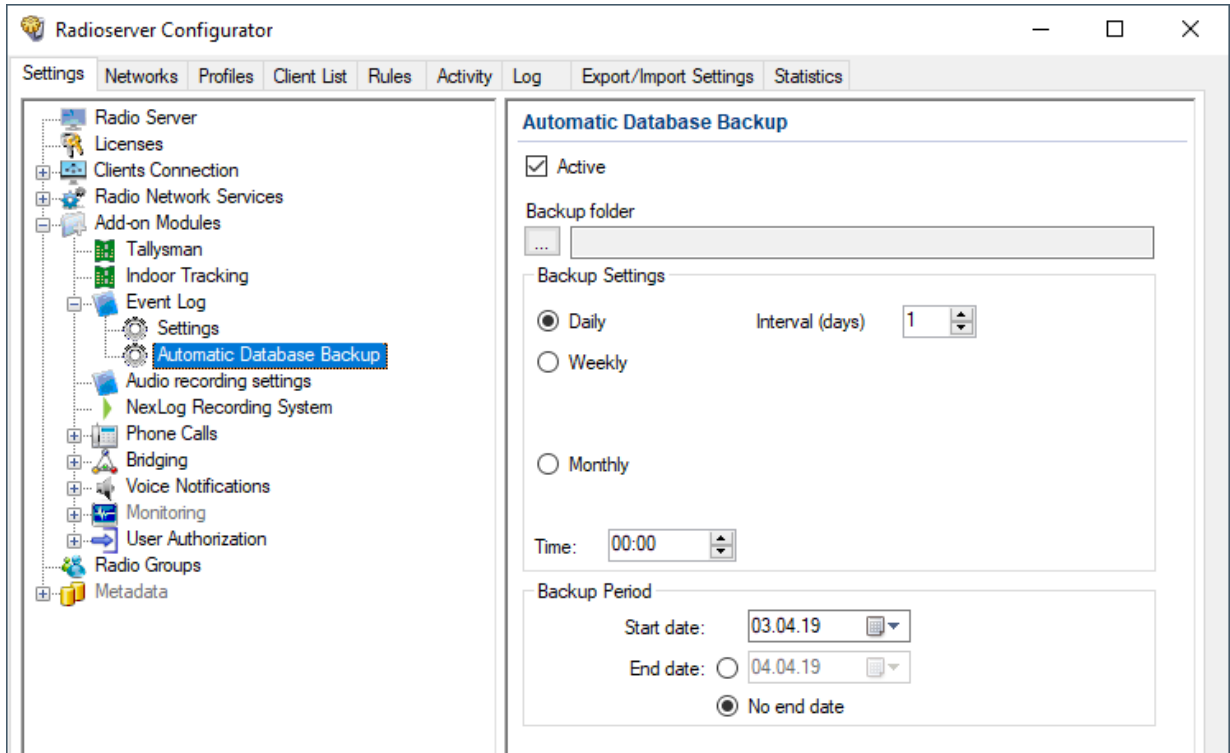

- Select the **Active** check box.
- Determine the backup storage directory:
 - Click the Browse () button to the left of the **Backup folder** field. Browse dialog box appears.
 - In the dialog box, specify the directory, and then click **OK**.
- In the **Backup Settings** area, configure the backup period:

To create backups once in several days,

perform the following actions:

- Click **Daily**.
- In the **Interval (days)** field, enter the number of days between backups (1 means daily backups).

To create backups on specific days of week with the specific time period,

perform the following actions:

- Click **Weekly**.
- Select check boxes that are related to the days of week when the backup must be created.
- In the **Interval (weeks)** field, enter the number of weeks between backups (1 means weekly backups).

To create backups once in several months,

perform the following actions:

1. Click **Monthly**.
2. In the **Day of month** field, enter the day of month when the database backup starts.
3. In the **Interval (month)** field, enter the number of months between backups (*1* means monthly backups).

6. In the **Time** field, enter the time of the day when the database backup creation starts.

7. (*Optional*) In the **Backup Period** area, configure start and end dates of the time interval when the backups must be created:

- a. In the **Start date** field, enter the start date of the backup creation.
- b. Configure the end date of the time interval:

To unset the end date,

click **No end date**.



To specify the end date,

perform the following actions:

1. Click **End date**.
2. In the unlocked field, enter the end date.

8. To save changes, at the bottom of the SmartPTT Radioserver Configurator window, click **Save Configuration** ().

Postrequisites:

To apply changes immediately, at the bottom of the SmartPTT Radioserver Configurator window, click **Start** () or **Restart** ().

4.7.2 Voice Recording

SmartPTT supports voice records between radios and dispatchers. The following components may perform voice logging:

- SmartPTT radioserver.
- Each dispatch console.

All of the following information is related to the radioserver voice recording. For information on voice recording in dispatch consoles, see “Records” in *SmartPTT Dispatcher Guide*.

In addition to SmartPTT, the following products are also able to record voice calls:

- NexLog Recording Systems that received voice streams from radioserver in real time. For details, see [Configuring NexLog Connection](#).
- RG-1000e radio gateways that provide 2-wire interface for analog voice loggers. For details, see “Recorder” in *CPS RG-1000e User Guide*.

Also, SmartPTT API allows users to create their own voice loggers.

Recorded Call Types

SmartPTT radioserver records the following call types:

- Group calls.
- Private calls.
- All Calls.

It also logs the following voice-equivalent transmissions:

- Voice notifications.
- Audio files (configured using rules and deferred actions).

Radioserver does **not** record the following call types:

- Voice calls initiated from the phone numbers or addressed to the phone numbers (include private and group calls).
- Voice calls between dispatchers (Console Intercom).

Also, radioserver does **not** include service tones in audio files (grant tone, override tone, etc.).

Call Recording Conditions

To record voice calls, the following conditions must be fulfilled:

- Call initiator and/or recipient must be included in the allowed radio ID list on the radioserver.
- Call initiator and/or recipient is a dispatcher or radioserver.

SmartPTT does **not** require configuring talkgroups and All Calls to record group calls.

Records Storage

During the calls recording, SmartPTT may operate in two modes:

- Record calls in audio files in the pre-defined local/network directory.
- Send voice streams to the NexLog digital recorder in real time. For details, visit the [NexLog Recording Systems](#) webpage.

Both modes could be used simultaneously.

Important

Radioserver record storage must be different from the dispatch console record storage due to the different retention periods.

Audio files content complies with the following requirements:

Call Type	Audio File Content
Group call	One or several voice transmissions to the same talkgroup with or without a hangtime between them. Voice recording continues until the hangtime expires and the channel/slot is free.
Private call	One or several voice transmissions between radios. One or several voice transmissions between a radio and uniquely identified dispatcher. One or several voice transmissions between radio and dispatchers that do not have their own IDs (if a call is initiated to the radioserver ID).
All Call	Single voice transmission from initiator.

4.7.2.1 Configuring Centralized Voice Logging

Follow the procedure to configure centralized (radioserver controlled) call recording.

Prerequisites:

- Prepare call recording directory.
- Ensure that the SmartPTT license allows voice call recording. For details, see [Viewing License Items](#).

Procedure:

1. In SmartPTT Radioserver Configurator, open the **Settings** tab.
2. In the left pane, expand the **Add-on Modules** node, and then click **Audio recording settings**. The audio recording settings appear in the right pane.

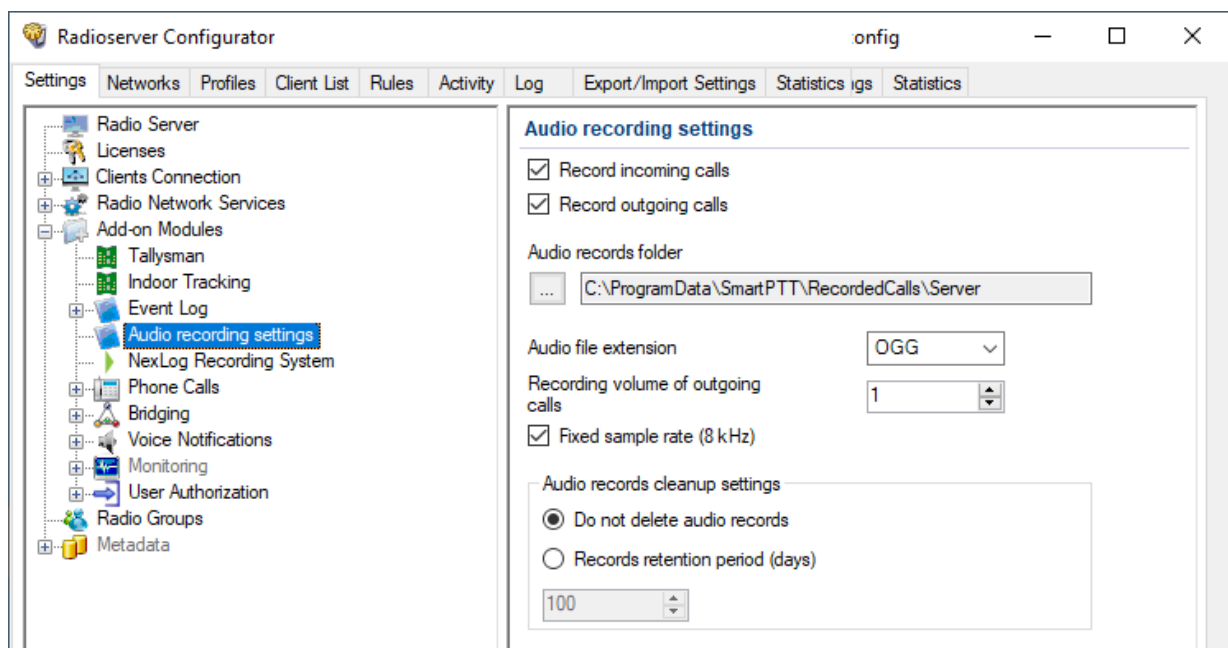

3. Configure the recorded call types:

To record voice calls from radio networks, select the **Record incoming calls** check box.

To record voice calls from dispatchers, select the **Record outgoing calls** check box.

4. Specify the directory where radioserver records will be stored:

- a. Click the Browse () button to the left of the **Audio records folder** field. The dialog box appears.
- b. In the dialog box, select the desired directory, and then click **OK**.

5. From the **Audio file extension** list, select the desired audio format:

To save records in the MP3 format, select *MP3*.

To save records in the OGG format, select *OGG*.

To save records in the WAV (uncompressed) format, select *WAV*.

6. In the **Recording volume of outgoing calls** field, enter the desired volume gain index for outgoing calls (initiated by dispatchers). To not change the recording volume, enter *1*.

7. (*Optional*) To fix the audio sampling rate at 8 kHz, select the **Fixed sample rate (8 kHz)** check box.

8. In the **Audio records cleanup settings** area, configure audio records retention policy:

To prevent audio files from deletion by a radioserver, click **Do not delete audio records**.

To delete outdated audio files, perform the following actions:



1. Click **Records retention period (days)**.
2. In the unlocked field, enter the retention period (in days).

NOTE

If you enter *0*, only the current day records will be stored.

9. To save changes, at the bottom of the SmartPTT Radioserver Configurator window, click **Save Configuration** ().

Postrequisites:

To apply changes immediately, at the bottom of the SmartPTT Radioserver Configurator window, click **Start** () or **Restart** ().

4.7.2.2 Configuring NexLog Connection

Follow the procedure to configure SmartPTT connection to the NexLog recorder.

Prerequisites:

- From the NexLog settings, obtain the following data:
 - Recorder IP address.
 - Range of RTP/UDP ports allocated for SmartPTT.
 - Vocoder type.
- If a radioserver and NexLog are connected over the router with the active Network Address Translation service, obtain router IP address and port range that will be transmitted to those of the recorder.
- Ensure that the SmartPTT license allows the NexLog connection. For details, see [Viewing License Items](#).

Procedure:

- In SmartPTT Radioserver Configurator, open the **Settings** tab.
- In the left pane, expand **Add-on Modules**, and then click **NexLog Recording System**.
The recorder connection settings appear in the right pane.

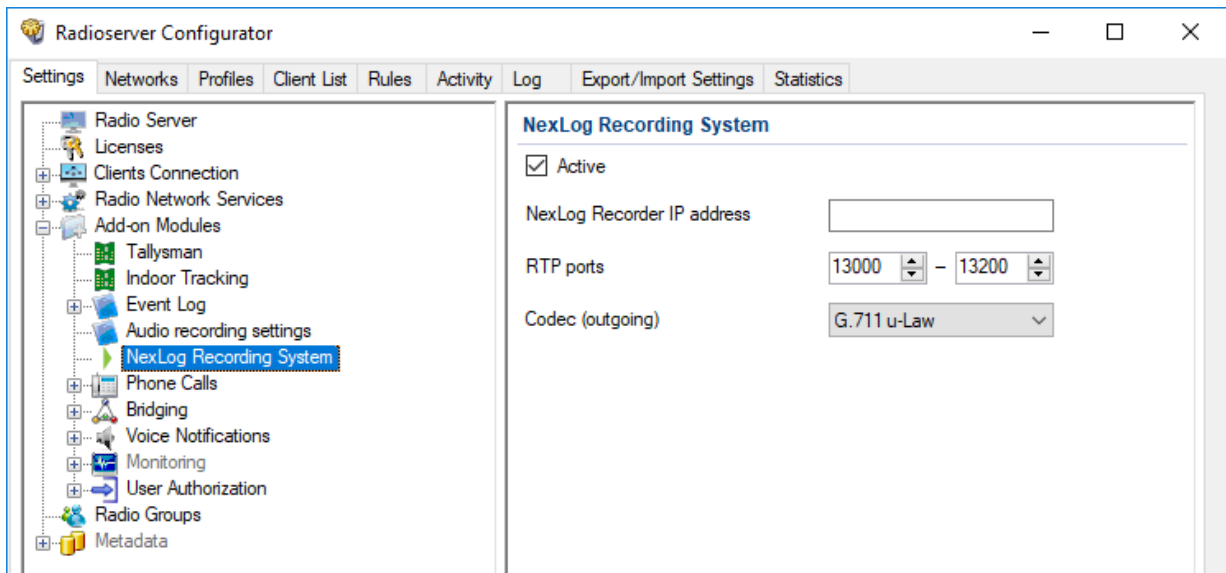

- In the right pane, select the **Active** check box.
- In the **NexLog Recorder IP address** type the IP address or domain name of the recording system considering the network address translation (if used).
- In the **RTP ports** fields, enter the minimum and maximum port numbers for RTP/UDP traffic that determine a port range allocated in NexLog for SmartPTT connection. Consider the network address translation (if used).

NOTE

Number of ports is related to the buffer size only, not to the number of simultaneous voice streams.



- From the **Codec (outgoing)** list, select the desired element:

If NexLog uses the A-Law algorithm,	select <i>G.711 A-Law</i> .
-------------------------------------	-----------------------------

If NexLog uses the μ -Law algorithm, `select G.711 u-Law.`

7. To save changes, at the bottom of the SmartPTT Radioserver Configurator window, click **Save Configuration** ().

Postrequisites:

To apply changes immediately, at the bottom of the SmartPTT Radioserver Configurator window, click **Start** () or **Restart** ().

4.7.3 Monitoring Database

SmartPTT network monitoring database stores the following events information:

- Relative radio signal strength (RSSI).
- Radio network equipment status.
- Alarms information.

Important

Monitoring database is available only if the SmartPTT license allows network monitoring. For details, see [Viewing License Items](#).

Monitoring database must be connected and configured to provide the following SmartPTT features:

- MOTOTRBO radio systems and control stations monitoring. For details, see [MOTOTRBO Radio Systems](#).
- Third-party SNMP services integration. For details, see [External SNMP Services](#).
- Automatic alarm notifications that can be addressed to radio network, phone numbers (SMS), email addresses, or external SNMP services. For details, see [Network Monitoring](#).
- RF coverage map calculation. For details, see "Coverage Map" in *SmartPTT Dispatcher Guide*.
- Radio channels monitoring. For details, see "Air Monitoring" in *SmartPTT Dispatcher Guide*.
- Generating monitoring reports. For details, see "Reports" in *SmartPTT Dispatcher Guide*.

Monitoring Database Configuration

To configure the event log database, the following actions must be performed:

- SmartPTT license with network monitoring permission must be installed. For details, see [Installing License](#).
- Database management system must be configured. For details, see [DBMS Configuration](#).
- Radioserver must be connected to the database. For details, see [Configuring Monitoring Database Connection](#).
- Database retention policy must be configured. For details, see [Configuring Monitoring Database Retention Policy](#).
- Database automatic backup must be configured. For details, see [Configuring Monitoring Database Autobackup](#).

4.7.3.1 Configuring Monitoring Database Connection

Follow the procedure to configure the monitoring database connection.

Prerequisites:

- Ensure that the SmartPTT license allows network monitoring. For details, see [Viewing License Items](#).
- Obtain IP address/domain name of the DBMS host.
- Obtain DBMS process name.
- If DBMS-controlled authorization is used, obtain the corresponding credentials. For details, see [Adding SQL Server Users](#).

Procedure:

1. In SmartPTT Radioserver Configurator, open the **Settings** tab.
2. In the left pane, expand the **Add-on Modules** node, and then click **Monitoring**.
The monitoring settings appear in the right pane.

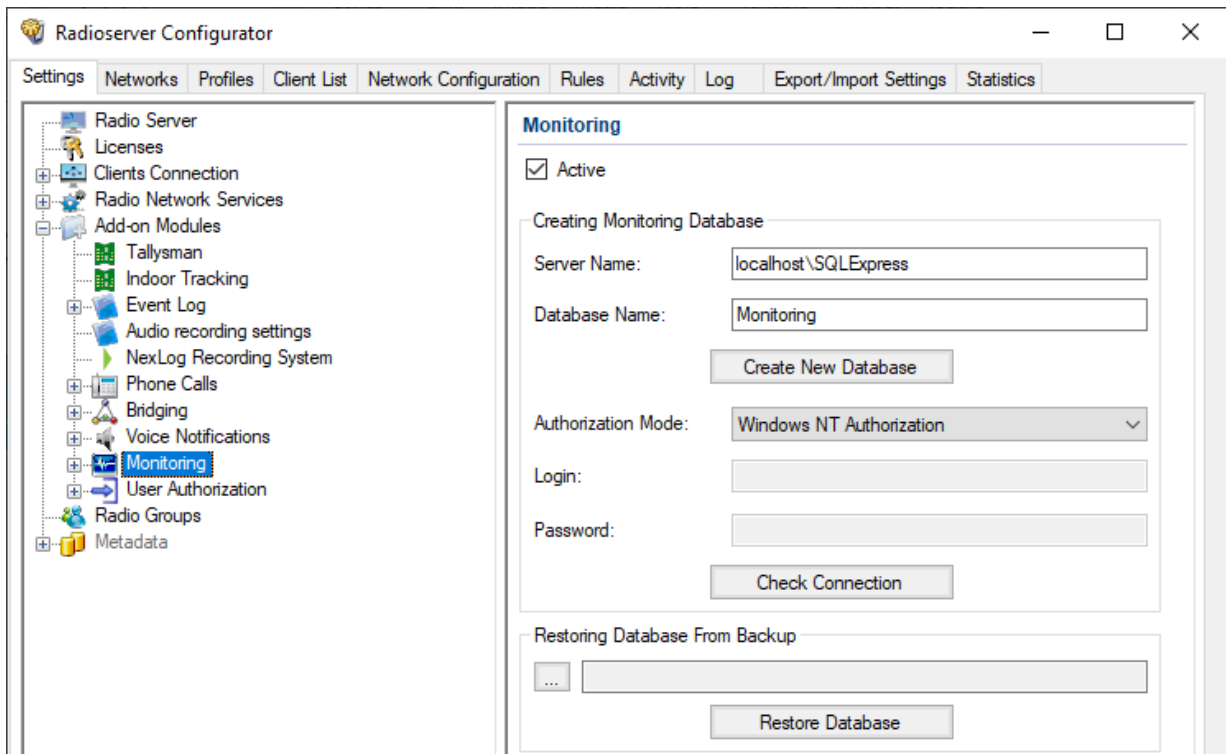

3. Select the **Active** check box.
4. In the **Server Name** field, type the DBMS address in the following format:
<IP Address or Host Name>\<Process Name>.
5. In the **Database Name** field, type the database name.
6. Configure authorization:

To use Windows authorization,

from the **Authorization Mode** list, select *Windows NT Authorization*.



To use DBMS-controlled authorization,

perform the following actions:

1. From the **Authorization Mode** list, select *SQL Server Authorization*.
2. In the **Login** field, type the user login.
3. In the **Password** field, type the user password.

7. Click **Create New Database** to create a database with the specified parameters.
A success or error message appears.
8. *(Optional)* Click **Check Connection** to check the connection with SQL Server and access to the database.
A success or error message appears.
9. To save changes, at the bottom of the SmartPTT Radioserver Configurator window, click **Save Configuration** ().

Postrequisites:

- Configure the database retention policy. For details, see [Configuring Monitoring Database Retention Policy](#).
- Configure the database automatic backup. For details, see [Configuring Monitoring Database Autobackup](#).
- To apply changes immediately, at the bottom of the SmartPTT Radioserver Configurator window, click **Start** () or **Restart** ().

4.7.3.2 Configuring Monitoring Database Retention Policy

Follow the procedure to configure the database retention policy. This helps to avoid database overflow and save the disk space.

Prerequisites:

Configure the monitoring database connection. For details, see [Configuring Monitoring Database Connection](#).

Procedure:

1. In SmartPTT Radioserver Configurator, open the **Settings** tab.

- In the left pane, expand **Add-on Modules** → **Monitoring**, and then click **Settings**.
The monitoring database cleanup settings appear in the right pane.

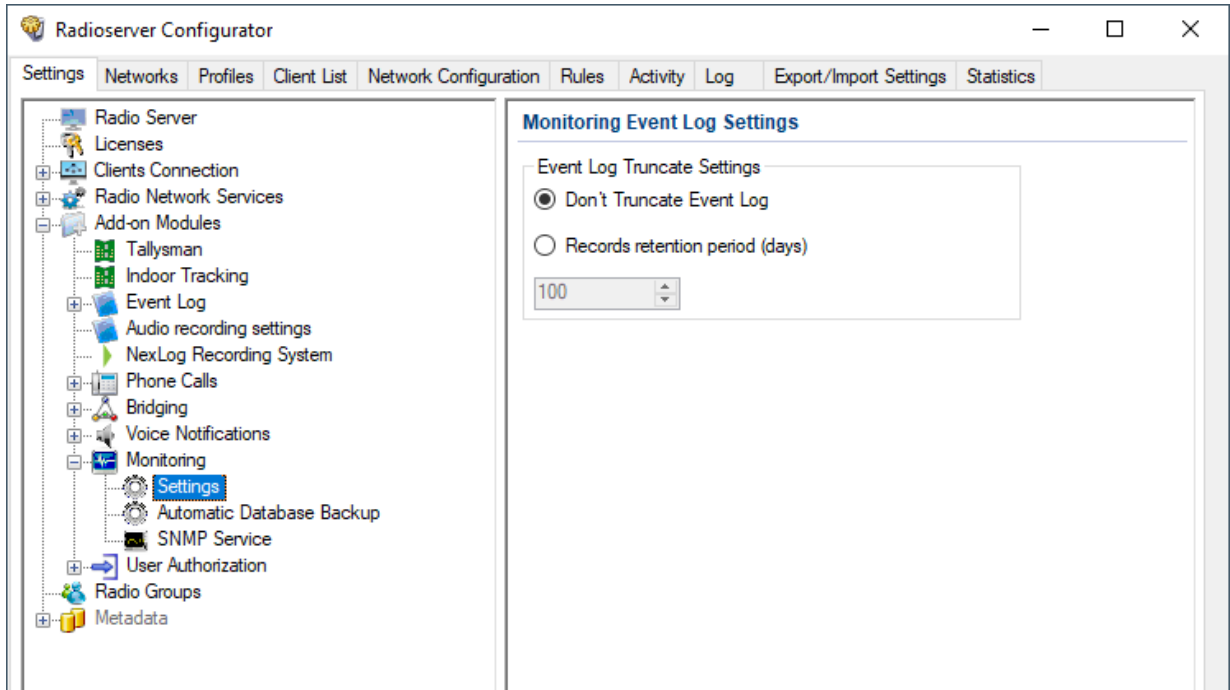

- In the right pane, perform one of the following actions:

To prevent log entries deletion from the database,

click **Do not clear event log**.

To delete outdated event entries,

perform the following actions:



- Click **Records retention period (days)**.
- In the unlocked field, enter the retention period duration (in days).

NOTE

If you enter 0, database will store only the current day events.

- To save changes, at the bottom of the SmartPTT Radioserver Configurator window, click **Save Configuration** ().

Postrequisites:

To apply changes immediately, at the bottom of the SmartPTT Radioserver Configurator window, click **Start** () or **Restart** ().

4.7.3.3 Configuring Monitoring Database Autobackup

Follow the procedure to configure the monitoring database automatic backup.

Prerequisites:

- Configure the monitoring database connection. For details, see [Configuring Monitoring Database Connection](#).
- Determine the backup storage.
- Create the backup creation schedule.

Procedure:

1. In SmartPTT Radioserver Configurator, open the **Settings** tab.
2. In the left pane, expand **Add-on Modules** → **Monitoring**, and then click **Automatic Database Backup**. The backup settings appear in the right pane.

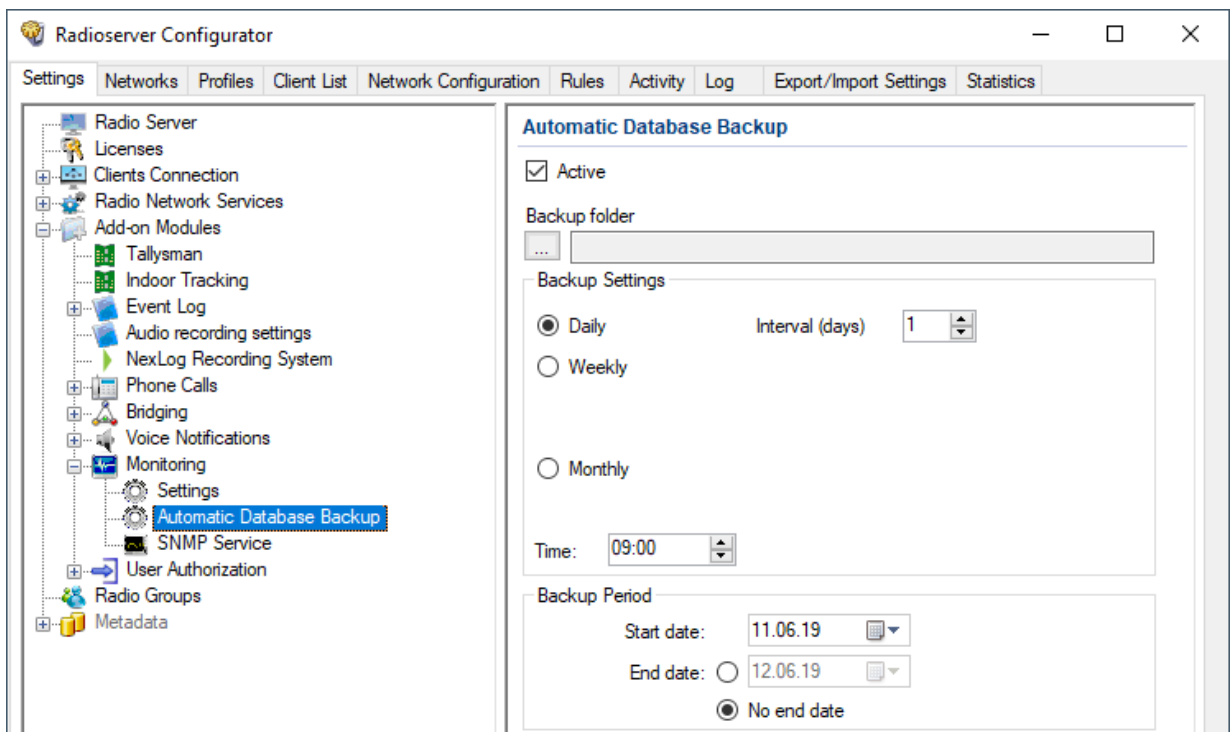

3. Select the **Active** check box.
4. Determine the backup storage directory:
 - a. Click the Browse () button to the left of the **Backup folder** field. Browse dialog box appears.
 - b. In the dialog box, specify the directory, and then click **OK**.
5. In the **Backup Settings** area, configure the backup period:

To create backups once in several days,

perform the following actions:

1. Click **Daily**.

2. In the **Interval (days)** field, enter the number of days between backups (1 means daily backups).

To create backups on specific days of week with the specific time period,

perform the following actions:

1. Click **Weekly**.
2. Select check boxes that are related to the days of week when the backup must be created.
3. In the **Interval (weeks)** field, enter the number of weeks between backups (1 means weekly backups).

To create backups once in several months,

perform the following actions:

1. Click **Monthly**.
2. In the **Day of month** field, enter the day of month when the database backup starts.
3. In the **Interval (month)** field, enter the number of months between backups (1 means monthly backups).

6. In the **Time** field, enter the time of the day when the database backup creation starts.
7. (Optional) In the **Backup Period** area, configure start and end dates of the time interval when the backups must be created:
 - a. In the **Start date** field, enter the start date of the backup creation.
 - b. Configure the end date of the time interval:

To unset the end date,

click **No end date**.



To specify the end date,

perform the following actions:

1. Click **End date**.
2. In the unlocked field, enter the end date.

8. To save changes, at the bottom of the SmartPTT Radioserver Configurator window, click **Save Configuration** ().

Postrequisites:

To apply changes immediately, at the bottom of the SmartPTT Radioserver Configurator window, click **Start** () or **Restart** ().

4.7.4 Event Viewer

Radioserver saves system events into the operating system event log. For example, it adds the following types of events into the log:

- Dispatch console connection to the radioserver.
- Radioserver service stop.

Events are available to view using the Windows Event Viewer. Radioserver log in that app is named **SmartPTT**. It is available alongside other applications and services logs.

For information on Event Viewer and the log, see the [Event Viewer](#) page on the Microsoft Docs website.

4.8 Configuring Black/White Lists

Follow the procedure to configure black/white list of radios.

Prerequisites:

- Configure Radio Disable reception in radio codeplugs.
- Create the desired radio groups. For details, see [Managing Radio Groups](#).

Procedure:

1. In SmartPTT Radioserver Configurator, open the **Settings** tab.
2. In the left pane, expand **Radio Network Services**, and then click **Radio Blacklist**.
The radio blacklist settings appear in the right pane.

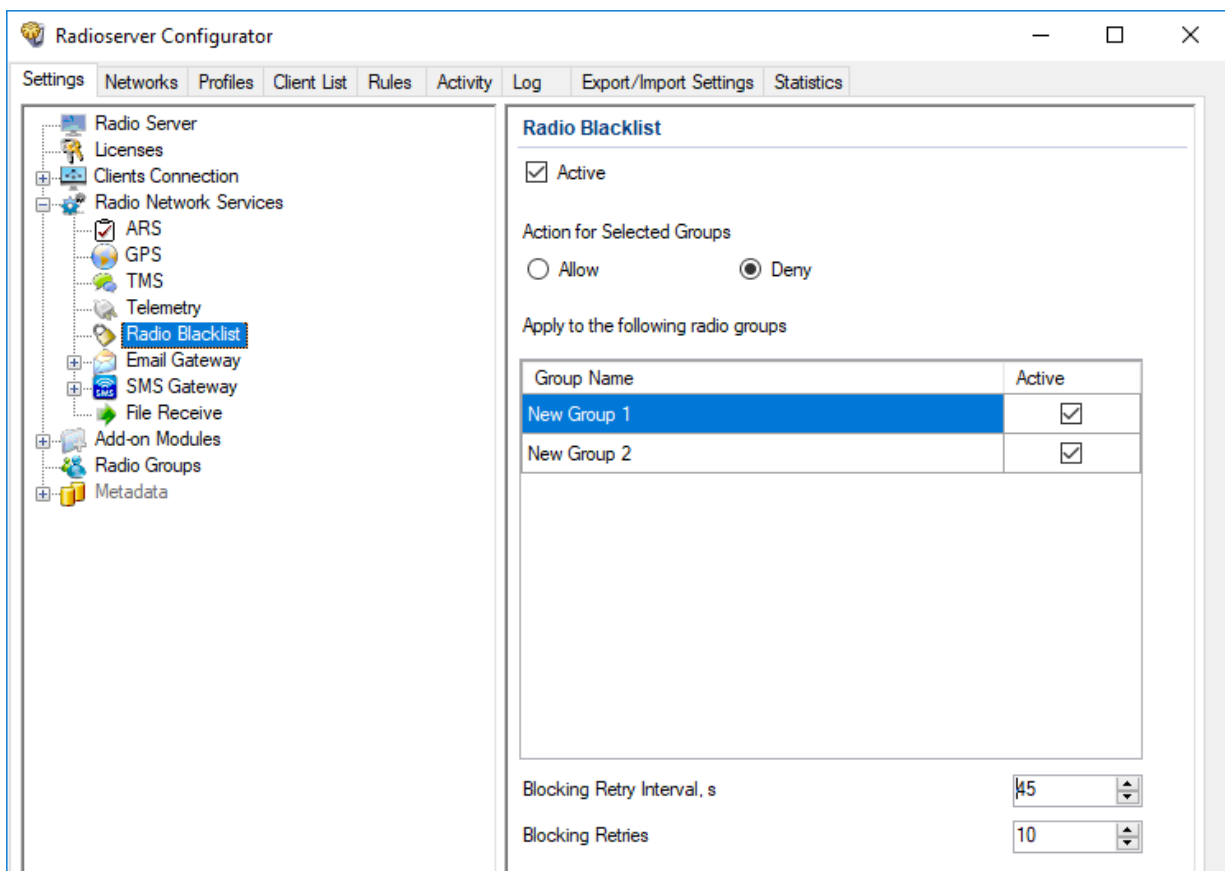



3. Select the **Active** check box.
4. In the **Action for Selected Groups** area, select one of the following actions:

To deny access to the radio network for all radios except included in the selected groups,	select the Allow option.
---	---------------------------------

To deny access to the radio network for all radios included in the selected groups,	select the Deny option.
--	--------------------------------

5. In the table, in the **Active** column, select the check box for groups that must be included in blacklist/whitelist.
6. In the **Blocking Retry Interval s** field, enter the minimum interval (in seconds) between attempts to block the same radio.
7. In the **Blocking Retries** field, enter the maximum quantity of attempts to block the same radio.
8. To save changes, at the bottom of the SmartPTT Radioserver Configurator window, click **Save Configuration** ().

Postrequisites:

To apply changes immediately, at the bottom of the SmartPTT Radioserver Configurator window, click **Start** () or **Restart** ().

5 MOTOTRBO Radio Systems

SmartPTT supports direct (wireline) connection to the following MOTOTRBO™ repeater systems:

- Single-site conventional systems. For details, see [Single-Site MOTOTRBO Systems](#).
- IP Site Connect. For details, see [IP Site Connect](#).
- Capacity Plus (Capacity Plus Single Site). For details, see [Capacity Plus](#).
- Linked Capacity Plus (Capacity Plus Multi-Site). For details, see [Linked Capacity Plus](#).
- Capacity Max. For details, see [Capacity Max](#).
- Connect Plus. For details, see [Connect Plus](#).

SmartPTT also supports control stations. For details, see [MOTOTRBO Control Stations](#).

5.1 Single-Site MOTOTRBO Systems

Single-site systems are radio systems with single repeater. Such systems may operate in one of two modes:

Regular Mode

In this mode, radio channel is a duplex channel (receive and transmit radio frequencies are different). SmartPTT accesses such systems in the same way as it accesses IP Site Connect. For details, see [IP Site Connect Configuration \(NAI\)](#).

Extended Range Direct Mode (ERDM)

In this mode, radio channel is a simplex channel (receive and transmit frequencies are equal) with time-slots utilized as receive and transmit channels. SmartPTT accesses such systems over NAI. For details, see [ERDM Systems](#).

To allow SmartPTT connection, repeater must have the IP Site Connect license installed. For details, contact Motorola Solutions representative in your region.

5.1.1 ERDM Systems

Extended Range Direct Mode (ERDM) is a special operation mode of a single-site digital (MOTOTRBO) radio system. Such systems are also known as Single Frequency Repeaters (SFR).

In ERDM, radio channel is configured as a simplex channel (receive and transmit frequencies are equal). At the same time, receive and transmit channels are assigned to DMR time slots. As a result, systems operate in the following way:

- Single radio frequency is used.
- First time slot is used to transmit information.
- Second time slot is used to receive information.

This mode provides the ability to save customer's expenses on radio frequency licensing. For other details, contact Motorola Solutions representative in your region.

SmartPTT is able to connect to multiple repeaters that operate in ERDM. As a result, it increases RF coverage area.

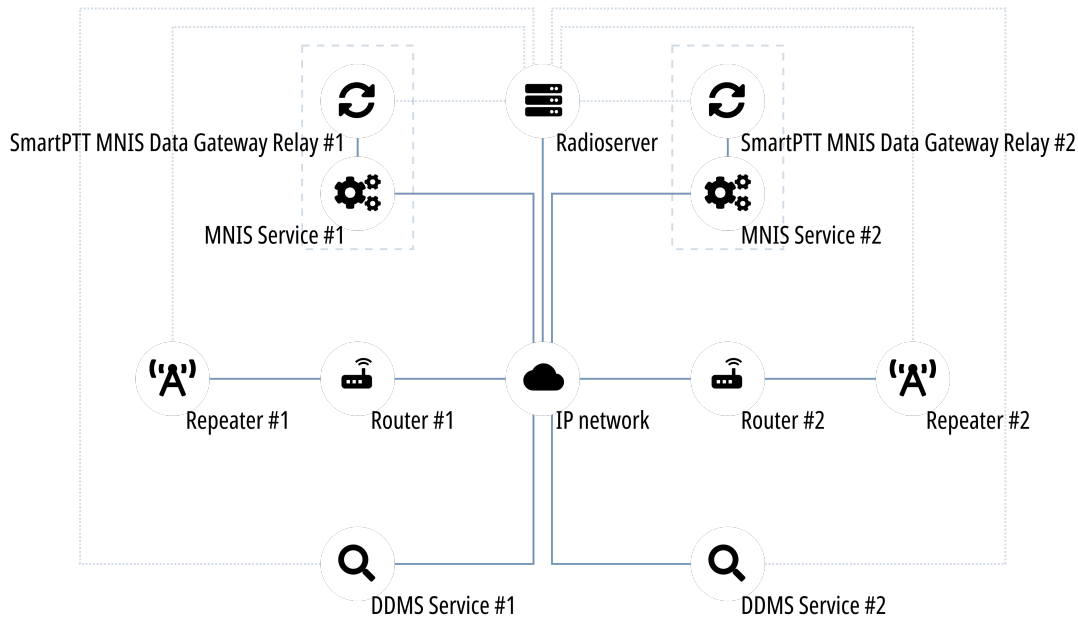

To access the repeater, SmartPTT uses Network Application Interface (NAI). The interface is provided by Motorola Solutions and its usage requires the following additional software:

- MOTOTRBO Network Interface Service (MNIS) provides data communication between the single-site system and SmartPTT.
- Device Discovery and Mobility Service (DDMS) provides ARS and (if configured) radio user information to SmartPTT.

Each repeater connection requires its own MNIS and DDMS.

Radioserver requires simultaneous connection to repeater, MNIS, and DDMS (see dotted lines on the diagram). To access the MNIS service that is installed on the dedicated computer (not on the SmartPTT Radioserver host), SmartPTT MNIS Data Gateway Relay is required. For details, see [Configuring SmartPTT MNIS Data Gateway Relay](#).

5.1.2 SmartPTT Features in ERDM

Repeater that operates in ERDM is able to provide the following features to SmartPTT:

- Radio registration information (ARS).
- Radio user identification.
- Radio location updates.
- Text messaging and job ticketing.
- Telemetry and remote control over radios.

Important

SmartPTT does **not** support voice calls and radio commands in such systems.

Based on provided features, SmartPTT implements the following features:

- Simultaneous connection to multiple ERDM-operating repeaters.
- Event logging.
- Rules configuration.

For network monitoring, the following features are provided:

- IP devices monitoring over SNMP.
- Over-the-air traffic monitoring.
- Network topology visualization.

NOTE

SmartPTT does **not** show on-site/fielded radios on topology diagrams.

- Statistical information gathering (system performance, alarm statistics), reports generation.

5.1.3 ERDM Systems Configuration

SmartPTT connection to ERDM-operating repeater requires the following:

- Radio system compliance with the planning requirements.
- MNIS and DDMS configuration.
- Additional radio devices configuration.
- Dispatch software configuration.

Important

All of the following information (except SmartPTT configuration) is dedicated to the minimum configuration required to include dispatch software to the radio system. It is **not** sufficient for the whole system operation in ERDM. For more information and/or configuration assistance, contact Motorola Solutions representatives in your region.

Planning Requirements

To support SmartPTT connection, the radio system must comply with the following requirements:

- Repeater features must include the following items:
 - IP Site Connect.
 - Extended Range Direct Mode.
 - Data over NAI.
- Repeater and all radios must have the same CAI IDs and CAI Group IDs.
- If radioserver, repeater, MNIS, and/or DDMS are in different networks controlled by different routers, corresponding routers must support Network Address Translation (NAT).
- Security key IDs and values must be known to people who will configure radios, MNIS, and radioserver.

Important

MOTOTRBO software and firmware do **not** provide tools to view the configured security/privacy key.

MNIS and DDMS Configuration

To configure MNIS and DDMS, the following actions must be performed:

- MNIS must have the following IDs:
 - Free Radio ID
 - Free Repeater Radio ID
- MNIS must be connected to the ERDM-operating repeater over IP.
- MNIS must be connected to DDMS.

Additional Radio Devices Configuration

To configure radio devices to operate together with SmartPTT in ERDM-operating systems, the following actions must be performed:

- For all radios, MNIS Radio IDs must be used as ARS ID.
- All routers must be configured to translate the following addresses:
 - Repeater
 - Radioserver
 - MNIS service
 - DDMS service

SmartPTT Configuration

To configure SmartPTT, the following actions must be performed:

- SmartPTT license with conventional (IPSC) systems permission must be installed. For details, see [Installing License](#).
- Repeater connection must be configured. For details, see [Adding and Editing ERDM System Configuration](#).
- Radioserver identification must be performed. For details, see [Configuring SmartPTT Identification in ERDM](#).
- Talkgroups must be configured. For details, see [Adding and Editing Groups in ERDM](#).
- SmartPTT must be connected to DDMS. For details, see [Configuring DDMS Connection](#).
- SmartPTT must be connected to MNIS. For details, see [Configuring MNIS Data Gateway](#).

If you need assistance in the SmartPTT configuration, submit a request to [SmartPTT Technical Support Center](#).

5.1.3.1 Adding and Editing ERDM System Configuration

Follow the procedure to add a new or edit an existing connection to the radio system.

Prerequisites:

- Ensure that SmartPTT license allows data exchange in conventional (IPSC) systems.
- From the repeater codeplug, obtain the following data:
 - Repeater IP address and UDP port number.
 - Repeater private authentication key.
- If the repeater and radioserver are in different networks controlled by different routers over the router that supports Network Address Translation (NAT), obtain the IP address and UDP port that will be translated to the master repeater IP address and UDP port number.
- *(Optional)* Turn on SmartPTT monitoring. For details, see [Configuring Monitoring Database Connection](#).

Procedure:

1. In SmartPTT Radioserver Configurator, open the **Networks** tab.
2. In the left pane, perform one of the following actions:

To add a new network,

right-click the **NAI Systems** node, point to **Add**, and then select **NAI - Extended Range Direct Mode**.

To modify an existing network,

expand the **NAI Systems** node, and then click **<network name>**.

The connection settings appear in the right pane of the tab.

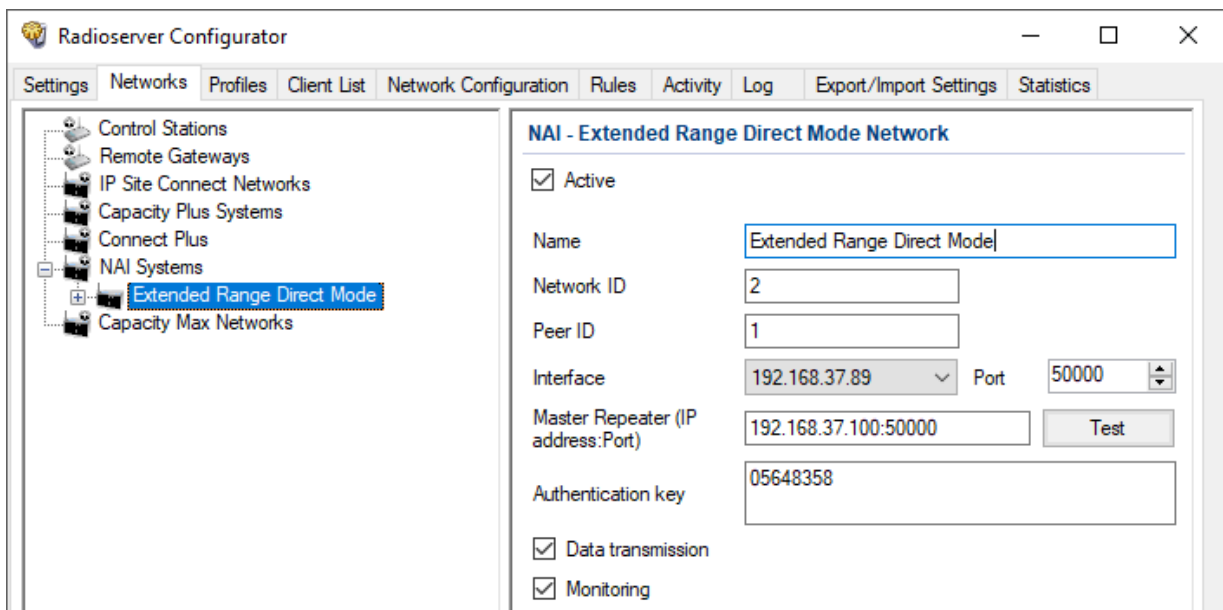

3. In the right pane, configure the general connection settings:
 - a. Select the **Active** check box.
 - b. In the **Name** field, type the radio system name.
 - c. Leave the value in the **Network ID** field unchanged.
4. Configure the repeater connection:
 - a. In the **Peer ID** field, type the ID of the virtual repeater reserved for a radioserver.
 - b. From the **Interface** list, select one of the following options:

To use any of the radioserver host IP addresses (except 127.0.0.1), select *Any*.

To fix the IP address, select the desired IP address.

Important



If a radioserver and MNIS are installed on the same computer, use fixed IP address that is different from the MNIS Tunnel IP address (by default, *192.168.56.1*).

Important

If a radio or control station is connected to the computer, use fixed IP address that is different from the radio or control station IP address (by default, *192.168.10.1*).

- c. In the **Port** field, enter the radioserver host port that will be used to connect to the repeater.
 - d. In the **Master Repeater (IP address:Port)** field, type the IP address and UDP port that a radioserver will use to connect to the repeater (includes the potential NAT use). Input format is `<IP address in dot-decimal notation>:<UDP port>`.
 - e. In the **Authentication key** field, type the repeater private authentication key.
 - f. *(Optional)* Click **Test** to check the connection.
5. Select the **Data transmission** check box to turn on data exchange between a radioserver, MNIS, and DDMS.
6. *(Optional)* Select the **Monitoring** check box to turn on the radio system devices diagnostics.
7. To save changes, at the bottom of the SmartPTT Radioserver Configurator window, click **Save Configuration** ()

Postrequisites:

- Identify a radioserver in the system. For details, see [Configuring SmartPTT Identification in ERDM](#).
- Configure talkgroups in the network. For details, see [Adding and Editing Groups in ERDM](#).
- To apply changes immediately, at the bottom of the SmartPTT Radioserver Configurator window, click **Start** () or **Restart** ()
- *(Optional)* Configure network device monitoring.

5.1.3.2 Configuring SmartPTT Identification in ERDM

Follow the procedure to configure SmartPTT identification in the radio network.

Prerequisites:

- Add and configure SmartPTT connection to the ERDM repeater. For details, see [Adding and Editing ERDM System Configuration](#).
- From radio codeplugs, obtain the following data:
 - CAI and CAI group values.
 - CSBK data settings (active or inactive).
- From the MNIS configuration file, obtain information on the repeater location (configured or not).

Procedure:

1. In SmartPTT Radioserver Configurator, open the **Networks** tab.
2. In the left pane, expand **NAI Systems** → **<system name>**, and then click **<slot name>**.
The identification parameters appear in the right pane of the tab.

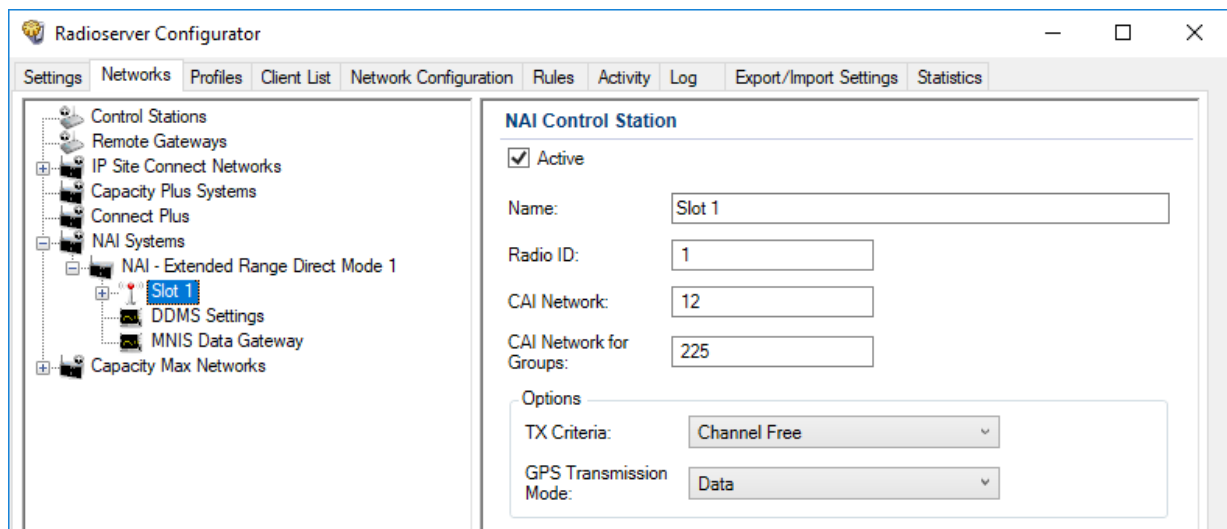

3. In the right pane, select the **Active** check box.
4. In the **Name** field, type the title that will represent the radio network in SmartPTT Dispatcher.
5. Type the radioserver identification parameters:
 - a. In the **Radio ID** field, type one of unused radio IDs.
 - b. In the **CAI Network** field, type the CAI ID.
 - c. In the **CAI Network for Groups** field, type the CAI Group ID.
6. From the **TX Criteria** list, select one of the following options:

If the call initiator must transmit only when no other transmissions is detected over the radio channel, select *Channel Free*.

If the call initiator must interrupt another participant of the radio network according to the selected MSI or DMR protocol,

select *Tx Interrupt*.

If the call initiator must completely ignore other transmissions over the radio channel,

select *Always*.

-
7. From the **GPS Transmission Mode** list, select one of the following options:

If CSBK data is used in the radio system but site coordinates are **not** configured in MNIS,



select *CSBK*.

In CSBK data is **not** used in the radio system or outdoor location service is used together with indoor positioning service,

select *Data*.

-
8. To save changes, at the bottom of the SmartPTT Radioserver Configurator window, click **Save Configuration** ().

Postrequisites:

To apply changes immediately, at the bottom of the SmartPTT Radioserver Configurator window, click **Start** () or **Restart** ().

5.1.3.3 Adding and Editing Groups in ERDM

Follow the procedure to add or edit talkgroups in the radio system.

Prerequisites:

- Add and configure SmartPTT connection to the ERDM repeater. For details, see [Adding and Editing ERDM System Configuration](#).
- From radio codeplugs, obtain the list of talkgroup IDs.

Procedure:

1. In SmartPTT Radioserver Configurator, open the **Networks** tab.

- In the left pane, expand **NAI Systems** → <system name> → <slot name>, and then click **Talkgroups**.
The list of talkgroups appear in the right pane.

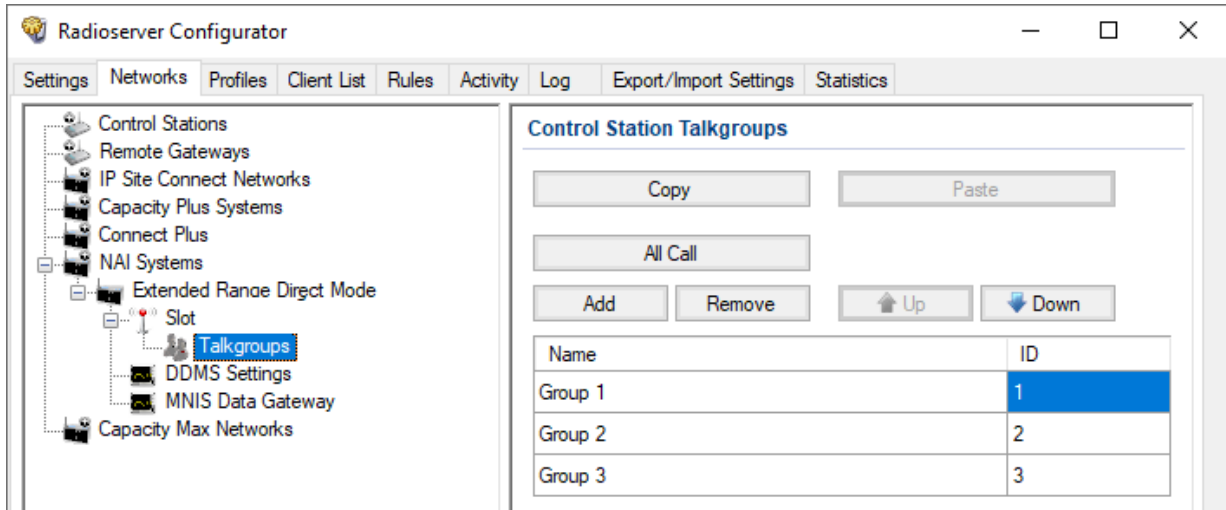

- In the right pane, perform one of the following actions:

To add a new talkgroup,



click **Add**.

To edit an existing talkgroup,

proceed to the next step of the procedure.

- In the desired table entry, perform the following actions:
 - In the **ID** column (if appears), double-click the current ID, and then type the desired talkgroup ID.
 - In the same entry, in the **Name** column, double-click the current name, and then type the desired name.
- (Optional) Using **Up** and **Down** buttons, reorder rows in the table.
- To save changes, at the bottom of the SmartPTT Radioserver Configurator window, click **Save Configuration** ().

Postrequisites:

To apply changes immediately, at the bottom of the SmartPTT Radioserver Configurator window, click **Start** () or **Restart** ().

5.2 IP Site Connect

MOTOTRBO™ IP Site Connect is a digital conventional radio system that is compliant with DMR Tier II standards. The system provides two logical channels over the single duplex channel (using the TDMA technology) and a great RF coverage zone (up to 15 sites per system). For details, see [MOTOTRBO™ IP Site Connect](#) on the Motorola Solutions website.

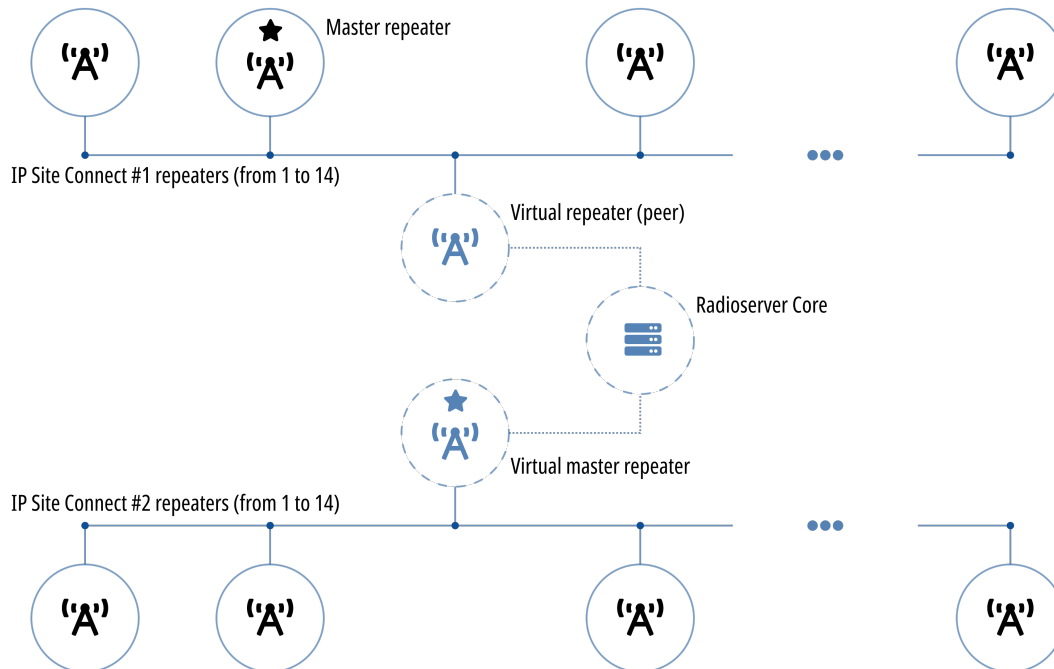

SmartPTT is able to connect to multiple IP Site Connect radio systems at once. This (alongside other features) allows to increase the system RF coverage by configuring SmartPTT bridging.

SmartPTT supports the following interfaces to access IP Site Connect:

- Direct IP connection.
- Network Application Interface (NAI). For details, see [IP Site Connect over NAI](#).

5.2.1 IP Site Connect over NAI

Network Application Interface (NAI) is a dedicated radio system interface for SmartPTT. The interface requires to use the following additional software:

MOTOTRBO Network Interface Service (MNIS)

Software gateway that provides SmartPTT dispatchers with data reception and transmission in the radio network. Data include text messages, job tickets, location requests and reports, telemetry data, and remote control commands. On the computer, MNIS is represented as a Windows service.

Device Discovery and Mobility Service (DDMS)

Software gateway that delivers the radio presence (ARS) information and radio user ID to SmartPTT dispatchers. On the computer, DDMS is represented as a Windows service.

NAI is recommended to use by Motorola Solutions.

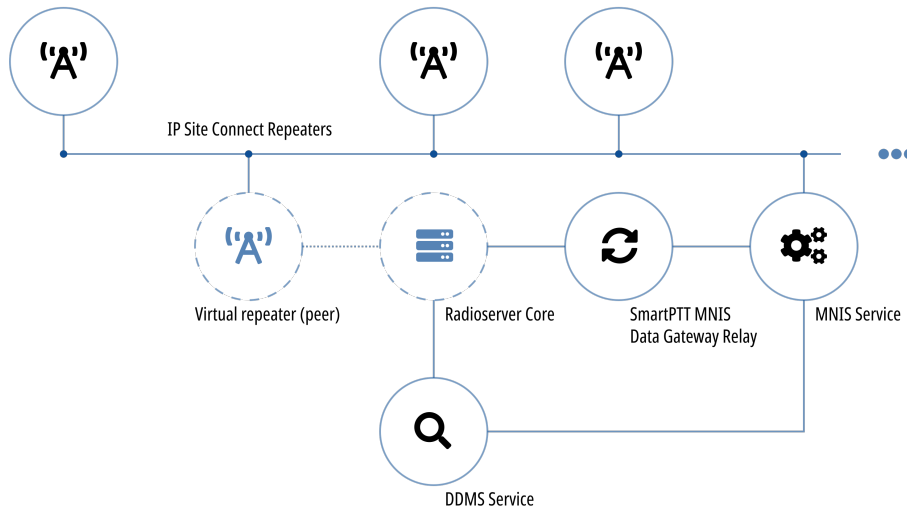

Using NAI provides the following features to SmartPTT users:

- Radio user identification. For details, see [Radio Users](#).
- High rate of the radio location updates (up to 8 times/min).

To use NAI, the SmartPTT license must allow this type of connection to IP Site Connect.

5.2.2 Digital Backhaul

A backhaul system is an IP Site Connect modification where at least two sites have a wireless IP connection. The connection is provided by additional repeaters installed to those sites.

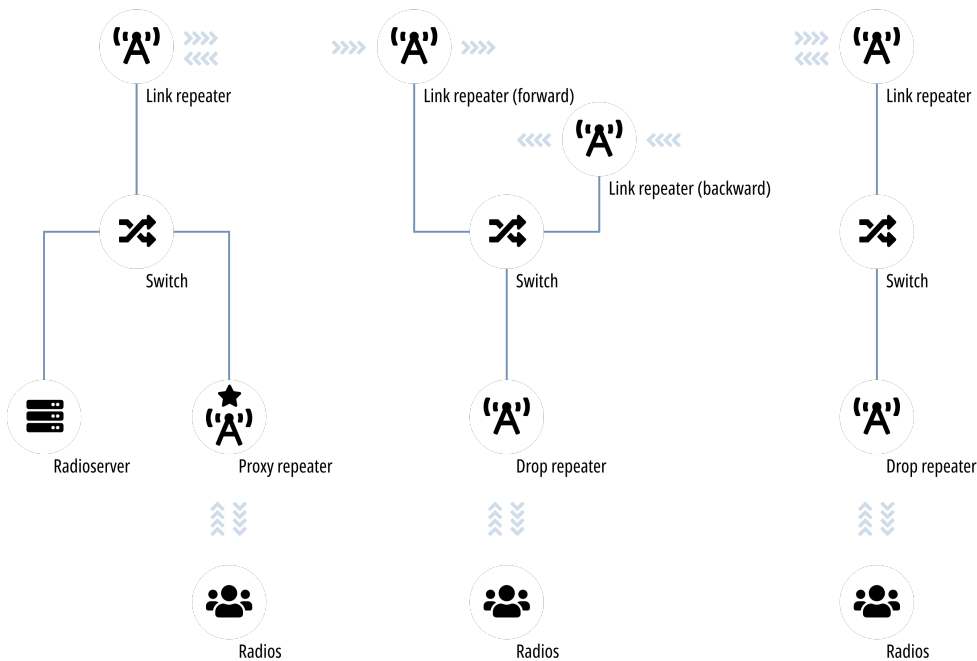

Backhaul systems are necessary if no wireline network equipment can be mounted on the site. For more information, contact Motorola Solutions representative in your region.

In the systems, the following terms are used:

- Origin site is the first site of the backhaul repeater chain.
- Terminating site is the last site of the backhaul repeater chain.
- Drop repeater provides voice and data communication for on-site radios.
- Link repeater provides the inter-site communication.
- Proxy repeater is a drop repeater that provides SmartPTT connection to IP Site Connect.

To use SmartPTT in backhaul systems, the following requirements must be followed:

- Radio system must have the single backhaul repeater chain.
- Proxy repeater must be in the origin or terminating site of that chain.
- Proxy repeater must be the master repeater of the system.

5.2.3 SmartPTT Features in IP Site Connect

IP Site Connect provides the following features to SmartPTT:

- Information on radio presence in the network (ARS).
- Radio location updates (includes revert channel support).
- Text messaging and job ticketing.
- Telemetry and remote control over radios.

With wireline connection, IP Site Connect provides the following features to SmartPTT:

- Voice call reception and initiation (includes group calls and private calls).
- Emergency alarms and calls.
- Radio commands.

Important

Features provided by the direct IP connection are **unavailable** for NAI.

SmartPTT provides the following features for IP Site Connect users:

- Simultaneous access to multiple systems.
- Integration with other radio systems using cross patches, bridging, and conference calls (direct connection only).
- Telephone interconnect over SIP trunk (direct connection only).
- Event logging and voice recording (voice recording is available for direct connection only).
- Per-console and system-wide rules.
- Availability for Web Client users, SmartPTT Mobile users, and API-applications.

For network monitoring purposes, the following features are available:

- Network device monitoring over SNMP.

- Logical and physical channel monitoring (also referred to as “air monitoring”).
- Radio network topology visualization.

NOTE

SmartPTT does **not** show on-site/fielded radios on topology diagrams.

- Statistical information gathering (system performance, alarm statistics), reports generation.

5.2.4 IP Site Connect Configuration (direct)

Wireline connection to IP Site Connect requires additional radio devices configuration and dispatch software configuration.

Radio Devices Configuration

To support SmartPTT connection, the following actions must be performed:

- Radio IDs must be reserved for the following needs:
 - Dispatch subsystem (SmartPTT) identification.
 - *(Optional)* Individual dispatcher identification.
- Peer ID must be reserved for SmartPTT identification as a software peer.
- SmartPTT Radio ID must be configured as the ARS ID in all radio codeplugs.
- All radios and repeaters must have the same CAI IDs and CAI Group IDs.
- IP address and UDP port of the master repeater must be obtained.
- Time interval of network delay between repeaters must be set the same for all repeaters.
- Security keys configured in radio codeplugs must be obtained.

If you need assistance in the MOTOTRBO devices configuration, contact Motorola Solutions representatives in your region.

SmartPTT Configuration

To configure SmartPTT to work in IP Site Connect, the following actions must be performed:

- Connection to the master repeater must be configured. For details, see [Adding and Editing IP Site Connect](#).
- SmartPTT Radioserver must be identified on both logical channels (time slots) of the system. For details, see [Configuring Slots](#).
- Talkgroups and All Calls must be configured for all logical channels (time slots). For details, see [Adding and Editing Talkgroups](#).
- Security keys must be configured in SmartPTT. For details, see [Configuring Encryption](#).

If you need assistance in the SmartPTT configuration, submit a request to [SmartPTT Technical Support Center](#).

Network Monitoring

For network monitoring configuration in SmartPTT, the following actions must be performed:

- IP addresses of all repeaters in the system must be obtained.
- IP addresses of all other network devices must be obtained. This includes uninterruptible power supplies (UPS), switches, routers, etc.

5.2.4.1 Adding and Editing IP Site Connect

Follow the procedure to add new or edit an existing IP Site Connect in SmartPTT Radioserver Configurator.

Prerequisites:

- Ensure that SmartPTT has the license that unlocks the use of IP Site Connect. For details, see [Installing License](#).
- Determine the radioserver role as a virtual network repeater (master or peer).
- If the radioserver will be used as a peer repeater, obtain the following information:
 - IP address and UDP port of a master repeater.
 - If a router with Network Address Translation (NAT) is used between master repeater and the radioserver, obtain the IP address and port number that are translated on it to the IP address and UDP port of the master repeater.
- From codeplugs of repeaters, obtain the following information:
 - Repeater private authentication key.
 - Time interval of network delay between repeaters.
- From codeplugs of radios, obtain the following information:
 - Preamble duration (repeater transmission delay).
 - Duration of hang time for group, private, and emergency calls.

Procedure:

1. In SmartPTT Radioserver Configurator, open the **Networks** tab.
2. In the left pane, perform one of the following actions:

To add a new network,

right-click the **IP Site Connect Networks** node, and then click **Add**.



To edit an existing network,

expand the **IP Site Connect Networks**, and then click the desired network.

3. (Optional) Click **Test** to check the connection between the radioserver and master repeater.

10. Leave the **Passive ARS** check box unchanged.
11. In the **TX preamble duration (ms)** field, type the repeater transmission delay (in milliseconds).
12. In the **Messaging Delay, ms** field, type the minimum time interval (in milliseconds) of network delay between repeaters.
13. In the **Group Call Hang Time, ms** field, type the duration (in milliseconds) of hang time for group calls in the system.
14. In the **Private Call Hang Time, ms** field, type the duration (in milliseconds) of hang time for private calls in the system.
15. In the **Emergency Call Hang Time, ms** field, type the duration (in milliseconds) of hang time for emergency calls in the system.
16. In the **Authentication Key** field, type the repeater private authentication key.
17. To save changes, at the bottom of the SmartPTT Radioserver Configurator window, click **Save Configuration** ().

Postrequisites:

- If the radioserver is selected as a master repeater, ensure that its IP address is set in codeplugs of other network repeaters.
- Configure slots. For details, see [Configuring Slots](#).
- Configure talkgroups. For details, see [Adding and Editing Talkgroups](#).
- Configure encryption of transmissions in the network. For details, see [Configuring Encryption](#).
- To apply changes immediately, at the bottom of the SmartPTT Radioserver Configurator window, click **Start** () or **Restart** ().

5.2.4.2 Configuring Slots

Follow the procedure to configure slots in IP Site Connect.

Prerequisites:

- Set the network settings. For details, see [Adding and Editing IP Site Connect](#).
- Determine the slot role (for voice and data transmission or for data transmission only).
- From codeplugs of radios, obtain the following information:
 - CAI and CAI Group ID values.
 - Maximum duration of voice transmissions.
 - Voice transmission interruption.
- Determine the necessity to confirm emergency signals by the radioserver.

Procedure:

1. In SmartPTT Radioserver Configurator, open the **Networks** tab.
2. In the left pane, expand **IP Site Connect Networks** → **<network name>**.
3. Select the desired slot to configure:

To configure first time slot, click the first node (red).

To configure second time slot, click the second node (blue).

In the right pane, parameters of the selected slot appear.

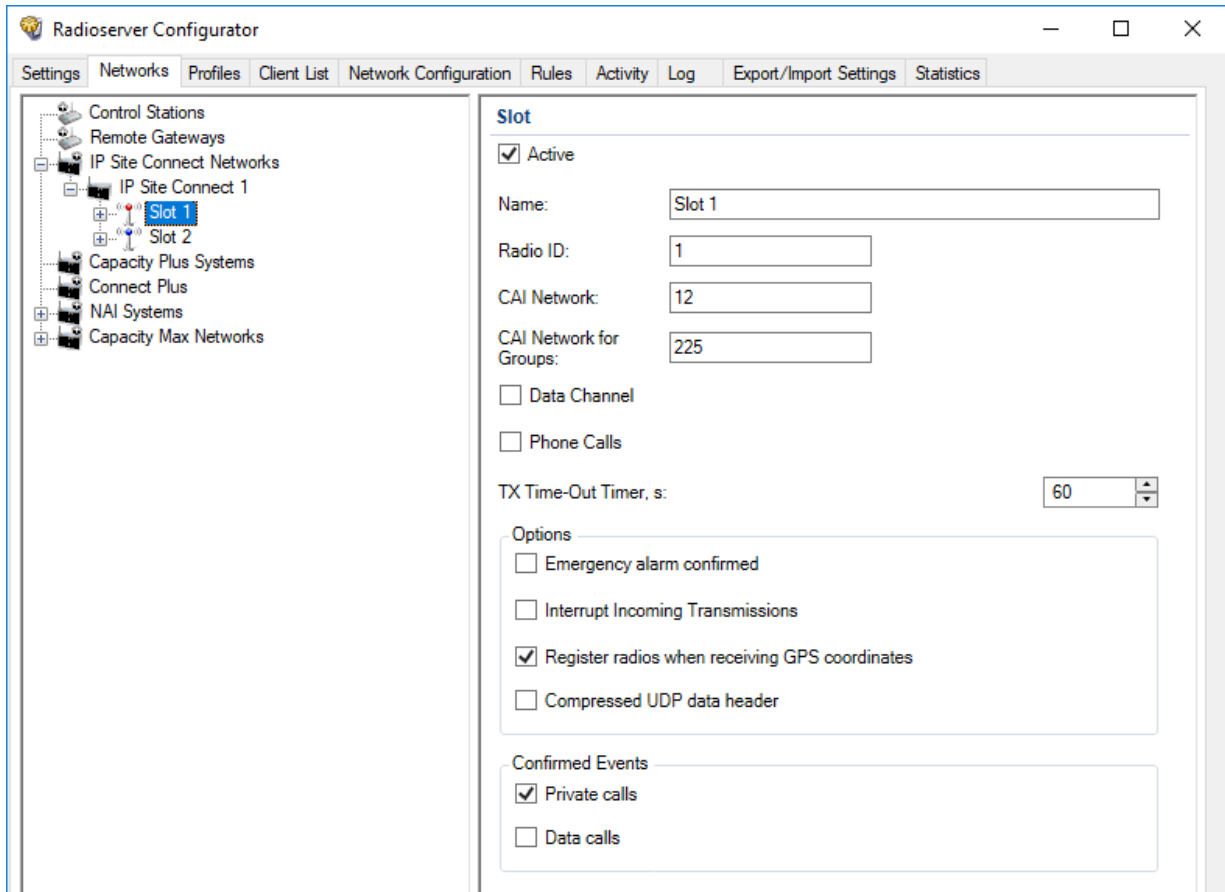

4. Select the **Active** check box to allow slot configuration.
5. In the **Name** field, type the slot name.
6. In the **Radio ID** field, type a unique identifier of the dispatch subsystem in IP Site Connect.
7. In the **CAI Network** field, type a unique CAI ID.
8. In the **CAI Network for Groups** field, type CAI Group ID for groups.
9. Set the slot role:

To configure the slot for data and voice transmission,

perform the following actions:

1. Clear the **Data Channel** check box.
-



2. Select the **Phone Calls** check box to allow voice calls between radios registered on the slot and telephone subscribers.
3. In the **TX Time-Out Timer, s** field, enter the maximum duration (in seconds) of voice transmission on the channel.
4. Select the **Emergency alarm confirmed** check box to enable emergency confirmation by SmartPTT Radioserver.
5. Select the **Interrupt Incoming Transmissions** check box to enable the capability to interrupt voice transmission from radios with a dispatcher voice transmission or voice notification.
6. Select the **Register radios when receiving GPS coordinates** check box to register radios on the slot when receiving their location coordinates.
7. Select the **Private calls** check box to enable private call confirmation.

To configure the slot as a reverse channel,

select the **Data Channel** check box.

10. Select the **Compressed UDP data header** check box to notify SmartPTT Radioserver that radios will send IP packets with compressed headers.
11. Select the **Data calls** check box to enable confirmation of each data packet during transmission.
12. To save changes, at the bottom of the SmartPTT Radioserver Configurator window, click **Save Configuration** ().

Postrequisites:

- Configure talkgroups. For details, see [Adding and Editing Talkgroups](#).
- Configure encryption of transmissions in the network. For details, see [Configuring Encryption](#).
- To apply changes immediately, at the bottom of the SmartPTT Radioserver Configurator window, click **Start** () or **Restart** ().

5.2.4.3 Adding and Editing Talkgroups

Follow the procedure to add or edit talkgroups and All Call on the selected slot.

Prerequisites:

From repeater codeplugs, obtain talkgroup IDs.

Procedure:

1. In SmartPTT Radioserver Configurator, open the **Networks** tab.
2. In the left pane, expand **IP Site Connect Networks** → **<network name>** → **<slot name>**, and then select **Talkgroups**.

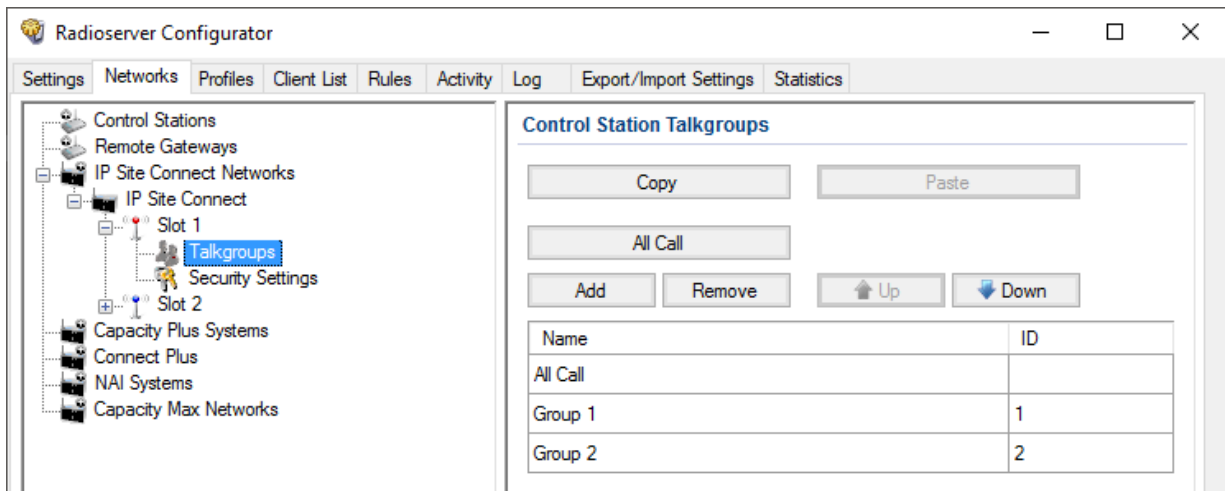

3. In the right pane, perform one of the following actions:

To add a new talkgroup,

click **Add**.

To add an All Call,

click **All Call**.

To edit an existing entry,

proceed to the next step of the procedure.



4. In the table, in the desired entry, perform the following actions:
 - a. In the **Name** column, double-click the current talkgroup or All Call name, and then type the desired name.
 - b. In the **ID** column, double-click the current talkgroup ID, and then type the desired ID.

NOTE

SmartPTT Radioserver Configurator does not show the All Call ID.

5. (Optional) Using **Up** and **Down** buttons, reorder entries in the table.
6. To save changes, at the bottom of the SmartPTT Radioserver Configurator window, click **Save Configuration** ().

Postrequisites:

To apply changes immediately, at the bottom of the SmartPTT Radioserver Configurator window, click **Start** () or **Restart** ().

5.2.4.4 Configuring Encryption

Follow the procedure to add security keys to SmartPTT Radioserver that will be used to encrypt and decrypt transmissions.

Prerequisites:

- Obtain security key IDs and values for all the supported encryption types.
- Determine the encryption type that will be used to encrypt transmissions.

Procedure:

1. In SmartPTT Radioserver Configurator, open the **Networks** tab.
2. In the left pane, expand **IP Site Connect Networks** → **<network name>** → **<slot name>**, and then select **Security Settings**.

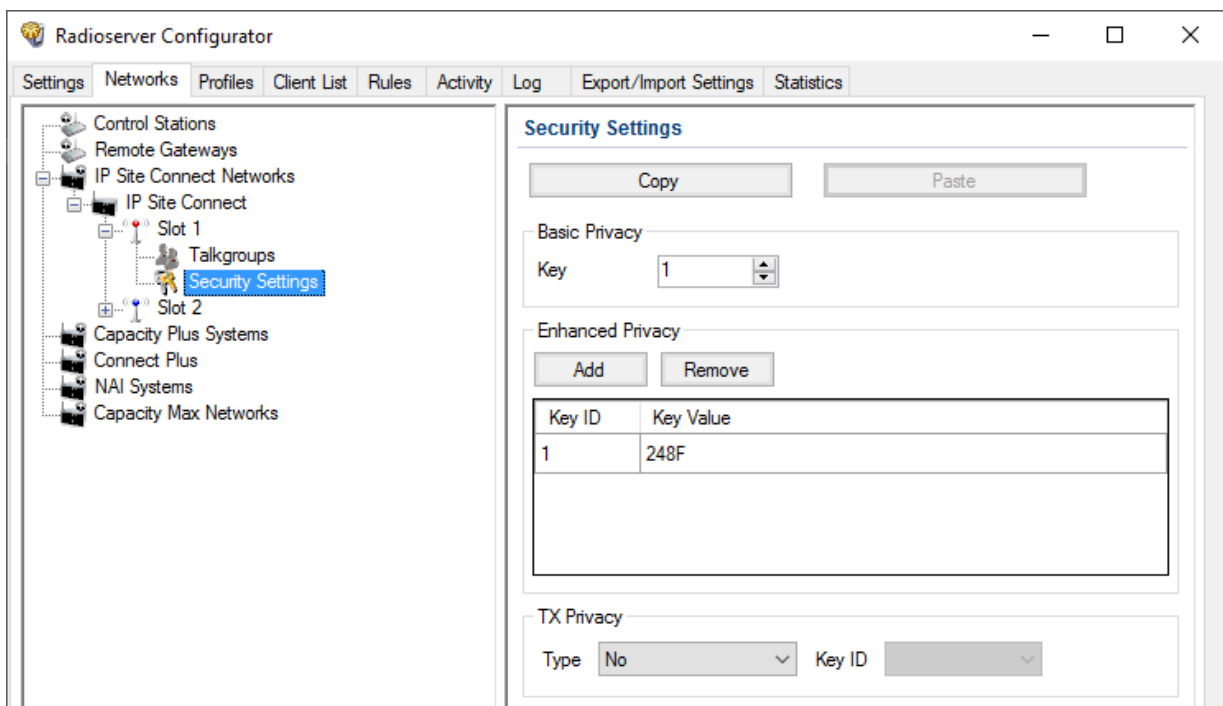

3. Configure the desired encryption type:

To configure basic encryption,

in the **Basic Privacy** area, in the **Key** field, enter the key value.

To configure enhanced encryption,

in the **Enhanced Privacy** area, perform the following actions:

1. Click **Add** to add a new key.
2. In the corresponding row of the table, in the **Key ID** column, double-click the default value, and then type the key ID.

3. In the same row, in the **Key Value** column, double-click the cell, and then type the key value.

4. In the **Tx Privacy** area, configure the encryption of dispatcher transmissions:

To use enhanced encryption,

perform the following actions:

1. From the **Type** list, select *Enhanced*.
2. From the **Key ID** list, select the desired key ID.

To use basic encryption,



from the **Type** list, select *Basic*.

To transmit without encryption,

from the **Type** list, select *No*.

5. To save changes, at the bottom of the SmartPTT Radioserver Configurator window, click **Save Configuration** ().

Postrequisites:

To apply changes immediately, at the bottom of the SmartPTT Radioserver Configurator window, click **Start** () or **Restart** ().

5.2.5 IP Site Connect Configuration (NAI)

Connection to IP Site Connect over NAI requires additional radio devices configuration, MNIS configuration, DDMS configuration, and dispatch software configuration.

Radio Devices Configuration

To support SmartPTT connection, the following actions must be performed:

- Radio IDs must be reserved for the following needs:
 - Dispatch subsystem (SmartPTT) identification.
 - MNIS identification.
 - *(Optional)* Individual dispatcher (operator) identification.
- Peer IDs (Repeater Radio ID) must be reserved for the following needs:
 - SmartPTT identification as a software peer.
 - MNIS identification.
- MNIS Radio ID (**not** SmartPTT Radio ID) must be configured as the ARS ID in all radio codeplugs.
- All radios and repeaters must have the same CAI IDs and CAI Group IDs.
- IP address and UDP port of the master repeater must be obtained.

If you need assistance in the MOTOTRBO devices configuration, contact Motorola Solutions representatives in your region.

MNIS and DDMS Configuration

To configure MNIS and DDMS, the following actions must be performed:

- Dedicated IDs (Radio ID and Peer ID) must be assigned to MNIS.
- MNIS must be connected to the IP Site Connect master repeater.
- *(Optional)* Repeater/RF site coordinates (latitude and longitude) must be configured in MNIS to increase the rate of radio location updates.
- Security keys must be configured in MNIS.
- DDMS address must be configured in MNIS.
- ARS ports must be synchronized in MNIS and DDMS.

If you need assistance in the MOTOTRBO software configuration, contact Motorola Solutions representatives in your region.

SmartPTT Configuration

To configure SmartPTT to work in IP Site Connect, the following actions must be performed:

- Connection to the master repeater must be configured. For details, see [Adding and Editing IP Site Connect over NAI](#).
- SmartPTT Radioserver must be identified on both logical channels (time slots) of the system. For details, see [Configuring SmartPTT Identification](#).
- Talkgroups must be configured for all logical channels (time slots). For details, see [Adding and Editing Talkgroups in IPSC \(NAI\)](#).
- SmartPTT must be connected to the DDMS service. For details, see [Configuring DDMS Connection](#).
- SmartPTT must be connected to the MNIS service. For details, see [Configuring MNIS Data Gateway](#).

If you need assistance in the SmartPTT configuration, submit a request to [SmartPTT Technical Support Center](#).

Network Monitoring

For network monitoring configuration in SmartPTT, the following actions must be performed:

- IP addresses of all repeaters in the system must be obtained.
- IP addresses of all other network devices must be obtained. This includes uninterruptible power supplies (UPS), switches, routers, etc.

5.2.5.1 Adding and Editing IP Site Connect over NAI

Follow the procedure to add or edit connection to IP Site Connect over NAI.

Prerequisites:

- Ensure that SmartPTT has the license for data exchange in the network. For details, see [Viewing License Items](#).
- From codeplugs of repeaters, obtain the following data:
 - IP address and UDP port of a master repeater.
 - Repeater private authentication key.
- If the repeater and radioserver are in different networks controlled by different routers over the router that supports Network Address Translation (NAT), obtain the IP address and UDP port that will be translated to the master repeater IP address and UDP port number.
- *(Optional)* Turn on SmartPTT monitoring. For details, see [Configuring Monitoring Database Connection](#).

Procedure:

1. In SmartPTT Radioserver Configurator, open the **Networks** tab.
2. In the left pane, perform one of the following actions:

To add a new network,

right-click the **NAI Systems** node, point to **Add**, and then select **NAI - IP Site Connect**.

To edit an existing network,

expand the **NAI Systems**, and then click the desired network.

In the right pane, the connection settings appear.

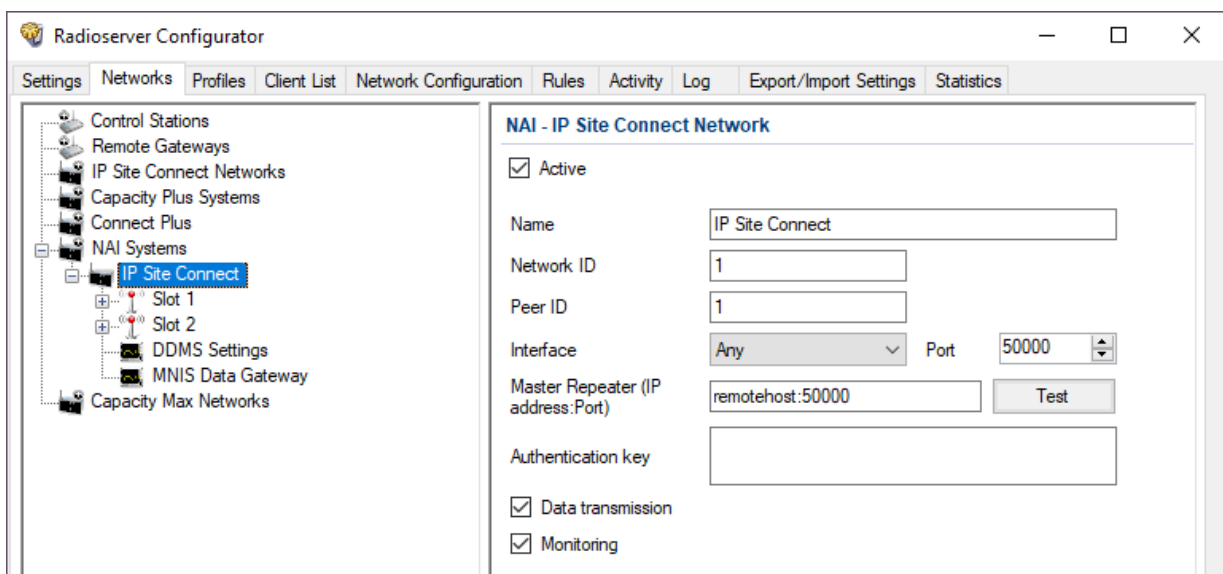

3. Select the **Active** check box to unlock the settings.
4. In the **Name** field, type the network name.
5. Leave the value in the **Network ID** field unchanged.

6. In the **Peer ID** field, type a unique SmartPTT Radioserver identifier as a virtual repeater (Repeater Radio ID).
7. From the **Interface** list, select the radioserver IP address to connect to the master repeater:

To provide the radioserver ability to select IP address, select *Any*.

To use specific IP address, select the desired IP address from the list.

Important



If a radioserver and MNIS are installed on the same computer, use fixed IP address that is different from the MNIS Tunnel IP address (by default, *192.168.56.1*).

Important

If a radio or control station is connected to the computer, use fixed IP address that is different from the radio or control station IP address (by default, *192.168.10.1*).

8. In the **Port** field, enter the radioserver port number that is used for repeater connection.
9. In the **Master Repeater (IP address:Port)** field, type master repeater IP address and port.
10. In the **Authentication Key** field, type the repeater private authentication key.
11. *(Optional)* Click **Test** to check the connection between the radioserver and master repeater.
12. Select the **Data transmission** check box to allow SmartPTT data exchange with MNIS and DDMS services.
13. *(Optional)* Select the **Monitoring** check box to turn on the radio system devices diagnostics.
14. To save changes, at the bottom of the SmartPTT Radioserver Configurator window, click **Save Configuration** ().

Postrequisites:

- Identify radioserver in the system. For details, see [Configuring SmartPTT Identification](#).
- Configure talkgroups in the network. For details, see [Adding and Editing Talkgroups in IPSC \(NAI\)](#).
- If data transmission is allowed, configure DDMS service. For details, see [Configuring DDMS Connection](#).
- If data transmission is allowed, configure MNIS service. For details, see [Configuring MNIS Data Gateway](#).
- To apply changes immediately, at the bottom of the SmartPTT Radioserver Configurator window, click **Start** () or **Restart** ().

5.2.5.2 Configuring SmartPTT Identification

Follow the procedure to configure SmartPTT identification on a slot of the IP Site Connect network.

Prerequisites:

- Set the network settings. For details, see [Adding and Editing IP Site Connect over NAI](#).
- From radio codeplugs, obtain the following data:
 - CAI and CAI group values.

- Outgoing transmissions interrupt settings.
- CSBK data settings (active or inactive).
- From the MNIS configuration file, obtain information on site coordinates (configured or not).

Procedure:

1. In SmartPTT Radioserver Configurator, open the **Networks** tab.
2. In the left pane, expand **NAI Systems** → **<network name>**.
3. Select the desired slot for identification:

To identify SmartPTT on the first time slot, click the first (upper) node of the slot.

To identify SmartPTT on the second time slot, click the second (lower) node of the slot.

To identify SmartPTT on a local slot, click the node of the desired local slot.

In the right pane, the slot settings appear.

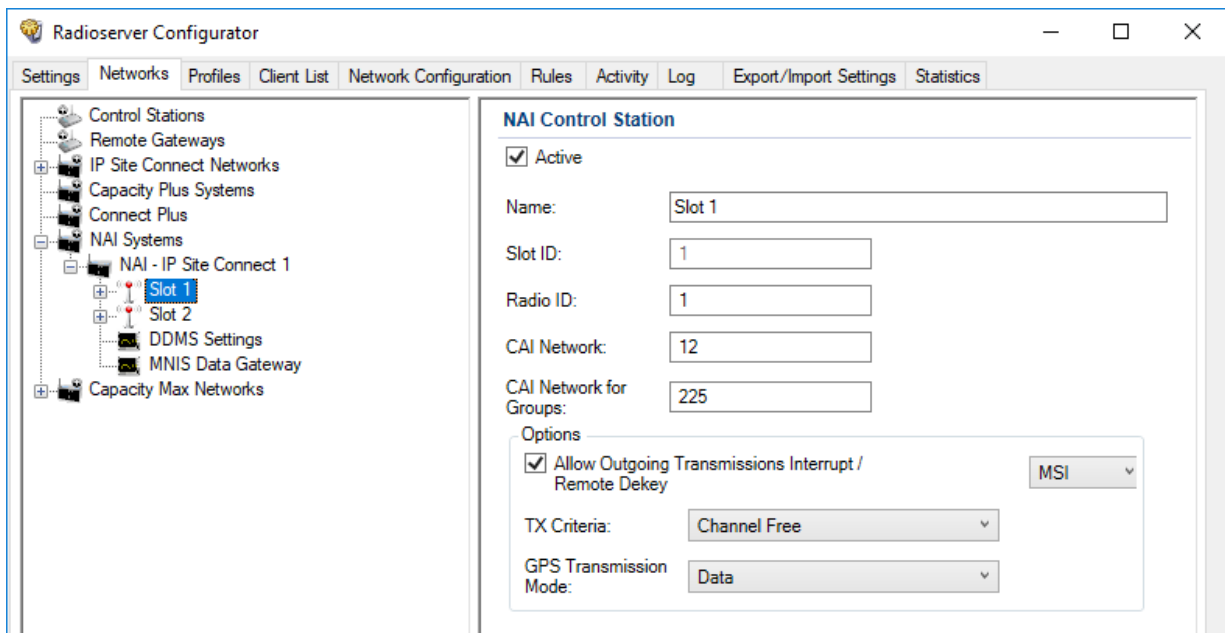

4. In the right pane, select the **Active** check box.
5. In the **Name** field, type the slot name.
6. Type the SmartPTT Radioserver identification parameters:
 - a. In the **Radio ID** field, type the radio ID that is reserved for SmartPTT Radioserver.
 - b. In the **CAI Network** field, type the CAI ID.
 - c. In the **CAI Network for Groups** field, type the CAI Group ID.
7. Configure the possibility to interrupt voice transmissions from a dispatcher with voice transmissions from a radio:
 - a. Select the **Allow Outgoing Transmissions Interrupt / Remote Dekey** check box.

b. Next to the check box, from the list, select the interruption protocol:

To use the protocol developed by Motorola Solutions,	select <i>MSI</i> .
--	---------------------

To use the protocol included in the DMR digital communication standard,	select <i>DMR</i> .
---	---------------------

Important

The **Allow Outgoing Transmissions Interrupt / Remote Dekey** parameter does not affect the ability of emergency transmissions to interrupt outgoing transmissions from a dispatcher.

8. From the **TX Criteria** list, select one of the following options:

If the call initiator must transmit only when no other transmissions are detected over the radio channel,	select <i>Channel Free</i> .
---	------------------------------

If the call initiator must interrupt another participant of the radio network in accordance with the selected MSI or DMR protocol,	select <i>Tx Interrupt</i> .
--	------------------------------

If the call initiator must completely ignore other transmissions over the radio channel,	select <i>Always</i> .
--	------------------------

9. From the **GPS Transmission Mode** list, select one of the following options:



If CSBK data is used in the radio system and site coordinates are configured in MNIS,	select <i>Enhanced CSBK</i> .
---	-------------------------------

If CSBK data is used in the radio system but site coordinates are not configured in MNIS,	select <i>CSBK</i> .
--	----------------------

If CSBK data is not used in the radio system or outdoor positioning service is used together with indoor positioning service,	select <i>Data</i> .
--	----------------------

10. To save changes, at the bottom of the SmartPTT Radioserver Configurator window, click **Save Configuration** ().

Postrequisites:

- Configure talkgroups. For details, see [Adding and Editing Talkgroups in IPSC \(NAI\)](#).
- To apply changes immediately, at the bottom of the SmartPTT Radioserver Configurator window, click **Start** () or **Restart** ().

5.2.5.3 Adding and Editing Talkgroups in IPSC (NAI)

Follow the procedure to add or edit talkgroups on the selected slot.

Prerequisites:

- Set the selected slot settings. For details, see [Configuring SmartPTT Identification](#).
- From repeater codeplugs, obtain talkgroup IDs.

Procedure:

1. In SmartPTT Radioserver Configurator, open the **Networks** tab.
2. In the left pane, expand **NAI Systems** → <network name> → <slot name>, and then select **Talkgroups**.

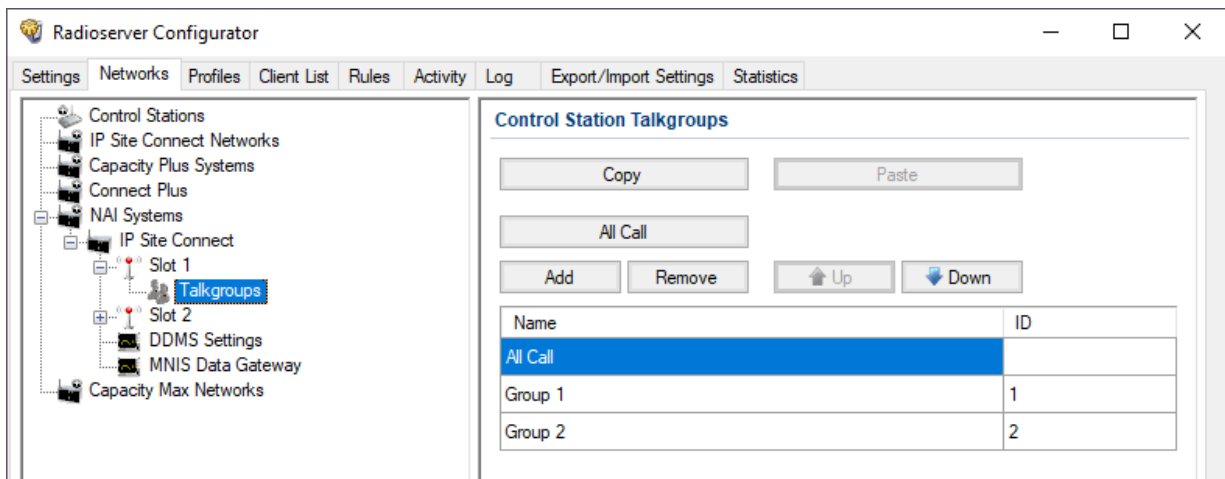

3. In the right pane, perform one of the following actions:

To add a new talkgroup,



click **Add**.

To edit an existing entry,

proceed to the next step of the procedure.

4. In the table, in the desired entry, perform the following actions:
 - a. In the **Name** column, double-click the current talkgroup name, and then type the desired name.
 - b. In the **ID** column, double-click the current talkgroup ID, and then type the desired ID.
5. (Optional) Using **Up** and **Down** buttons, reorder entries in the table.
6. To save changes, at the bottom of the SmartPTT Radioserver Configurator window, click **Save Configuration** ().

Postrequisites:

- To apply changes immediately, at the bottom of the SmartPTT Radioserver Configurator window, click **Start** () or **Restart** ().
- Duplicate the list of groups for other slots of the system. For details, see [Group Duplication](#).

5.3 Capacity Plus

Capacity Plus is a family of digital trunked radio systems by Motorola Solutions. The family includes single-site and multisite systems. Multisite systems may be referred to as Linked Capacity Plus or Capacity Plus Multi-Site.

In SmartPTT, single-site and multisite systems are configured differently. The current section describes the single-site solution (Capacity Plus). For information on the multisite system, see [Linked Capacity Plus](#).

MOTOTRBO™ Capacity Plus is a digital (DMR) trunked radio system. It is a single-site system with high channel capacity (up to 12 simultaneous voice calls). This is achieved by the use of multiple repeaters installed on the site. Each repeater is configured to the unique duplex channel. For details, see [MOTOTRBO™ Capacity Plus](#) on the Motorola Solutions website.

SmartPTT is able to connect to multiple Capacity Plus systems at a time. If bridging is configured between those systems, SmartPTT will provide increased RF coverage. The size of the zone will be proportional to the number of the bridged Capacity Plus systems.

SmartPTT supports the following interfaces for Capacity Plus connection:

- Hybrid interface (involves control stations). For details, see [Capacity Plus over Hybrid Interface](#).
- Network Application Interface (NAI). For details, see [Capacity Plus over NAI](#).

5.3.1 Capacity Plus over Hybrid Interface

Hybrid interface determines the following type of SmartPTT connection to Capacity Plus:

- Wireline IP connection to the repeater system for voice and data reception.
- Control station connection for voice and data transmission.

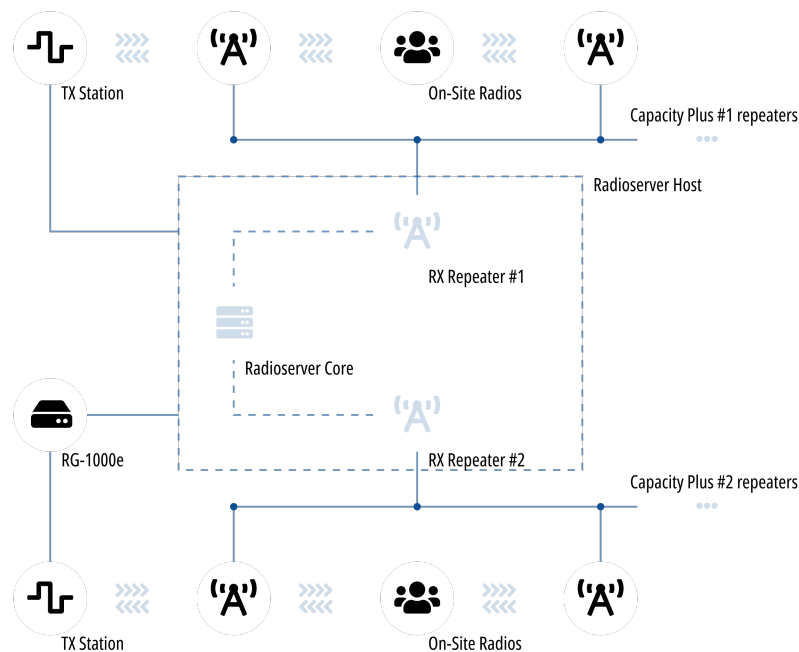

In each hybrid interface, a dedicated control station is used. In this manual, it is named “TX station”. In SmartPTT Radioserver Configurator, TX station is configured as part of the Capacity Plus connection, apart from regular control stations.

TX station can be connected to SmartPTT Radioserver in one of the following ways:

- Locally (to the USB and audio ports of the SmartPTT Radioserver computer).
- Remotely (over the RG-1000e radio gateway).

Only RG-1000e is supported in SmartPTT as a radio gateway. For information on it and its capabilities, see [SmartPTT RG-1000e](#) on the SmartPTT website.

5.3.2 Capacity Plus over NAI

Network Application Interface (NAI) is a dedicated radio system interface for SmartPTT. It requires to use the following additional software:

- MOTOTRBO Network Interface Service (MNIS) provides data communication between the radio system and SmartPTT.
- Device Discovery and Mobility Service (DDMS) provides the radio presence (ARS) information to SmartPTT.

NAI is recommended to use by Motorola Solutions.

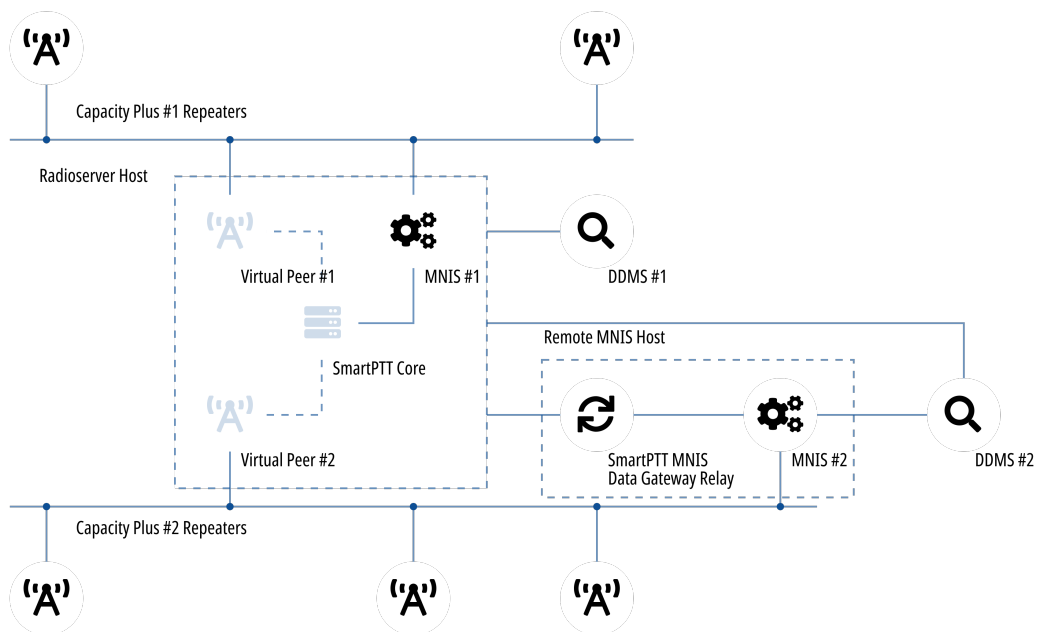

NAI provides the following features to SmartPTT users:

- High rate of the radio location updates (up to 8 times/min).
- Current radio user identification.

Using NAI for Capacity Plus connection required SmartPTT to have the corresponding license.

NAI does **not** provide the following features to SmartPTT:

- Voice calls
- Emergency alarms and calls

- Radio commands

To receive voice calls, hybrid interface must be used. For details, see [Capacity Plus over Hybrid Interface](#).

5.3.3 SmartPTT Features in Capacity Plus

Capacity Plus provides SmartPTT with access to the following features:

- Information on radio presence in the network (ARS).
- Radio user identification.
- Radio location updates (includes revert channel support).
- Text messaging and job ticketing.
- Telemetry and remote control over radios.

For hybrid interface, Capacity Plus provides the following features to SmartPTT:

- Voice call reception and initiation (includes group calls and private calls).
- Emergency alarms and calls.
- Radio commands.

Important

Hybrid interface features are unavailable over NAI.

SmartPTT provides the following features for Capacity Plus users:

- Simultaneous access to multiple systems.
- Integration with other radio systems using cross patches, bridging, and conference calls (hybrid interface only).
- Telephone interconnect over SIP trunk (hybrid interface only).
- Event logging and voice recording (voice recording is available only over the hybrid interface connection).
- Per-console and system-wide rules.
- Availability for Web Client users, SmartPTT Mobile users, and third-party applications.

For network monitoring purposes, SmartPTT provides the following features:

- Network device monitoring over SNMP (includes control stations).
- Integral radio channel monitoring (also referred to as “air monitoring”).
- Repeater control over RDAC.
- Network topology visualization and update.

NOTE

SmartPTT does **not** show on-site/fielded radios on topology diagrams.

- Statistical information gathering (system performance, alarm statistics), reports generation.

5.3.4 Capacity Plus Configuration (Hybrid)

Hybrid interface implementation for SmartPTT connection to Capacity Plus requires additional radio devices configuration, TX station configuration, and then dispatch software configuration.

Planning Requirements

To support SmartPTT connection, radio system must comply with the following requirements:

- All radios and repeater must have equal CAI and CAI Group IDs.
- All radios (including TX stations) must have equal hangtime durations for group calls, private calls, and emergency calls.
- All radios must have equal ARS and GNSS IDs. In each radio codeplug, ARS ID must be equal to the GNSS ID.

NOTE

The ID will be used as an ID of the dispatch subsystem.

- If radioserver and master repeater are “hidden” from each other behind a router, the Network Address Translation (NAT) feature must be available in the router.
- If radioserver and radio gateway are “hidden” from each other behind a router, the Network Address Translation (NAT) feature must be available in the router.
- Security keys must be known to those who will configure SmartPTT Radioserver since MOTOTRBO hides them after the key value is entered and does **not** provide tools to view them.

TX Station Configuration

To configure TX stations that will be used to transmit in Capacity Plus, the following actions must be performed:

- CAI ID and CAI Group ID must be the same as in radios and repeaters.
- Each TX station must have digital channels configured to be used in the trunked radio system.
- For each channel, a different default talkgroup or All Call must be configured.
- For each channel, a specific security key must be configured (if required).

NOTE

SmartPTT does not allow transmission initiation to the same talkgroup or radio using different security keys.

- *(Optional)* One of multiple TX stations must have the Radio ID equal to that of the dispatch subsystem.

If you need assistance in the TX station configuration, submit a request to the [SmartPTT Technical Support Center](#).

Network Devices Configuration

Network equipment modification is required only if radioserver, master repeater, and/or radio gateways are hidden from each other behind routers. In this case, network address translation must be configured for the following system elements:

- Radioserver and the master repeater of the system.

- Radioserver and radio gateways used to connect TX station.

If you need assistance in the devices configuration, submit a request to the [SmartPTT Technical Support Center](#).

SmartPTT Configuration

For voice and data reception, the following actions must be performed:

- Connection to the master repeater must be configured. For details, see [Configuring Capacity Plus Connection](#).
- SmartPTT Radioserver must be identified in the radio system. For details, see [Configuring RX Interface](#).
- Talkgroups and All Calls must be configured. For details, see [Configuring Incoming Group Calls in Capacity Plus](#).
- Security keys must be configured in SmartPTT. For details, see [Configuring Voice Decryption](#).

For voice and data transmission over the locally connected TX station, the following actions must be performed:

- TX station must be connected to the SmartPTT using digital-and-analog interface. For details, see [Configuring Local TX Station Connection](#).
- Talkgroups and All Calls must be duplicated from the voice and data reception settings. For details, see [Configuring Local TX Station Groups](#).
- Audio processing must be configured for TX station. For details, see [Configuring Local TX Station Audio](#).

For information on remote TX stations, see [Remote TX Station Configuration](#).

Network Monitoring

For Capacity Plus network monitoring, the following actions must be performed:

- IP addresses of all repeaters must be obtained.
- IP addresses of all radio gateways must be obtained.
- IP addresses of all network devices must be obtained. This includes uninterruptible power supplies (UPS), switches, routers, etc.

5.3.4.1 Configuring Capacity Plus Connection

Follow the procedure to configure radio system connection using the hybrid interface.

Prerequisites:

- Ensure that the SmartPTT license allows direct repeater connection. For details, see [Viewing License Items](#).
- From repeater codeplugs, obtain the following data:
 - IP address and UDP port of the master repeater.
 - Repeater private authentication key.
- From radio codeplugs, obtain hangtime durations for group, private, and emergency calls.
- If the radioserver and master repeater are “hidden” from each other behind a router, obtain router IP address and UDP port that are resolved to the master repeater IP address and port number.

Procedure:

1. In SmartPTT Radioserver Configurator, open the **Networks** tab.
2. In the left pane, perform one of the following actions:

To add a new connection,

right-click the **Capacity Plus Systems** node, and then click **Add**.

To edit an existing connection,

expand **Capacity Plus Systems**, and then click the desired node.

To remove an existing connection,

perform the following actions:

1. Expand **Capacity Plus Systems**.
2. Right-click the desired node, and then click **Delete**.
3. Proceed to [step 11](#).

Connection settings appear in the right pane.

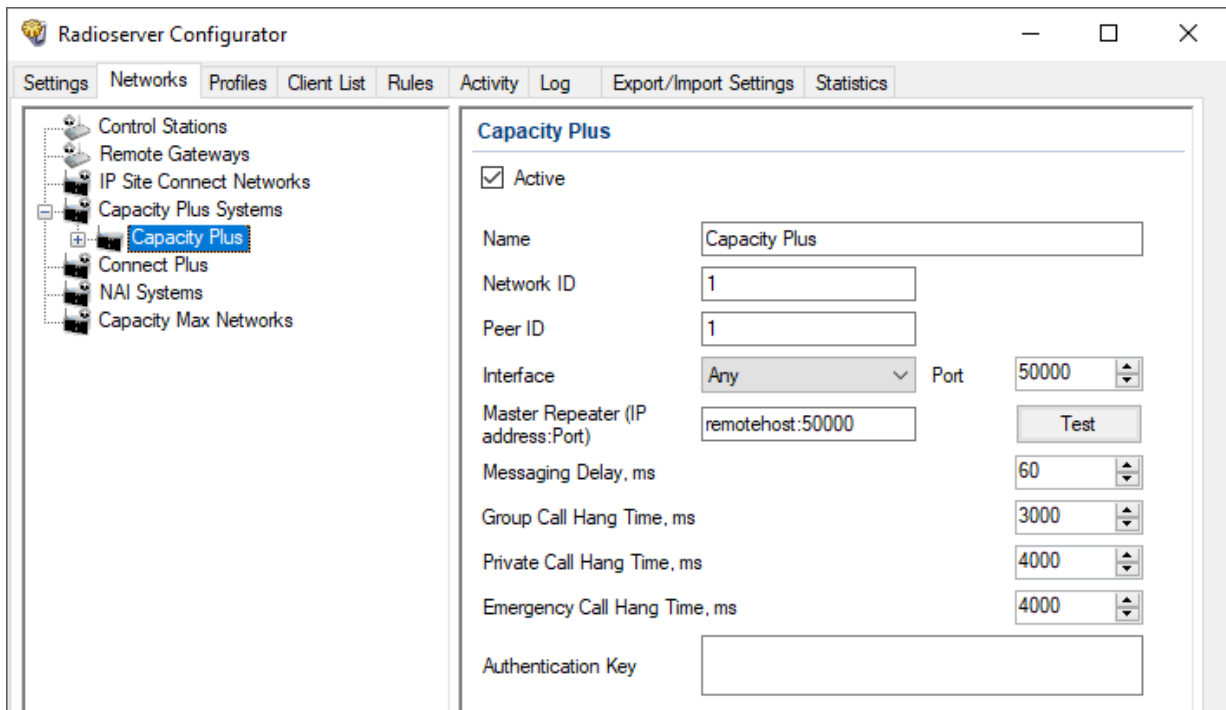

3. In the right pane, select the **Active** check box.
4. In the **Name** field, type the connection name.

5. Leave the value of the **Network ID** parameter unchanged.
6. Configure the master repeater connection:
 - a. In the **Peer ID** field, type the unique Repeater Radio ID that will represent radioserver in the system.
 - b. From the **Interface** list, select one of the following options:

To allow any IP address to be used for connection, select *Any*.



To use fixed radioserver IP address, select the desired IP address.

Important

Use fixed IP addresses if radios are connected to the radioserver computer, or control stations are connected to the computer, or MNIS is installed on the computer.

- c. In the **Port** field, enter the radioserver port that will be used for the repeater connection.
 - d. In the **Master Repeater (IP address:Port)** field, type the repeater IP address and UDP port number (considering the potential NAT usage). Input format is <IP address in dot-decimal notation>:<UDP port>.
 - e. In the **Authentication Key** field, type the restricted access code.
 - f. *(Optional)* Click **Test** to test the repeater connection.
7. In the **Messaging Delay, ms** field, enter the network delay between repeaters (in milliseconds).
8. In the **Group Call Hang Time, ms** field, enter the duration of the group call hangtime (in milliseconds).
9. In the **Private Call Hang Time, ms** field, enter the duration of the private call hangtime (in milliseconds).
10. In the **Emergency Call Hang Time, ms** field, enter the duration of the emergency call hangtime (in milliseconds).
11. To save changes, at the bottom of the SmartPTT Radioserver Configurator window, click **Save Configuration** ().

Postrequisites:

- Configure SmartPTT Receive (RX) interface. For details, see [Configuring RX Interface](#).
- Configure TX stations for voice and data transmission to the radio network:
 - For information on local TX stations, see [Configuring Local TX Station Connection](#).
 - For information on remote TX stations, see [Configuring Remote TX Station Connection](#).
- To apply changes immediately, at the bottom of the SmartPTT Radioserver Configurator window, click **Start** () or **Restart** ().

5.3.4.2 Configuring RX Interface

Follow the procedure to configure SmartPTT identification in the radio network.

Prerequisites:

- From radio codeplugs, obtain radio network ID (CAI) and radio network group ID (CAI Group).
- Determine radio ID that will be assigned to the radioserver.
- Configure SmartPTT connection to Capacity Plus. For details, see [Configuring Capacity Plus Connection](#).

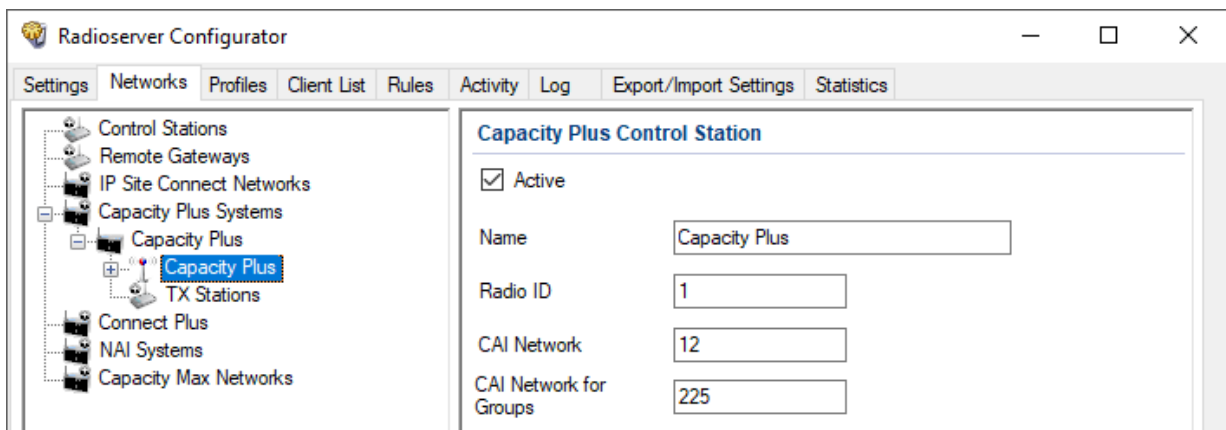

Procedure:

1. In SmartPTT Radioserver Configurator, open the **Networks** tab.
2. In the left pane, expand **Capacity Plus Systems** → <system name>, and then click <station name>. The identification settings appear in the right pane.



3. In the right pane, select the **Active** check box.
4. In the **Name** field, type the network name that will be used in the SmartPTT Dispatcher application.
5. In the **Radio ID** field, type the unique radio ID allocated to the radioserver.
6. In the **CAI Network** field, type the radio network ID.
7. In the **CAI Network for Groups** field, type the radio network group ID.
8. To save changes, at the bottom of the SmartPTT Radioserver Configurator window, click **Save Configuration** ().

Postrequisites:

- Configure group calls. For details, see [Configuring Incoming Group Calls in Capacity Plus](#).
- Configure security keys for voice decryption. For details, see [Configuring Voice Decryption](#).
- Configure TX stations for voice and data transmission in radio network:
 - For details, see local TX stations, see [Configuring Local TX Station Connection](#).
 - For details, see remote TX stations, see [Configuring Remote TX Station Connection](#).
- To apply changes immediately, at the bottom of the SmartPTT Radioserver Configurator window, click **Start** () or **Restart** ().

5.3.4.3 Configuring Incoming Group Calls in Capacity Plus

Follow the procedure to allow incoming group calls (including All Calls) from the radio network.

Prerequisites:

- Configure SmartPTT identification in the network. For details, see [Configuring RX Interface](#).
- From radio codeplugs, obtain talkgroup IDs assigned to Capacity Plus channels.

Procedure:

1. In SmartPTT Radioserver Configurator, open the **Networks** tab.
2. In the left pane, expand **Capacity Plus Systems** → <system name> → <station name>, and then click **Talkgroups**.

The list of groups appears in the right pane.

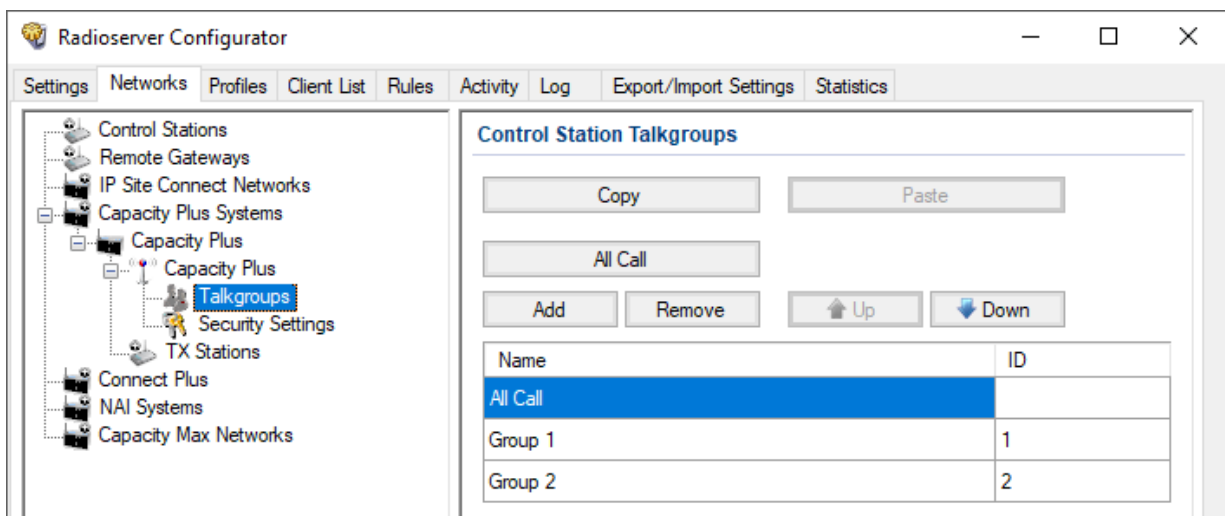

3. In the right pane, perform one of the following actions:

To add a new talkgroup,

click **Add**.

To add an All Call,

click **All Call**.

NOTE

In Capacity Plus, only one All Call is allowed.

To edit an existing entry,

proceed to the next step of the procedure.

To delete an existing entry,

perform the following actions:

1. In the table, click the desired entry.
2. Click **Delete**.
3. Proceed to [step 6](#).

4. In the desired entry of the table, perform the following actions:



- a. In the **Name** column, double-click the current name, and then type the desired name.
- b. In the **ID** column, double-click the current talkgroup ID, and then type the desired ID.

NOTE

SmartPTT does **not** show the All Call ID and does **not** allow its editing.

5. (Optional) Using **Up** and **Down** buttons, reorder entries in the table.
6. To save changes, at the bottom of the SmartPTT Radioserver Configurator window, click **Save Configuration** ().

Postrequisites:

- To apply changes immediately, at the bottom of the SmartPTT Radioserver Configurator window, click **Start** () or **Restart** ().
- (Optional) Configure multigroups. For details, see [Managing Multigroups](#).

5.3.4.4 Configuring Voice Decryption

Follow the procedure to add security keys that are used for voice decryption.

Prerequisites:

Obtain security key IDs and values that are used by radios.

Important

MOTOTRBO software does **not** show security key values after they were added to the codeplug.

Procedure:

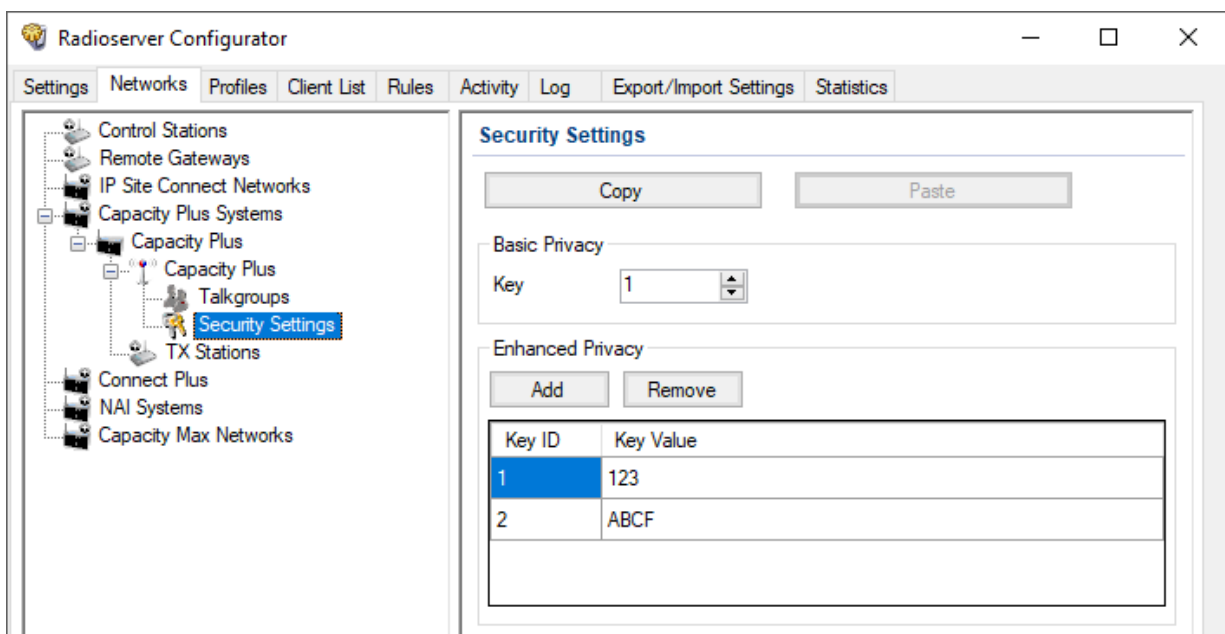

1. In SmartPTT Radioserver Configurator, open the **Networks** tab.
2. In the left pane, expand **Capacity Plus Systems** → **<system name>** → **<station name>**, and then click **Security Settings**.



3. Configure the desired security keys:

-
- | | |
|----------------------------------|---|
| To configure basic security key, | in the Basic Privacy area, in the Key field, enter the key value. |
|----------------------------------|---|
-
- | | |
|-------------------------------------|--|
| To add a new enhanced security key, | perform the following actions: <ol style="list-style-type: none">1. In the Enhanced Privacy area, click Add.2. In the new table entry, in the Key ID column, double-click the current ID, and then type the desired ID.3. In the same entry, in the Key Value column, double-click the current value, and then type the desired value. |
|-------------------------------------|--|
-
- | | |
|-----------------------------------|---|
| To edit an existing security key, | perform the following actions: <ol style="list-style-type: none">1. In the Enhanced Privacy area, in the desired table entry, in the Key ID column, double-click the current ID, and then type the desired ID.2. In the same entry, in the Key Value column, double-click the current value, and then type the desired value. |
|-----------------------------------|---|
-
- | | |
|-------------------------------------|---|
| To remove an existing security key, | perform the following actions: <ol style="list-style-type: none">1. In the Enhanced Privacy area, click the desired entry.2. Click Remove. |
|-------------------------------------|---|
-
4. To save changes, at the bottom of the SmartPTT Radioserver Configurator window, click **Save Configuration** ().

Postrequisites:

To apply changes immediately, at the bottom of the SmartPTT Radioserver Configurator window, click **Start** () or **Restart** (.

5.3.4.5 Configuring Local TX Station Connection

Follow the procedure to configure the local TX station connection that is required for outgoing transmission in Capacity Plus.

Prerequisites:

- Connect the TX station to the radioserver computer using a special cable provided by Elcomplus LLC for local TX stations.
- From the TX station codeplug, obtain the following information:
 - Radio ID.
 - Ports that are allocated for various data transmission.
 - Interrupt settings.

Procedure:

1. In SmartPTT Radioserver Configurator, open the **Networks** tab.
2. In the left pane, expand **Capacity Plus Systems** → <system name>.
3. Access the desired TX station:

To add a new connection,

right-click the **TX Stations** node, point to **Add**, and then select **MOTOTRBO Control Station**.

To edit an existing connection,

expand **TX Stations**, and then click the current node.

To delete an existing connection,

perform the following actions:

1. Expand **TX Stations**.
 2. Right-click the current node, and then select **Delete**.
 3. Proceed to [step 11](#).
-

TX station connection parameters appear in the right pane.

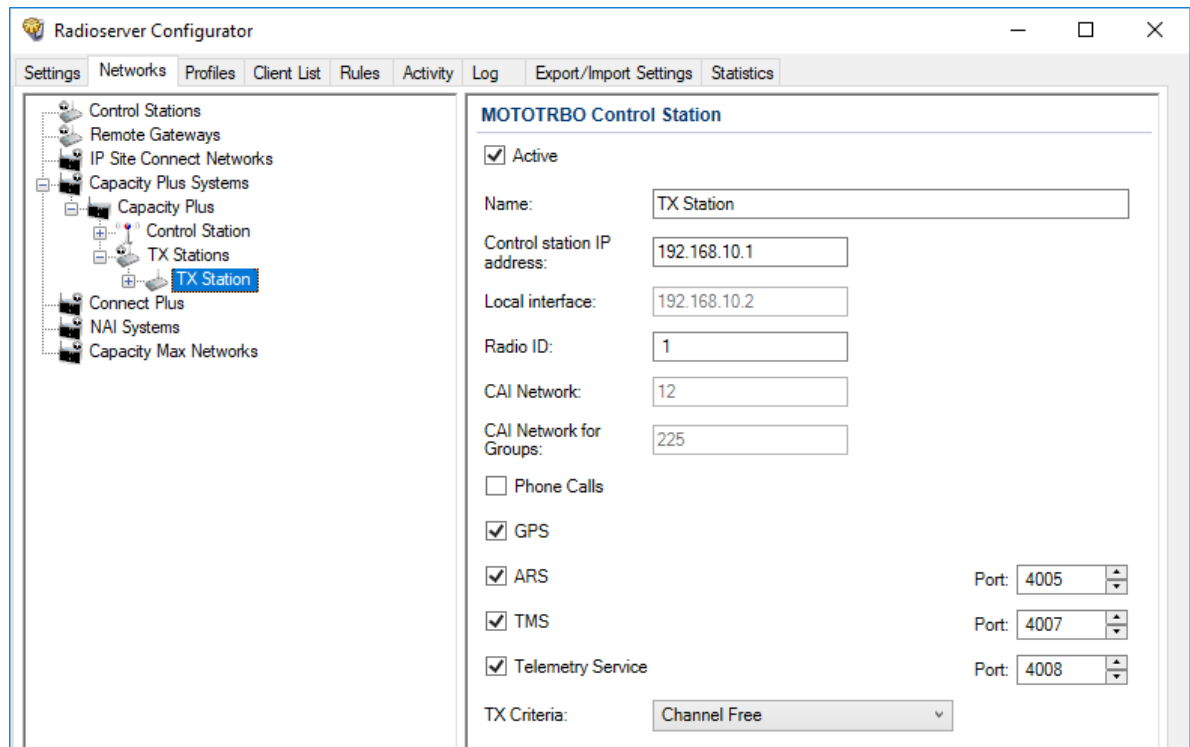

4. In the right pane, select the **Active** check box.
5. In the **Name** field, type the TX station name.
6. In the **Control station IP address** field, type the IP address of the radioserver computer interface associated with the connected TX station.
7. In the **Radio ID** field, type the Radio ID of the TX station that is configured in its codeplug.
8. Select the **Phone Calls** check box to allow phone calls initiation over the TX station.

Important

When a phone call is initiated in the phone system, TX station performs a regular radio call in the radio network.

9. Allow various data transmission over the TX station:

To request current radio locations,

select the **GPS** check box.

To request radio registration updates,

perform the following actions:

1. Select the **ARS** check box.
2. Next to the check box, in the **Port** field, enter the station port number to which radioserver will send requests.

To send text messages and job tickets,

perform the following actions:

1. Select the **TMS** check box.

2. Next to the check box, in the **Port** field, enter the station port number to which radioserver will send text messages and job tickets.

To send the remote control commands to devices connected over the fielded radios,

perform the following actions:

1. Select the **Telemetry Service** check box.
2. Next to the check box, in the **Port** field, enter the station port number to which radioserver will send remote control commands.

10. From the **TX Criteria** list, select the proper option:

If TX station is configured to transmit when no other transmissions and/or noise is detected on the channel,

select *Channel Free*.

If TX station is configured to interrupt other transmissions,

select *Tx Interrupt*.

If TX station is configured to ignore other transmissions on the channel,



select *Always*.

Important

SmartPTT does **not** support color codes.

11. To save changes, at the bottom of the SmartPTT Radioserver Configurator window, click **Save Configuration** ().

Postrequisites:

- Configure group calls. For details, see [Configuring Local TX Station Groups](#).
- Configure audio outputs. For details, see [Configuring Local TX Station Audio](#).
- To apply changes immediately, at the bottom of the SmartPTT Radioserver Configurator window, click **Start** () or **Restart** ().

5.3.4.6 Configuring Local TX Station Groups

Follow the procedure to configure talkgroups and All Calls that will be available to dispatchers on the TX station.

Prerequisites:

- Obtain talkgroup IDs configured for voice and data reception. For details, see [Configuring Incoming Group Calls in Capacity Plus](#).
- From TX station codeplug, for each talkgroup (and All Call), obtain zone ID and channel ID to which the talkgroup (and All Call) is assigned.
- Connect the local TX station. For details, see [Configuring Local TX Station Connection](#).

Procedure:

1. In SmartPTT Radioserver Configurator, open the **Networks** tab.
2. In the left pane, expand **Capacity Plus Systems** → **<system name>** → **TX Stations** → **<station name>**, and then click **Talkgroups / Channels**.

The list of groups appears in the right pane.

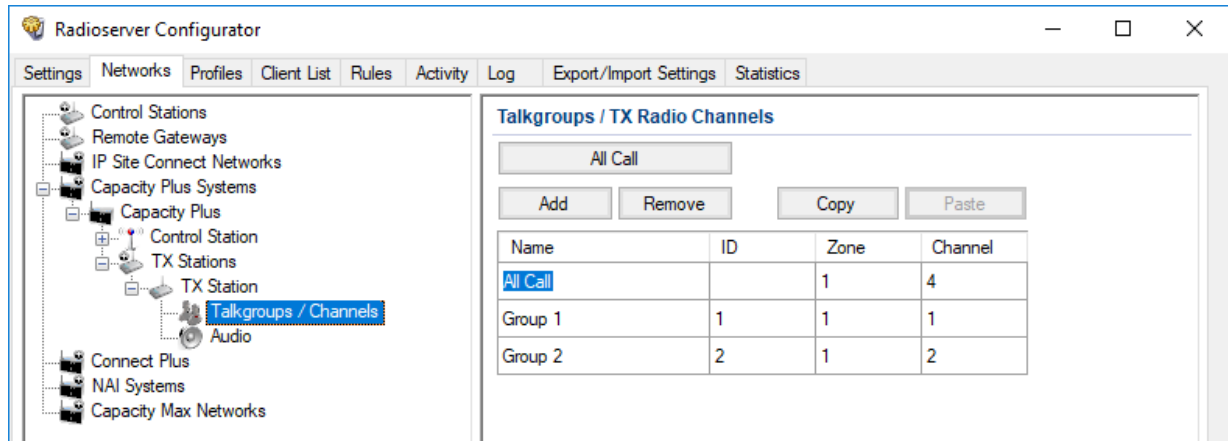

3. In the right pane, perform one of the following actions:

To add a new talkgroup,

click **Add**.

To add All Call,

click **All Call**.

To edit an existing entry,

proceed to the next step of the procedure.

To remove an existing entry,

perform the following actions:

1. In the list of groups, click the required entry.
2. Click **Remove**.
3. Proceed to [step 5](#).

4. In the desired table entry, perform the following actions:

- a. In the **Name** column, double-click the current name, and then type the desired name.
- b. In the **ID** column, double-click the current ID, and then type the desired ID.

NOTE

SmartPTT does **not** show All Call ID and does **not** allow its editing.

- c. In the **Zone** column, double-click the current zone ID, and then type the desired ID.
- d. In the **Channel** column, double-click the current channel ID, and then type the desired ID.

5. To save changes, at the bottom of the SmartPTT Radioserver Configurator window, click **Save Configuration** ().

Postrequisites:

- To apply changes immediately, at the bottom of the SmartPTT Radioserver Configurator window, click **Start** (▶) or **Restart** (▶).
- Copy the configured groups to other (local and remote) TX stations. For details, see [Duplicating TX Station Groups](#).

5.3.4.7 Configuring Local TX Station Audio

Follow the procedure to configure audio output (microphone port) of the radioserver computer that will be used for outgoing transmissions over TX station.

Prerequisites:

- Configure audio outputs of the computer.
- Connect the local TX station. For details, see [Configuring Local TX Station Connection](#).

Procedure:

1. In SmartPTT Radioserver Configurator, open the **Networks** tab.
2. In the left pane, expand **Capacity Plus Systems** → <system name> → **TX Stations** → <station name>, and then click **Audio**.

Audio output information appears in the right pane.

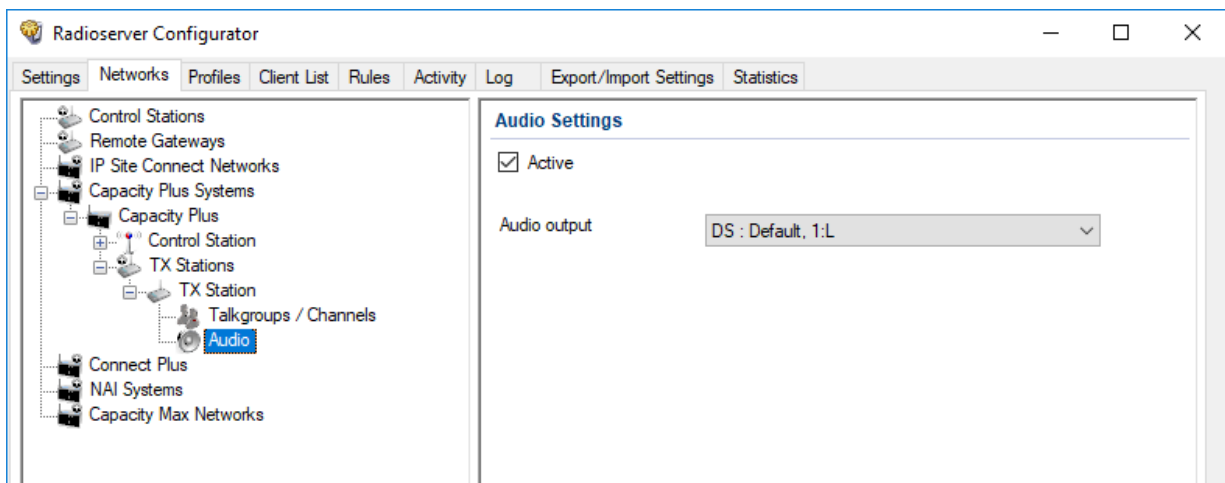

3. In the right pane, select the **Active** check box.
4. From the **Audio output** list, select computer audio output that is allocated for the local TX station.
5. To save changes, at the bottom of the SmartPTT Radioserver Configurator window, click **Save Configuration** (📄).

Postrequisites:

To apply changes immediately, at the bottom of the SmartPTT Radioserver Configurator window, click **Start** (▶) or **Restart** (▶).

5.3.4.8 Remote TX Station Configuration

Remote TX stations are control stations used in SmartPTT for voice and data transmission in Capacity Plus and which are accessible over the RG-1000e radio gateway. For the connection, the following actions must be performed:

- Radio gateway must be properly configured. For details, see “RG-1000e Configuration” [below](#).
- SmartPTT must be properly configured. For details, see “SmartPTT Configuration” [below](#).

RG-1000e Configuration

To configure the radio gateway to support TX station, the following actions must be performed:

- TX station must be connected to the gateway using Elcomplus LLC cable.
- Power supply and grounding must be configured correctly for control station gateway.

WARNING

Power connection may result in the unintended personnel injury or equipment damage. The connection must be performed by a qualified engineer who has the corresponding license.

- In the gateway configuration file, the correct connection mode must be configured:
 - MOTOTRBO radio connection.
 - Control station connection.
- Gateway IP channel association with a physical radio port must be configured.
- Other IP channels association with this radio port must be disabled (except for the channel providing remote configuration of the gateway).
- *(Optional)* Audio gain/attenuation must be configured on the radio port.

For information on the gateway settings, see the corresponding documentation:

- RG-1000e Remote Gateway User Guide
- CPS RG-1000e User Guide

SmartPTT Configuration

To configure SmartPTT for voice and data transmission over the remote TX station, the following actions must be performed:

- SmartPTT connection to the TX station must be configured. For details, see [Configuring Remote TX Station Connection](#).
- TX station talkgroups and All Call must be configured. For details, see [Configuring Remote TX Station Groups](#).
- Voice encoding must be configured. For details, see [Configuring Remote TX Station Audio](#).

5.3.4.8.1 Configuring Remote TX Station Connection

Follow the procedure to add a new or edit an existing connection to the remote TX station.

Prerequisites:

- Ensure that SmartPTT license allows remote control stations access. For details, see [Viewing License Items](#).
- From the control station codeplug, obtain the following information:
 - Radio ID, CAI ID, and CAI Group ID.
 - Control station ports used to receive and transmit various data types.
 - Transmit interruption parameters.
 - Location provision settings that depend on data transmission settings on channel.
- From the radio gateway codeplug, receive the IP address and port number configured for the desired control station.
- Determine the control station connection mode.
- *(Optional)* Determine SmartPTT Radioserver host ports that will be used to receive different data types from the control station.

Procedure:

1. In SmartPTT Radioserver Configurator, open the **Networks** tab.
2. In the left pane, expand **Capacity Plus Systems** → **<system name>**.
3. Access the required TX station:

To add a new TX station with a new gateway,

perform the following actions:

1. In the left pane, right-click **TX Stations**, point to **Add**, and then select **Remote Gateway**.
2. In the right pane, select the **Active** check box.
3. *(Optional)* In the **Name** field, type the gateway name.
4. Right-click **<Gateway Name>**, point to **Add**, and then select **Remote MOTOTRBO Control Station**.

To add a new TX station to the existing gateway,

perform the following actions:

1. In the left pane, expand **TX Stations**.
 2. Right-click **<Gateway Name>**, point to **Add**, and then select **Remote MOTOTRBO Control Station**.
-

To edit an existing TX station connection,

in the left pane, expand **TX Stations** → **<Gateway Name>**, and then click the desired station.

The control station parameters appear in the right pane.

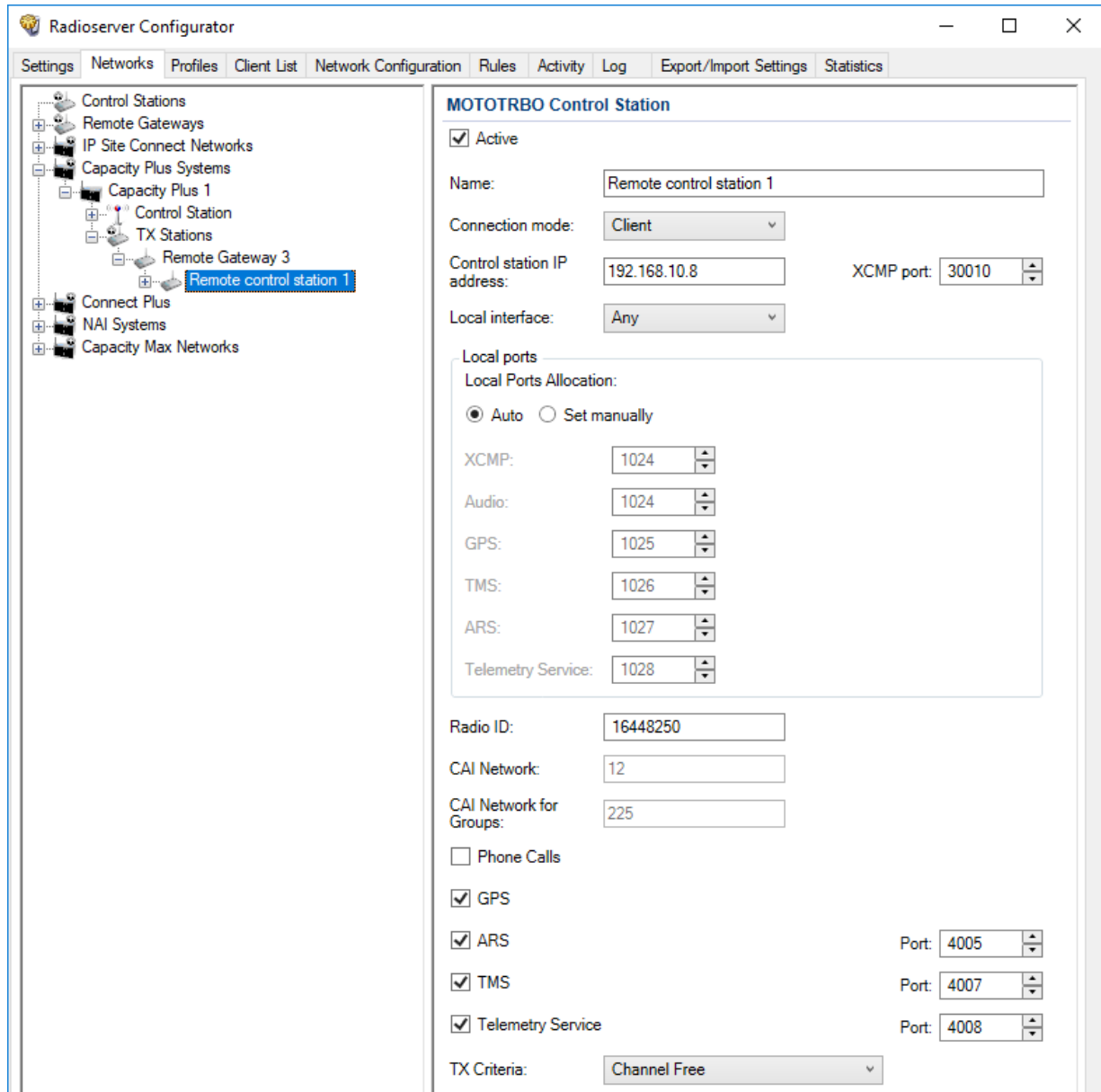

- In the right pane, select the **Active** check box to unlock TX station settings.
- In the **Name** field, type the station name.
- Configure the gateway connection mode:

If RG-1000e is configured to accept SmartPTT connection requests,

perform the following actions:

- From the **Connection mode** list, select *Client*.
- In the **Control station IP address** field, type the control station IP address within the gateway.

3. In the **XCMP port** field, enter the port number of the corresponding radio gateway interface.

If RG-1000e is configured to initiate SmartPTT connection requests,

perform the following actions:

1. From the **Connection mode** list, select *Server*.
2. In the **XCMP local port** field, enter the radioserver port number allocated to accept RG-1000e connection requests.

7. From the **Local interface** list, select one of the following option:

To use any radioserver IP address for location requests and/or responses,

select *Any*.

To use the specific radioserver IP address for connection requests and/or responses,

select the IP address.

8. *(Optional)* Set SmartPTT Radioserver host ports for different types of data:

If you want local ports to be set automatically,

select *Auto*.

If you want to set specific local port values,

perform the following actions:

1. Select *Set manually*.
2. If available, in the **XCMP** field, enter the number of the port used to receive commands and service messages from the remote control station, and send commands and service messages to it.
3. In the **Audio** field, enter the number of the port used to receive voice from the remote control station, and send dispatcher voice to it.
4. In the **GPS** field, enter the number of the port used to receive the location updates from radios, and send location update requests to them over the remote control station.
5. In the **TMS** field, enter the number of the port used to receive text messages from radios over the control station, and send text messages from dispatchers over the remote control station.

6. In the **ARS** field, enter the number of the port used to receive presence information on radios within the RF coverage zone of the remote control station.
7. In the **Telemetry Service** field, enter the number of the port used to receive telemetry data over the control stations, and send telemetry commands over the control station.

9. In the **Radio ID** field, type the control station ID in the decimal notation.
10. Select the **Phone Calls** check box to allow phone calls initiation over the TX station.
11. Configure data transmission over the control station:

To receive location updates and information on movements beyond the RF coverage zones,

select the **GPS** check box.

Important

SmartPTT assumes that TX station uses *4001* as the location port.

To receive information about radio presence in the network,

perform the following actions:

1. Select the **ARS** check box.
2. To the right of the check box, in the field, enter the port number used to receive the data.

To support text messages and job tickets in the radio network,

perform the following actions:

1. Select the **TMS** check box.
2. To the right of the check box, in the field, enter the port number used to receive and transmit the data.

To receive telemetry data and send telemetry commands,

perform the following actions:

1. Select the **Telemetry Service** check box.
2. To the right of the check box, in the field, enter the port number used to receive and transmit the data.

12. From the **TX Criteria** list, select one of the following options:

If the control station is configured to transmit only when no other transmissions are detected over the radio channel,

select *Channel Free*.

If the control station is configured to notify other radios on interrupting their transmissions, select *Tx Interrupt*.



If the control station is configured to completely ignore other transmission over the radio channel, select *Always*.

Important

SmartPTT does **not** support color code criteria for outgoing transmissions.

13. To save changes, at the bottom of the SmartPTT Radioserver Configurator window, click **Save Configuration** ().

Postrequisites:

- Configure groups and channels. For details, see [Configuring Remote TX Station Groups](#).
- Configure audio settings. For details, see [Configuring Remote TX Station Audio](#).
- To apply changes immediately, at the bottom of the SmartPTT Radioserver Configurator window, click **Start** () or **Restart** ().

5.3.4.8.2 Configuring Remote TX Station Groups

Follow the procedure to add new or edit existing talkgroups and an All Call entry that will be available to SmartPTT dispatchers in Capacity Plus systems.

Prerequisites:

- Configure the remote TX station connection. For details, see [Configuring Remote TX Station Connection](#).
- From the control station codeplug, obtain talkgroup IDs.
- For each talkgroup (and All Call), obtain zone ID and channel ID where they are used as default contacts.

Procedure:

1. In SmartPTT Radioserver Configurator, open the **Networks** tab.
2. In the left pane, expand **Capacity Plus Systems** → **<System Name>** → **TX Stations** → **<Gateway Name>** → **<Station Name>**, and then click **Talkgroups / Channels**.

The list of groups appears in the right pane.

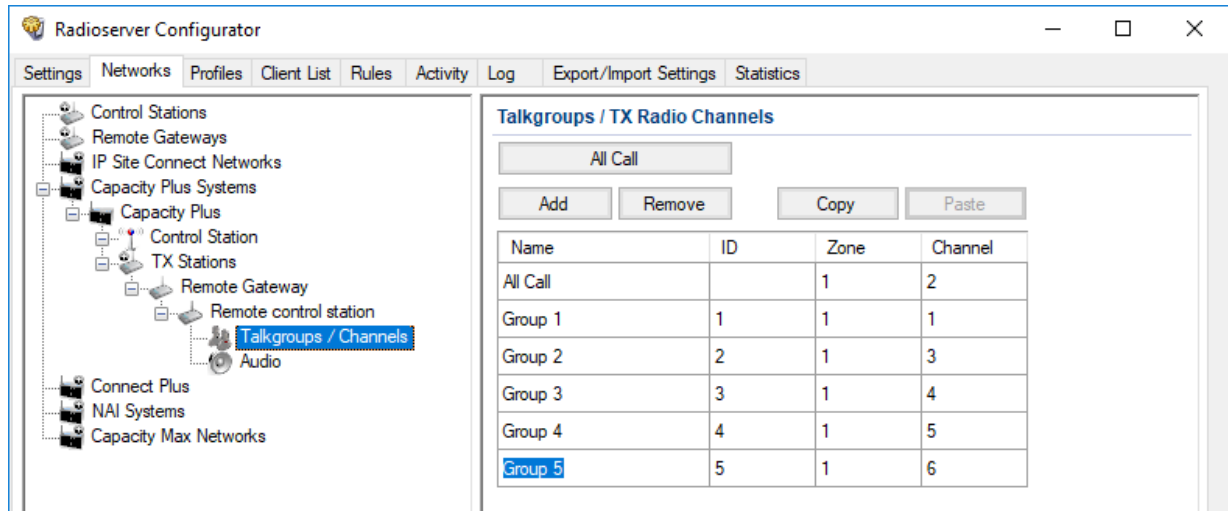

3. In the right pane, perform one of the following actions:

To add a new talkgroup,

click **Add**.

To add an All Call entry,

click **All Call**.

To edit an existing entry,

proceed to the next step of the procedure.



4. In the table, in the desired entry, perform the following actions:
 - a. In the **Name** column, double-click the current name, and then type the desired name.
 - b. In the **ID** column, double-click the current talkgroup ID, and then type the desired ID.

NOTE

For All Call, no ID is shown.

- c. In the **Zone** column, double-click the current ID, and then type the desired zone ID.
 - d. In the **Channel** column, double-click the current ID, and then type the desired channel ID.
5. To save changes, at the bottom of the SmartPTT Radioserver Configurator window, click **Save Configuration** ().

Postrequisites:

To apply changes immediately, at the bottom of the SmartPTT Radioserver Configurator window, click **Start** () or **Restart** ().

5.3.4.8.3 Configuring Remote TX Station Audio

Follow the procedure to edit audio settings required to receive voice from the control station and send dispatcher voice to it.

Prerequisites:

- From the RG-1000e codeplug, obtain voice encoding parameters.
- Configure the remote TX station connection. For details, see [Configuring Remote TX Station Connection](#).

Procedure:

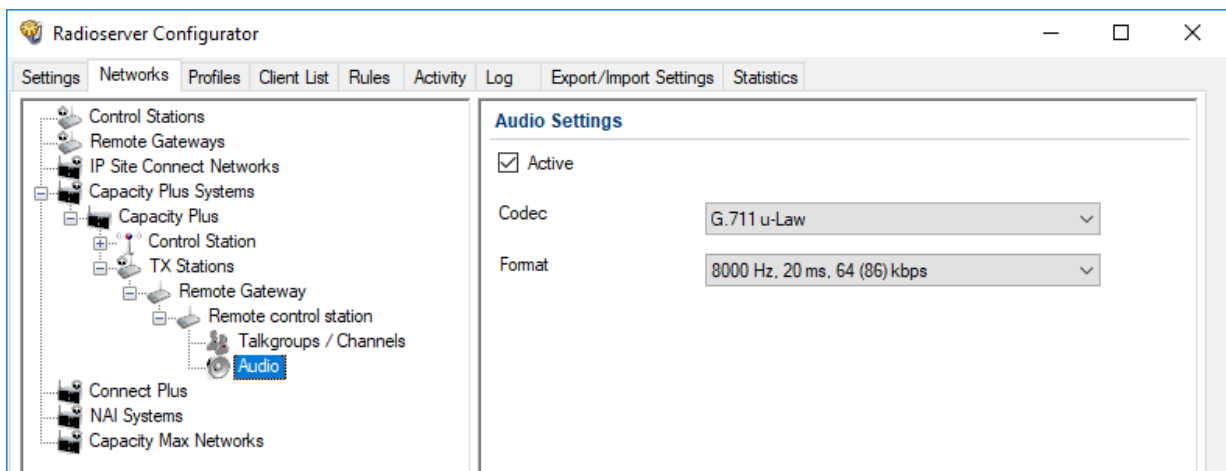

1. In SmartPTT Radioserver Configurator, open the **Networks** tab.
2. In the left pane, expand **Capacity Plus Systems** → **<System Name>** → **TX Stations** → **<Gateway Name>** → **<Station Name>**, and then click **Audio**.

The audio settings appear in the right pane.



3. In the right pane, select the **Active** check box to unlock audio settings.
4. From the **Codec** list, select the desired codec.
5. From the **Format** list, select the codec parameters.
6. To save changes, at the bottom of the SmartPTT Radioserver Configurator window, click **Save Configuration** ().

Postrequisites:

To apply changes immediately, at the bottom of the SmartPTT Radioserver Configurator window, click **Start** () or **Restart** ().

5.3.4.9 Duplicating TX Station Groups

Follow the procedure to duplicate the configured group calls in multiple TX stations.

Important

SmartPTT does **not** allow copying groups from the voice and data reception settings.

Prerequisites:

- Connect to the desired TX stations:
 - For information on local stations connection, see [Configuring Local TX Station Connection](#).
 - For information on remote stations connection, see [Configuring Remote TX Station Connection](#).
- Configure group calls in one of the TX stations:
 - For information on group calls for local stations, see [Configuring Local TX Station Groups](#).
 - For information on group calls for remote stations, see [Configuring Remote TX Station Groups](#).

Procedure:

1. In SmartPTT Radioserver Configurator, open the **Networks** tab.
2. In the left pane, access the configured group calls:

If group calls are configured in a local TX station,

expand **Capacity Plus Systems** → **<system name>** → **TX Stations** → **<station name>**, and then click **Talkgroups/Channels**.

If group calls are configured in a remote TX station,

expand **Capacity Plus Systems** → **<system name>** → **TX Stations** → **<gateway name>** → **<station name>**, and then click **Talkgroups/Channels**.

3. In the right pane, click **Copy**.
4. Access the group call settings of another TX station:

To access a local TX station,

in the left pane, under the **TX Stations** node, expand **<station name>**, and then click **Talkgroups/Channels**.

To access a remote TX station,

in the left pane, under the **TX Stations** node, expand **<gateway name>** → **<station name>**, and then click **Talkgroups/Channels**.

5. In the right pane, click **Paste**.
6. To save changes, at the bottom of the SmartPTT Radioserver Configurator window, click **Save Configuration** ().

Postrequisites:

- If required, repeat the procedure for other TX stations.
- To apply changes immediately, at the bottom of the SmartPTT Radioserver Configurator window, click **Start** (▶) or **Restart** (▶▶).

5.3.5 Capacity Plus Configuration (NAI)

Connection to Capacity Plus over NAI requires additional radio devices configuration, MNIS configuration, DDMS configuration, and dispatch software configuration.

Radio Devices Configuration

To support SmartPTT connection, the following actions must be performed:

- Radio IDs must be reserved for the following needs:
 - Dispatch subsystem (SmartPTT) identification.
 - MNIS identification.
 - *(Optional)* Individual dispatcher (operator) identification.
- Peer IDs (Repeater Radio IDs) must be reserved for the following needs:
 - SmartPTT identification as a software peer.
 - MNIS identification.
- MNIS Radio ID (**not** SmartPTT Radio ID) must be configured as the ARS ID in all radio codeplugs.
- All radios and repeaters must have equal CAI IDs and CAI Group IDs.
- IP address and UDP port of the master repeater must be obtained.
- Security keys must be obtained from radio codeplugs.

If you need assistance in the MOTOTRBO devices configuration, contact Motorola Solutions representatives in your region.

MNIS and DDMS Configuration

To configure MNIS and DDMS, the following actions must be performed:

- Dedicated IDs (Radio ID and Peer ID) must be assigned to MNIS.
- MNIS must be connected to the Capacity Plus master repeater.
- *(Optional)* RF site latitude and longitude must be configured in MNIS to increase the rate of radio location updates.
- Security keys must be configured in MNIS.
- DDMS address must be configured in MNIS.
- ARS ports must be synchronized in MNIS and DDMS.

If you need assistance in the MOTOTRBO software configuration, contact Motorola Solutions representatives in your region.

SmartPTT Configuration

To configure SmartPTT to work with Capacity Plus, the following actions must be performed:

- Connection to the master repeater must be configured. For details, see [Adding and Editing Capacity Plus \(NAI\)](#).
- SmartPTT Radioserver must be identified in the radio system. For details, see [Configuring SmartPTT Identification in Capacity Plus \(NAI\)](#).
- Talkgroups must be configured. For details, see [Adding and Editing Talkgroups in Capacity Plus \(NAI\)](#).
- DDMS connection must be configured in SmartPTT. For details, see [Configuring DDMS Connection](#).
- SmartPTT must be connected to the MNIS server. For details, see [Configuring MNIS Data Gateway](#).

If you need assistance in the SmartPTT configuration, submit a request to [SmartPTT Technical Support Center](#).

Network Monitoring

For network monitoring configuration in SmartPTT, the following actions must be performed:

- IP addresses of all repeaters in the system must be obtained.
- IP addresses of all other network devices must be obtained. This includes uninterruptible power supplies (UPS), switches, routers, etc.

5.3.5.1 Adding and Editing Capacity Plus (NAI)

Follow the procedure to add new or edit an existing connection to the radio system.

Prerequisites:

- Ensure that SmartPTT has the license for data exchange in the network. For details, see [Viewing License Items](#).
- From codeplugs of repeaters, obtain the following data:
 - IP address and UDP port of a master repeater.
 - Repeater private authentication key.
- If the repeater and radioserver are in different networks controlled by different routers over the router that supports Network Address Translation (NAT), obtain the IP address and UDP port that will be translated to the master repeater IP address and UDP port number.
- *(Optional)* Turn on SmartPTT monitoring. For details, see [Configuring Monitoring Database Connection](#).

Procedure:

1. In SmartPTT Radioserver Configurator, open the **Networks** tab.

2. In the left pane, perform one of the following actions:

To add a new network,

right-click the **NAI Systems** node, point to **Add**, and then select **NAI - Capacity Plus**.

To edit an existing network,

expand the **NAI Systems**, and then click the desired network.

The connection settings appear in the right pane of the tab.

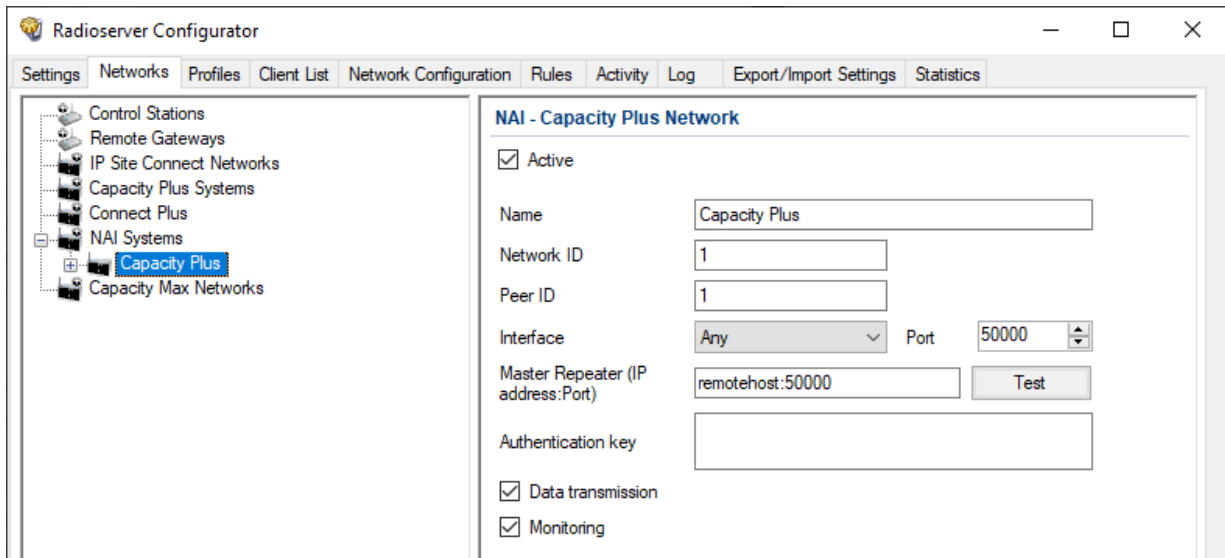

3. In the right pane, configure the general connection settings:

- a. Select the **Active** check box.
- b. In the **Name** field, type the radio system name.
- c. Leave the value in the **Network ID** field unchanged.

4. Configure the master repeater connection:

- a. In the **Peer ID** field, type the ID of the virtual repeater reserved for a radioserver.
- b. From the **Interface** list, select one of the following options:

To use any of the radioserver host IP addresses, select *Any*.

To fix the IP address, select the desired IP address.

Important

If a radioserver and MNIS are installed on the same computer, use fixed IP address that is different from the MNIS Tunnel IP address (by default, 192.168.56.1).



Important

If a radio or control station is connected to the computer, use fixed IP address that is different from the radio or control station IP address (by default, 192.168.10.1).

- c. In the **Port** field, enter the radioserver host port that will be used to connect to the repeater.

- d. In the **Master Repeater (IP address:Port)** field, type the IP address and UDP port that a radioserver will use to connect to the master repeater (includes the potential NAT use). Input format is <IP address in dot-decimal notation>:<UDP port>.
 - e. In the **Authentication key** field, type the repeater private authentication key.
 - f. *(Optional)* Click **Test** to check the repeater connection.
5. Select the **Data transmission** check box to allow SmartPTT data exchange with MNIS and DDMS services.
 6. *(Optional)* Select the **Monitoring** check box to turn on the radio system devices diagnostics.
 7. To save changes, at the bottom of the SmartPTT Radioserver Configurator window, click **Save Configuration** ().

Postrequisites:

- Identify a radioserver in the system. For details, see [Configuring SmartPTT Identification in Capacity Plus \(NAI\)](#).
- Configure talkgroups in the network. For details, see [Adding and Editing Talkgroups in Capacity Plus \(NAI\)](#).
- If data transmission is allowed, configure DDMS service. For details, see [Configuring DDMS Connection](#).
- If data transmission is allowed, configure MNIS service. For details, see [Configuring MNIS Data Gateway](#).
- To apply changes immediately, at the bottom of the SmartPTT Radioserver Configurator window, click **Start** () or **Restart** ().
- *(Optional)* Configure network device monitoring.

5.3.5.2 Configuring SmartPTT Identification in Capacity Plus (NAI)

Follow the procedure to configure SmartPTT identification in the radio network.

Prerequisites:

- Configure the network settings. For details, see [Adding and Editing Capacity Plus \(NAI\)](#).
- From radio codeplugs, obtain the following data:
 - CAI and CAI group values.
 - CSBK data settings (active or inactive).
- From the MNIS configuration file, obtain information on the repeater location (configured or not).

Procedure:

1. In SmartPTT Radioserver Configurator, open the **Networks** tab.

- In the left pane, expand **NAI Systems** → **<system name>**, and then click **<slot name>**.
The identification parameters appear in the right pane of the tab.

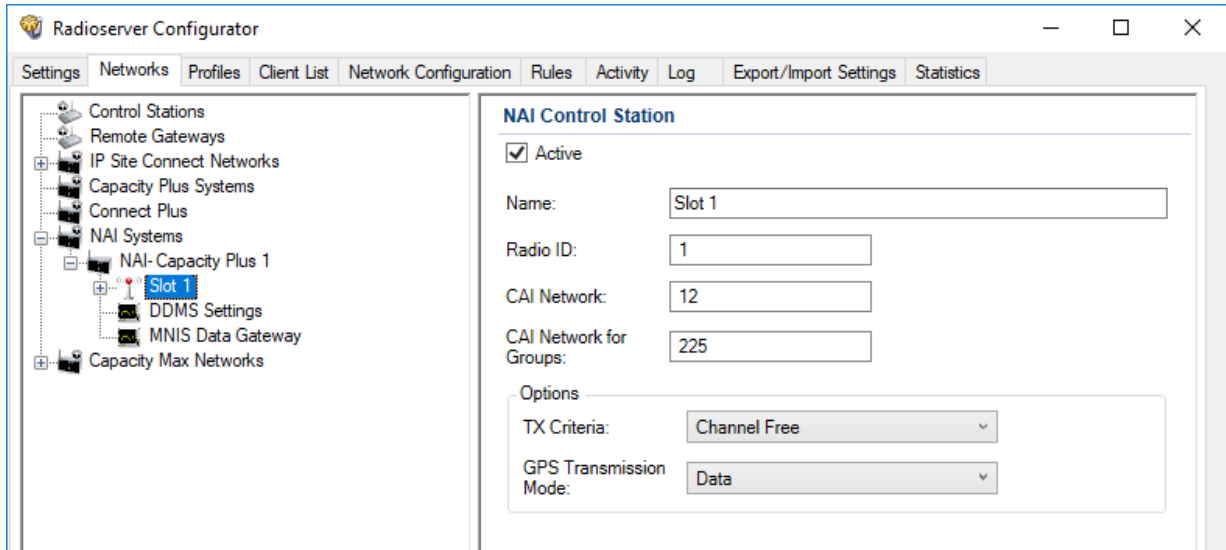

- In the right pane, select the **Active** check box.
- In the **Name** field, type the title that will represent the radio network in SmartPTT Dispatcher.
- Type the SmartPTT Radioserver identification parameters:
 - In the **Radio ID** field, type the radio ID that is reserved for SmartPTT Radioserver.
 - In the **CAI Network** field, type the CAI ID.
 - In the **CAI Network for Groups** field, type the CAI Group ID.
- From the **TX Criteria** list, select one of the following options:

If the call initiator must transmit only when no other transmissions are detected over the radio channel, select *Channel Free*.

If the call initiator must interrupt another participant of the radio network according to the selected MSI or DMR protocol, select *Tx Interrupt*.

If the call initiator must completely ignore other transmissions over the radio channel, select *Always*.

- From the **GPS Transmission Mode** list, select one of the following options:



If CSBK data is used in the radio system and site coordinates are configured in MNIS, select *Enhanced CSBK*.

If CSBK data is used in the radio system but site coordinates are **not** configured in MNIS, select *CSBK*.

In CSBK data is **not** used in the radio system or select *Data*.
 outdoor positioning service is used together with
 indoor positioning service,

- To save changes, at the bottom of the SmartPTT Radioserver Configurator window, click **Save Configuration** ().

Postrequisites:

- Configure talkgroups. For details, see [Adding and Editing Talkgroups in Capacity Plus \(NAI\)](#).
- To apply changes immediately, at the bottom of the SmartPTT Radioserver Configurator window, click **Start** () or **Restart** ().

5.3.5.3 Adding and Editing Talkgroups in Capacity Plus (NAI)

Follow the procedure to add or edit talkgroups available in the system.

Prerequisites:

- Configure SmartPTT identification in the radio network. For details, see [Configuring SmartPTT Identification in Capacity Plus \(NAI\)](#).
- From repeater codeplugs, obtain talkgroup IDs.

Procedure:

- In SmartPTT Radioserver Configurator, open the **Networks** tab.
- In the left pane, expand **IP Site Connect Networks** → **<network name>** → **<slot name>**, and then select **Talkgroups**.

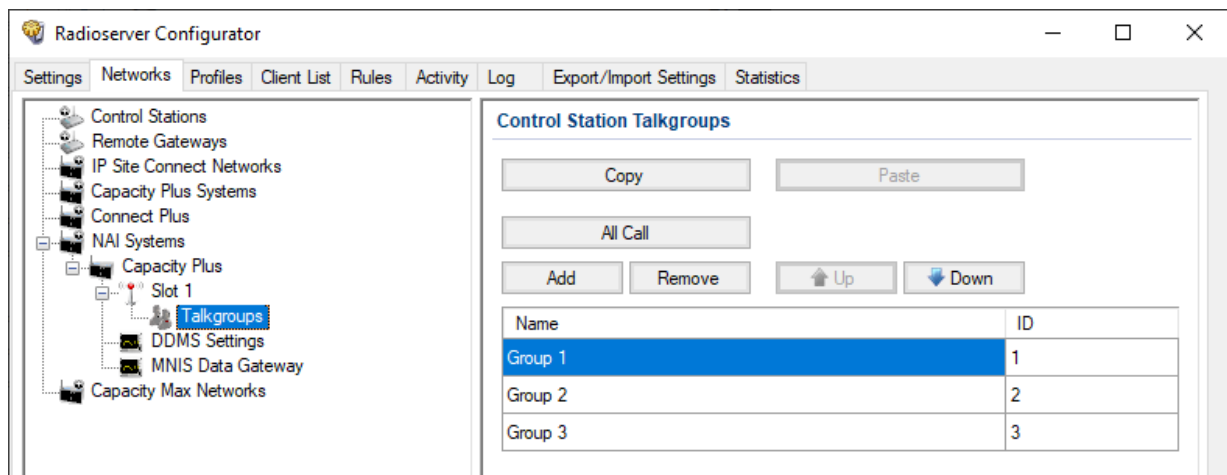

- In the right pane, perform one of the following actions:



To add a new talkgroup, click **Add**.

To edit an existing entry, proceed to the next step of the procedure.

- In the table, in the desired entry, perform the following actions:

- a. In the **Name** column, double-click the current talkgroup name, and then type the desired name.
 - b. In the same row, in the **ID** column, double-click the current talkgroup ID, and then type the desired ID.
5. (Optional) Using **Up** and **Down** buttons, reorder entries in the table.
 6. To save changes, at the bottom of the SmartPTT Radioserver Configurator window, click **Save Configuration** ().

Postrequisites:

To apply changes immediately, at the bottom of the SmartPTT Radioserver Configurator window, click **Start** () or **Restart** ().

5.4 Linked Capacity Plus

Linked Capacity Plus (Capacity Plus Multi-Site) is a digital (DMR) trunked radio system. It is a multisite system (provides great RF coverage) that provides several simultaneous voice calls on the site. For information on the radio system and its capabilities, see [MOTOTRBO™ Capacity Plus Multi-Site](#) on the Motorola Solutions website.

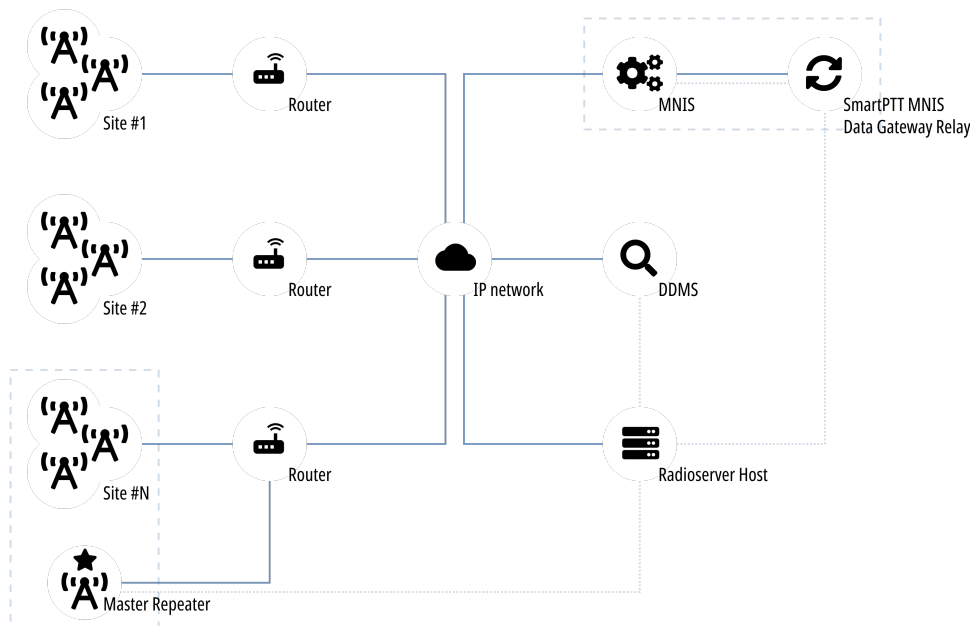

SmartPTT is able to connect to multiple Linked Capacity Plus radio systems at once. For connection, Network Application Interface (NAI) is used that is provided by Motorola Solutions. Using NAI requires to use the following additional software:

- MOTOTRBO Network Interface Service (MNIS) provides data communication between the radio system and SmartPTT.
- Device Discovery and Mobility Service (DDMS) provides ARS information to SmartPTT.

SmartPTT Radioserver requires simultaneous connection to master repeater, MNIS, and DDMS (see dotted lines on the diagram). To connect to the MNIS service that is installed on the dedicated computer (not on the SmartPTT Radioserver host), SmartPTT MNIS Data Gateway Relay is required.

In Linked Capacity Plus, master repeater is a real radio system repeater. It can be installed on any site of the system. No software component (including SmartPTT) is able to perform this function.

5.4.1 SmartPTT Features in LCP

Linked Capacity Plus provides the following features to SmartPTT:

- Information on radio presence in the network (ARS).
- Radio user identification.
- Radio location updates (includes revert channel support).
- Text messaging and job ticketing.
- Telemetry and remote control over radios.

Important

SmartPTT does **not** support voice calls and radio commands in Linked Capacity Plus.

For Linked Capacity Plus, SmartPTT provides the following features:

- Simultaneous connection to multiple Linked Capacity Plus radio systems.
- Event logging.
- Rules configuration.

For network monitoring, the following features are provided:

- Network device monitoring over SNMP.
- Over-the-air traffic monitoring (without splitting by radio channels).
- Network topology visualization.

NOTE

SmartPTT does **not** show on-site/fielded radios on the topology diagram.

- Statistical information gathering (system performance, alarm statistics), reports generation.

5.4.2 Linked Capacity Plus Configuration

Linked Capacity Plus connection requires additional radio devices configuration, MNIS configuration, DDMS configuration, and dispatch software configuration.

Radio Devices Configuration

To support SmartPTT connection, the following actions must be performed:

- Radio IDs must be reserved for the following needs:
 - Dispatch subsystem (SmartPTT) identification.
 - MNIS identification.
 - *(Optional)* Individual dispatcher (operator) identification.
- Peer IDs must be reserved for the following needs:
 - SmartPTT identification as a software peer.
 - MNIS identification.
- MNIS Radio ID (**not** SmartPTT Radio ID) must be configured as the ARS ID in all radio codeplugs.
- All radios and repeaters must have the same CAI IDs and CAI Group IDs.
- IP address and UDP port of the master repeater must be obtained.
- Security keys configured in radio codeplugs must be obtained.
- In repeater codeplugs, site-to-site call routing must be configured.

If you need assistance in the MOTOTRBO devices configuration, contact Motorola Solutions representatives in your region.

MNIS and DDMS Configuration

To configure MNIS and DDMS, the following actions must be performed:

- Dedicated IDs (Radio ID and Peer ID) must be assigned to MNIS.
- MNIS must be connected to the master repeater.
- *(Optional)* Repeater coordinates must be configured in MNIS to increase the rate of radio location updates.
- Security keys that are configured in radio codeplugs must be configured in MNIS.
- DDMS address must be configured in MNIS.
- ARS ports must be synchronized in MNIS and DDMS.

If you need assistance in the MOTOTRBO software configuration, contact Motorola Solutions representatives in your region.

SmartPTT Configuration

To configure SmartPTT to work in Linked Capacity Plus, the following actions must be performed:

- Connection to the master repeater must be configured. For details, see [Adding and Editing LCP Connection](#).
- SmartPTT Radioserver must be identified in the radio system. For details, see [Configuring SmartPTT Identification](#).
- Talkgroups must be configured. For details, see [Adding and Editing Groups in LCP](#).
- SmartPTT must be connected to DDMS. For details, see [Configuring DDMS Connection](#).
- SmartPTT must be connected to MNIS. For details, see [Configuring MNIS Data Gateway](#).

If you need assistance in the SmartPTT configuration, submit a request to [SmartPTT Technical Support Center](#).

Network Monitoring

For network monitoring configuration in SmartPTT, the following actions must be performed:

- IP addresses of all repeaters in the system must be obtained.
- IP addresses of all other network devices must be obtained. This includes uninterruptible power supplies (UPS), switches, routers, etc.

5.4.2.1 Adding and Editing LCP Connection

Follow the procedure to add a new or edit an existing connection to the radio system.

Prerequisites:

- From repeater codeplugs, obtain the following data:
 - Master repeater IP address and UDP port number.
 - Repeater private authentication key.
- If the master repeater and radioserver are connected over the router that supports Network Address Translation (NAT), obtain the IP address and UDP port that will be translated to the master repeater IP address and UDP port number.
- *(Optional)* Turn on SmartPTT monitoring. For details, see [Configuring Monitoring Database Connection](#).

Procedure:

1. In SmartPTT Radioserver Configurator, open the **Networks** tab.
2. In the left pane, perform one of the following actions:

To add a new network, right-click the **NAI Systems** node, then point to **Add**, and then select **NAI - Linked Capacity Plus**.

To modify an existing network, expand the **NAI Systems** node, and then click **<network name>**.

The connection settings appear in the right pane of the tab.

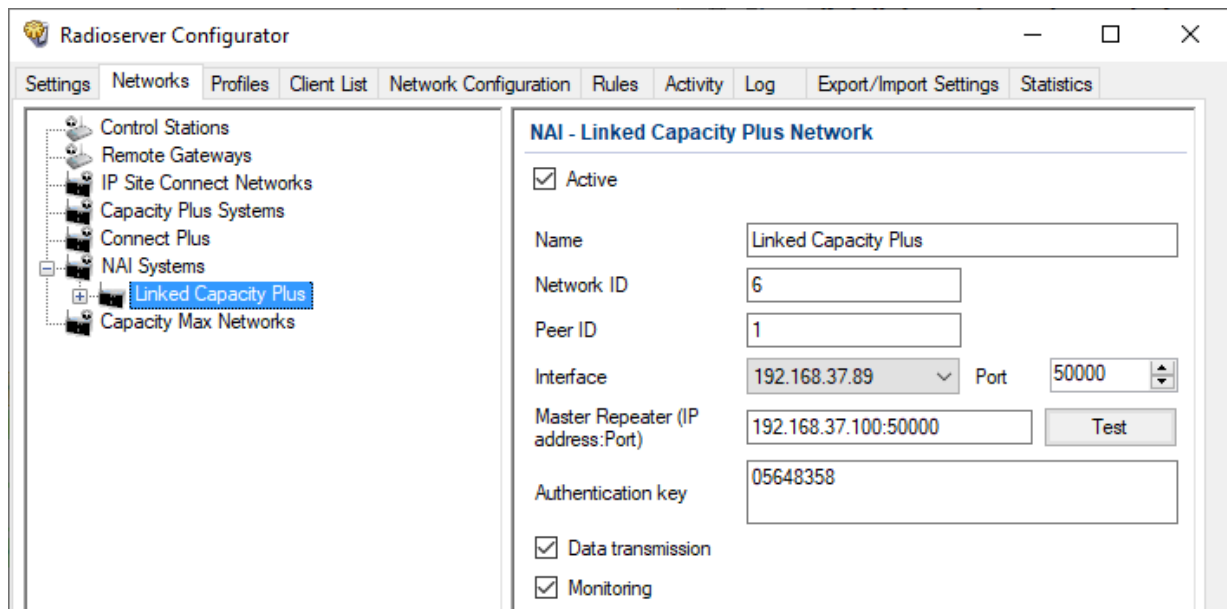

3. In the right pane, configure the general connection settings:
 - a. Select the **Active** check box.
 - b. In the **Name** field, type the radio system name.
 - c. Leave the value in the **Network ID** field unchanged.
4. Configure the master repeater connection:
 - a. In the **Peer ID** field, type the ID of the virtual repeater reserved for a radioserver.
 - b. From the **Interface** list, select one of the following options:

To use any of the radioserver host IP addresses, select *Any*.

To fix the IP address, select the desired IP address.

Important



If a radioserver and MNIS are installed on the same computer, use fixed IP address that is different from the MNIS Tunnel IP address (by default, *192.168.56.1*).

Important

If a radio or control station is connected to the computer, use fixed IP address that is different from the radio or control station IP address (by default, 192.168.10.1).

- c. In the **Port** field, enter the radioserver host port that will be used to connect to the repeater.
 - d. In the **Master Repeater (IP address:Port)** field, type the IP address and UDP port that a radioserver will use to connect to the master repeater (includes the potential NAT use). Input format is <IP address in dot-decimal notation>:<UDP port>.
 - e. In the **Authentication key** field, type the repeater private authentication key.
 - f. *(Optional)* Click **Test** to check the repeater connection.
5. Select the **Data transmission** check box to allow SmartPTT data exchange with MNIS and DDMS services.
 6. *(Optional)* Select the **Monitoring** check box to turn on the radio system devices diagnostics.
 7. To save changes, at the bottom of the SmartPTT Radioserver Configurator window, click **Save Configuration** ().

Postrequisites:

- Identify a radioserver in the system. For details, see [Configuring SmartPTT Identification](#).
- Configure talkgroups in the network. For details, see [Adding and Editing Groups in LCP](#).
- To apply changes immediately, at the bottom of the SmartPTT Radioserver Configurator window, click **Start** () or **Restart** ().
- *(Optional)* Configure network device monitoring.

5.4.2.2 Configuring SmartPTT Identification

Follow the procedure to configure SmartPTT identification in the radio network.

Prerequisites:

- Configure the network settings. For details, see [Adding and Editing LCP Connection](#).
- From radio codeplugs, obtain the following data:
 - CAI and CAI group values.
 - CSBK data settings (active or inactive).
- From the MNIS configuration file, obtain information on the site coordinates (configured or not).

Procedure:

1. In SmartPTT Radioserver Configurator, open the **Networks** tab.

- In the left pane, expand **NAI Systems** → <system name>, and then click <slot name>. The identification parameters appear in the right pane of the tab.

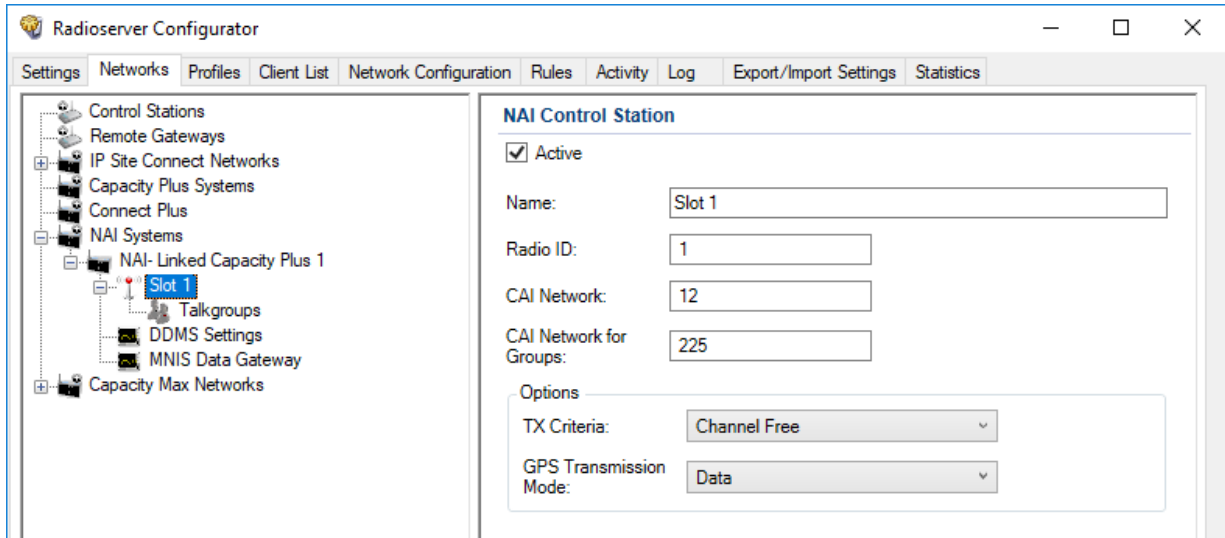

- In the right pane, select the **Active** check box.
- In the **Name** field, type the title that will represent the radio network in SmartPTT Dispatcher.
- Type the SmartPTT Radioserver identification parameters:
 - In the **Radio ID** field, type the radio ID that is reserved for SmartPTT Radioserver.
 - In the **CAI Network** field, type the CAI ID.
 - In the **CAI Network for Groups** field, type the CAI Group ID.
- From the **TX Criteria** list, select one of the following options:

If the call initiator must transmit only when no other transmissions are detected over the radio channel, select *Channel Free*.

If the call initiator must interrupt another participant of the radio network according to the selected MSI or DMR protocol, select *Tx Interrupt*.

If the call initiator must completely ignore other transmissions over the radio channel, select *Always*.

- From the **GPS Transmission Mode** list, select one of the following options:



If CSBK data is used in the radio system and site coordinates are configured in MNIS, select *Enhanced CSBK*.

If CSBK data is used in the radio system but site coordinates are **not** configured in MNIS, select *CSBK*.

In CSBK data is **not** used in the radio system or select *Data*.
 outdoor positioning service is used together with
 indoor positioning service,

- To save changes, at the bottom of the SmartPTT Radioserver Configurator window, click **Save Configuration** ().

Postrequisites:

To apply changes immediately, at the bottom of the SmartPTT Radioserver Configurator window, click **Start** () or **Restart** ().

5.4.2.3 Adding and Editing Groups in LCP

Follow the procedure to configure talkgroups in the radio system.

Prerequisites:

From repeater codeplugs, obtain the list of talkgroups for each radio system site.

Procedure:

- In SmartPTT Radioserver Configurator, open the **Networks** tab.
- In the left pane, expand **NAI Systems** → **<system name>** → **<slot name>**, and then select **Talkgroups**. The group settings appear in the right pane.

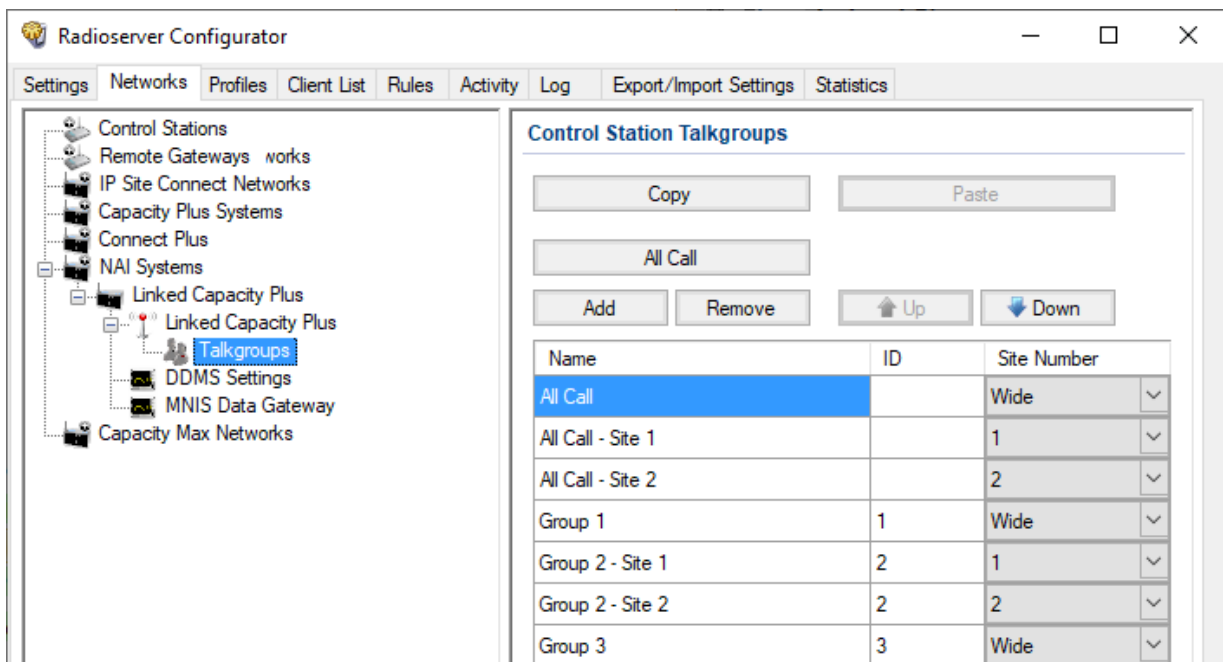

- In the right pane, perform one of the following actions:

To add a new talkgroup, click **Add**.

To edit an existing talkgroup, proceed to the next step of the procedure.

- In the table, in the desired row, perform the following actions:



- a. In the **Name** column, double-click the current name, and then type the desired name.
- b. In the same row, in the **ID** column, double-click the current ID, and then type the desired ID.
- c. In the same row, from the **Site Number** list, select one of the following options:

To configure system-wide talkgroup, select *Wide*.

To configure site-specific talkgroup, select the desired site number (site ID).

5. (Optional) Using **Up** and **Down** buttons, reorder rows in the table.
6. To save changes, at the bottom of the SmartPTT Radioserver Configurator window, click **Save Configuration** ().

Postrequisites:

To apply changes immediately, at the bottom of the SmartPTT Radioserver Configurator window, click **Start** () or **Restart** ().

5.5 Capacity Max

MOTOTRBO™ Capacity Max is a multisite trunked radio system from Motorola Solutions. The system is compliant with ETSI DMR Tier III standards, supports up to 250 sites with up to 3,000 users per site. It provides connections alternation/redundancy and information security. For details, visit the [MOTOTRBO™ Capacity Max](#) web page of the Motorola Solutions website.

Capacity Max is available to SmartPTT over the Capacity Max System Server device (CMSS) connection. CMSS is a controller that provides the Presence Server interface (information about radios and their online/offline status).

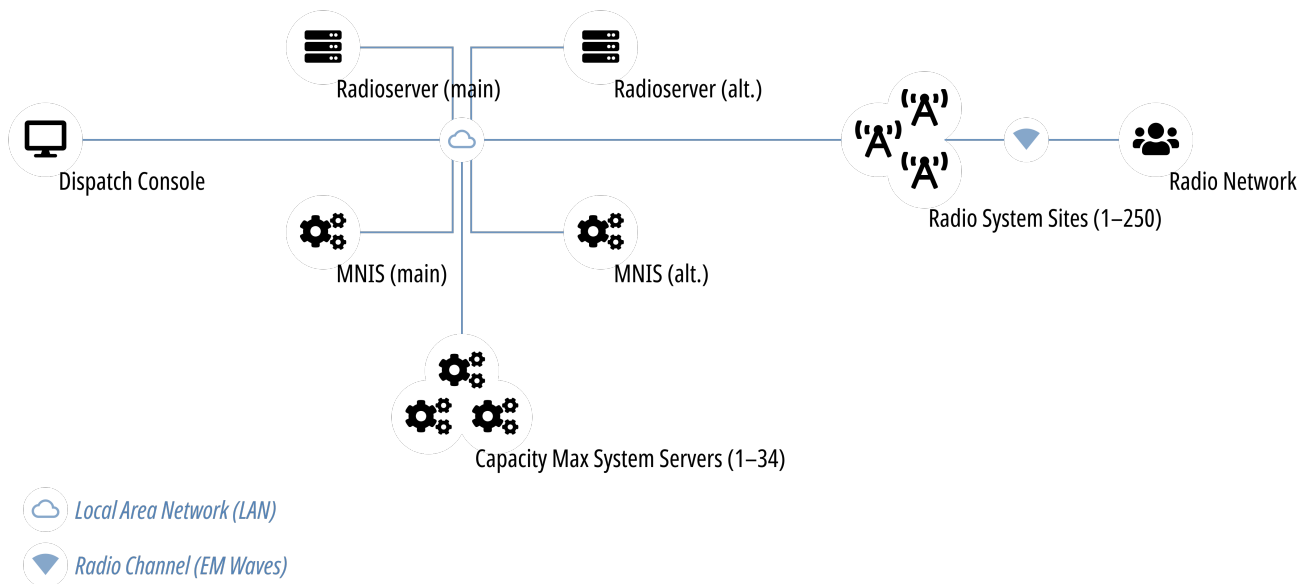

Each CMSS provides only one Presence Server interface. For each alternate/redundant interface, another CMSS is required.

Text messages, positioning information, and telemetry data are provided by the MNIS Data Gateway. It is represented with the MOTOTRBO Network Interface Service (MNIS), a Windows services from Motorola Solutions that is hosted on a regular computer outside CMSS.

5.5.1 Capacity Max Feature Overview

Capacity Max provides and supports the following features:

- Text messaging.
- Outdoor (GNSS) positioning services.
- Data acquisition and remote control over MOTOTRBO radios.
- Wireless traffic encryption using MOTOTRBO enhanced privacy or AES-compliant privacy.
- Presence Server, MNIS VRG Gateway, and MNIS Data Gateway alternation/redundancy.
- Secure connection between SmartPTT Radioserver and CMSS.

Licensing

To support Capacity Max, SmartPTT Radioserver requires the following licenses:

Capacity Max Presence Connectivity

Each license unlocks the connection to the Presence Server and up to 4 alternate/redundant Presence Servers (optional).

Capacity Max Data Connectivity

Each license unlocks the connection to the MNIS Data Gateway and the alternate/redundant MNIS Data Gateway (optional).

NOTE

If you are using the remotely installed MNIS Data Gateway, please install and configure SmartPTT MNIS Data Gateway Relay.

AES Encryption Support

The license makes symmetric security keys available for configuration.

For information on CMSS licenses, contact the Motorola Solutions representative in your region.

Limitations

For SmartPTT operators, the following features are unavailable in Capacity Max:

- Voice calls and voice notifications
- Radio signaling
- SmartPTT Bridging
- Network equipment diagnostics (SmartPTT Monitoring).

SmartPTT Radioserver ignores Radio Stun, Radio Revive, and Radio Kill commands sent to SmartPTT Radioserver ID and dispatch profile IDs.

5.5.2 Capacity Max Configuration Brief

The following information is required to start Capacity Max Configuration in SmartPTT.

Identifier Reservation

In Capacity Max, SmartPTT Radioserver requires a numeric ID that must be unique across all Radio IDs in the whole radio system. The ID should be the same for main and alternate/redundant SmartPTT Radioserver. If radio subscribers send message to this ID, SmartPTT Radioserver will share/retransmit it to all active operators.

To deliver a private communication between dispatchers and radio subscribers, unique IDs must be reserved to dispatchers. IDs must be set on the **Clients** tab of SmartPTT Radioserver Configurator. In the document, these IDs are referred to as "Dispatcher IDs".

Configuration Software

Configuration of Capacity Max in SmartPTT requires the following software:

- SmartPTT Radioserver Configurator that provides SmartPTT Radioserver settings.
- Radio Management Configuration Client (RMCC) that provides the radio system settings and CMSS settings.
- SmartPTT MNIS Data Gateway Relay that routes data between the remote MNIS Data Gateway and SmartPTT Radioserver.

Configuration Process

The process includes the following actions:

1. Radio system addition and general SmartPTT Radioserver configuration. For details, see [Adding and Editing Capacity Max](#).
2. Presence Server connection. For details, see [Connecting to Presence Servers](#).
3. MNIS Data Gateway connection. For details, see [Connecting to Data Gateways](#).
4. Group call recipients configuration. For details, see [Adding and Editing Groups in Capacity Max](#).
5. Correct settings synchronization between the main and alternate/redundant SmartPTT Radioservers.

Instructions provide an information on how to obtain CMSS settings if required.

5.5.3 Adding and Editing Capacity Max

Follow the procedure to add Capacity Max to the SmartPTT Radioserver configuration.

Prerequisites:

From Capacity Max configuration, obtain the following information:

- SmartPTT Radioserver ID,
- Availability of the data service;

- If CSBK Data are used or not.

Contact the Motorola Solutions representative in your region to obtain the configured parameters.

Procedure:

1. In SmartPTT Radioserver Configurator, open the **Networks** tab.
2. Perform one of the following actions:

To add a new Capacity Max network, right-click **Capacity Max Networks**, and then click **Add**.

To edit an existing Capacity Max network, expand **Capacity Max Networks**.

3. Under the expanded **Capacity Max Networks** node, click the desired network.
The general network settings appear in the right panel.

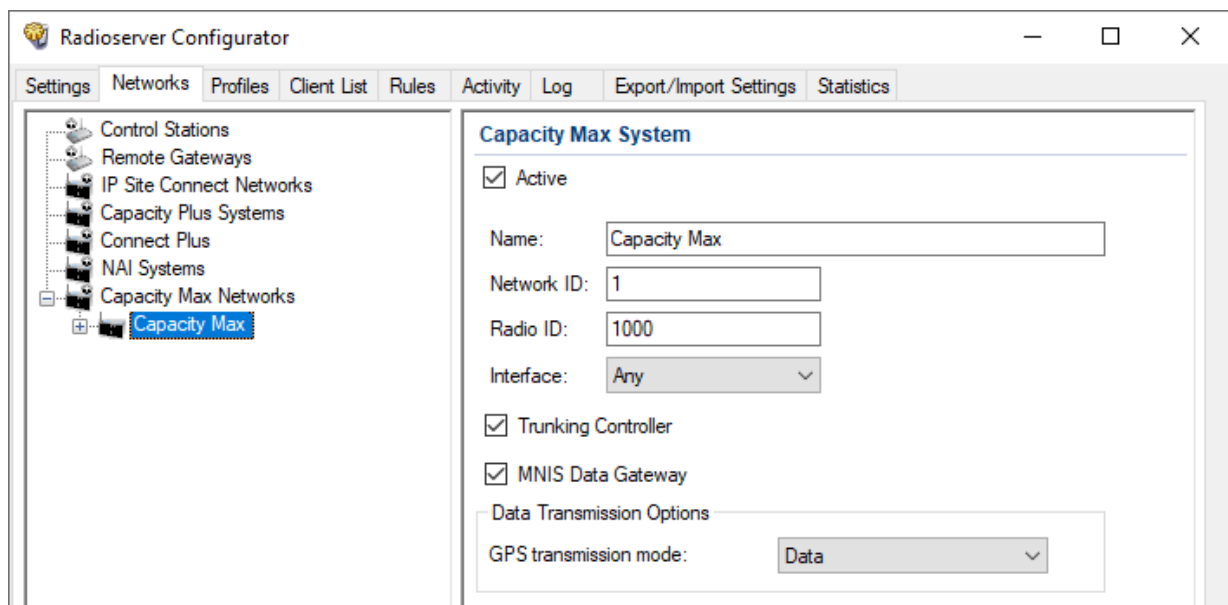



4. Click a new subnode.
5. In the right pane, configure the general SmartPTT Radioserver settings:
 - a. Select the **Active** check box.
 - b. In the **Name** field, type the radio network name.
 - c. Leave the **Network ID** parameter unchanged.
 - d. In the **Radio ID** field, type the Dispatch System ID.
6. Show Capacity Max service settings:
 - a. Select the **Trunking Controller** check box to show the Presence Server connection settings. The **Trunking Controller** subnode appears.
 - b. Select the **MNIS Data Gateway** check box to show the MNIS Data Gateway connection and communication settings. The **MNIS Data Gateway** subnode appears.

7. To configure GPS data format, in the **Data Transmission Options** area, perform one of the following actions:

If CSBK Data are configured in the radio network,	from the GPS Transmission mode list, select <i>Enhanced CSBK</i> .
If no CSBK Data are configured,	from the GPS Transmission mode list, select <i>Data</i> .
If no data gateway will be used in Capacity Max,	leave the GPS Transmission mode parameter unchanged.
8. To save changes, at the bottom of the SmartPTT Radioserver Configurator window, click **Save Configuration** ().

Postrequisites:

To apply changes immediately, at the bottom of the SmartPTT Radioserver Configurator window, click **Start** () or **Restart** ().

5.5.4 Connecting to Presence Servers

Follow the procedure to connect the SmartPTT Radioserver to the Presence Server.

Prerequisites:

From the Capacity Max configuration, obtain the following information:

- IPv4 address and port number of the main/primary Presence Server interface.
- IPv4 addresses and port numbers of the all alternate/redundant Presence Server interfaces.

Contact the Motorola Solutions representative in your region to obtain the configured parameters.

Procedure:

1. In SmartPTT Radioserver Configurator, open the **Networks** tab.
2. Access Presence Server connection settings:
 - a. On the tab, in the left pane, expand **Capacity Max Network**, and then select **<your network>**.
 - b. In the right pane, select the **Trunking Controller** check box, or ensure that it is already selected.
 - c. In the left pane, expand **<your network>**, and then select **Trunking Controller**.
The Presence Server settings appear in the right pane.

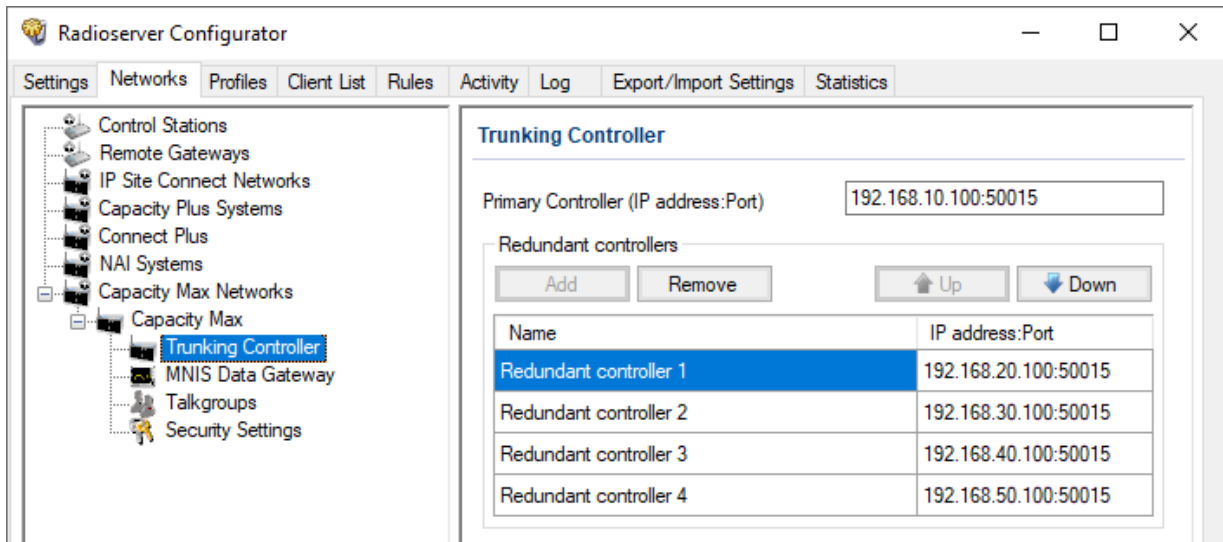

3. In the right pane, in the **Primary Controller** field, type <Main Presence Server IP>:<Main Presence Server Port>.
4. In the **Redundant controllers** area, configure the connection to alternate/redundant Presence Servers:
 - a. Perform one of the following actions:

To add a new connection, click **Add**.

To edit an existing connection, proceed to the next step of the procedure.



- b. In the new row, in the **IP address:Port** column, double-click the default value, and type <Alt. Presence Server IP>:<Alt. Presence Server Port>.
- c. *(Optional)* In the **Name** column, double-click the default value, and type the **Presence Server** name.

NOTE

Names of the alternate/redundant Presence Servers are used in the system messages of SmartPTT Dispatcher.

5. If more than one alternate Presence Server is configured in Capacity Max, repeat the previous step for the remaining Presence Servers.
6. *(Optional)* Using **Up** and **Down** buttons, reorder rows in the table.
7. To save changes, at the bottom of the SmartPTT Radioserver Configurator window, click **Save Configuration** ().

Postrequisites:

To apply changes immediately, at the bottom of the SmartPTT Radioserver Configurator window, click **Start** () or **Restart** ().

5.5.5 Connecting to Data Gateways

Follow the procedure to connect SmartPTT Radioserver to the MNIS Data Gateway.

Prerequisites:

- From the Capacity Max configuration, obtain the following information:
 - Main/primary data gateway settings.
 - If available, alternate/redundant data gateway settings.

Contact the Motorola Solutions representative in your region to obtain the configured parameters.

- From MNIS Data Gateway Relay, obtain its IP address and port. For details, see [Configuring SmartPTT MNIS Data Gateway Relay](#).

Procedure:

1. In SmartPTT Radioserver Configurator, open the **Networks** tab.
2. Access data gateway settings:
 - a. On the tab, in the left pane, expand **Capacity Max Networks**, and then select **<your network>**.
 - b. In the right pane, select the **MNIS Data Gateway** check box, or ensure that it is selected.
 - c. In the left pane, expand **<your network>**, and then select **MNIS Data Gateway**.
The data gateway settings appear in the right pane.

The screenshot shows the Radioserver Configurator application window. The 'Networks' tab is selected, and the left pane shows a tree view with 'Capacity Max Networks' expanded to 'Capacity Max', which is further expanded to 'MNIS Data Gateway'. The right pane displays the configuration for the 'MNIS Data Gateway'.

MNIS Data Gateway	
Socket Type	Local Socket
Interface	192.168.56.1
MNIS Control Server (IP address:Port)	192.168.10.10:55000
MNIS ID	1
Location Port (LRRP)	4001
TMS Port	4007
Telemetry Port	4008
<input checked="" type="checkbox"/> Redundant MNIS data gateway	
Socket Type	Remote Socket
MNIS Control Server (IP address:Port)	192.168.10.11:55000
MNIS Relay Server (IP address:Port)	192.168.10.11:8890
Location Port (LRRP)	4011
TMS Port	4017
Telemetry Port	4018

3. Connect to the main MNIS Data Gateway:

If the MNIS service and SmartPTT Radioserver are hosted on the same computer,

perform the following actions:

1. In the right pane, from the **Socket Type** list, select *Local Socket*.
2. From the **Interface** list, select the MNIS Tunnel IP address.
The default MNIS Tunnel IP is *192.168.56.1*.
3. In the **MNIS Control Server** field, type <SmartPTT Radioserver IP>:<MNIS Control Interface TCP Port>.

If the MNIS service and SmartPTT Radioserver are hosted on different computers,

perform the following actions:

1. In the right pane, from the **Socket Type** list, select *Remote Socket*.
2. In the **MNIS Control Server** field, type <MNIS host IP>:<MNIS Control Interface TCP Port>.
3. In the **MNIS Relay Server** field, type <MNIS host IP>:<SmartPTT MNIS Data Gateway Relay Port>.

4. Configure MNIS Data Gateway settings:

- a. In the **MNIS ID** field, enter MNIS ID.
- b. In the **Location Port (LRRP)** field, enter the MNIS port used to provide the outdoor coordinates using the LRRP protocol.
- c. In the **TMS Port** field, enter the MNIS port used to receive and send text messages.
- d. In the **Telemetry Port** field, enter the MNIS port used for data acquisition and remote control commands.

5. Configure the alternate/redundant MNIS Data Gateway:

- a. Select the **Redundant MNIS data gateway** check box.
- b. With controls in the **Redundant MNIS data gateway** area, perform the actions described in [step 3](#).
- c. With the remaining controls of the area, perform the actions described in [step 4](#).

6. To save changes, at the bottom of the SmartPTT Radioserver Configurator window, click **Save Configuration** ().

Postrequisites:

To apply changes immediately, at the bottom of the SmartPTT Radioserver Configurator window, click **Start** (▶) or **Restart** ().

5.5.6 Adding and Editing Groups in Capacity Max

Follow the procedure to add talkgroups to SmartPTT Radioserver.

Prerequisites:

From the Capacity Max configuration, obtain talkgroup IDs that must be available in SmartPTT Dispatcher. Contact the Motorola Solutions representative in your region to obtain the configured parameters.

Procedure:

1. In SmartPTT Radioserver Configurator, open the **Networks** tab.
2. On the tab, in the left pane, expand **Capacity Max Networks** → **<your network>**, and then select **Talkgroups**.

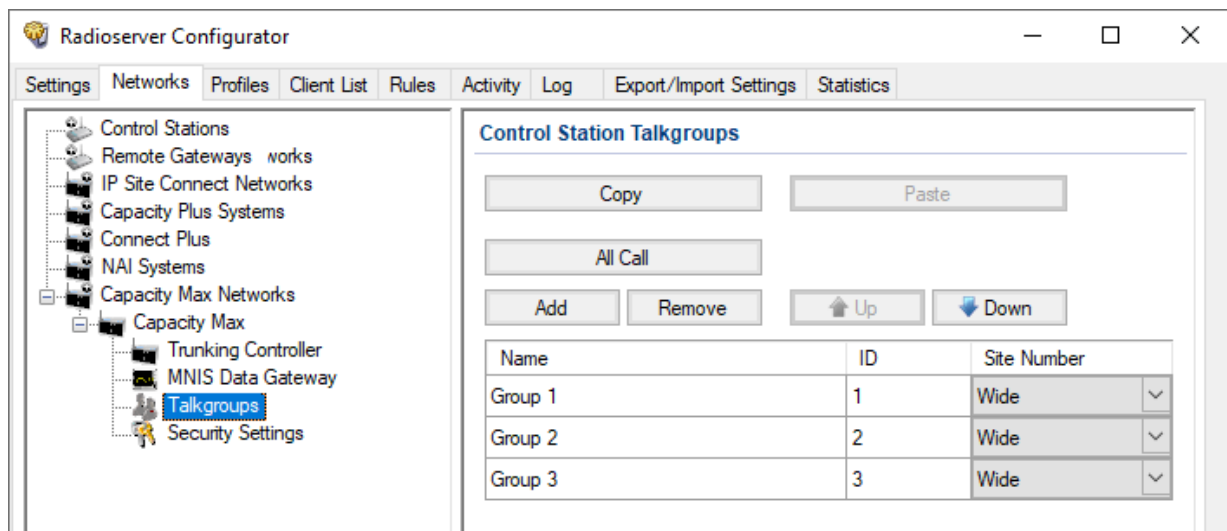



3. (Optional) In the right pane, click **Add** to add a new talkgroup.
4. Edit the desired talkgroup:
 - a. In the table, in the **Name** column, double-click the current talkgroup name, and then type the talkgroup name.
 - b. In the same row, in the **ID** column, double-click the default ID, and then type the talkgroup ID.

NOTE

For talkgroups, the option in the **Site Number** column is always equal to *Wide* and cannot be changed.

5. (Optional) Using **Up** and **Down** buttons, reorder rows in the table.
6. To save changes, at the bottom of the SmartPTT Radioserver Configurator window, click **Save Configuration** ().

Postrequisites:

To apply changes immediately, at the bottom of the SmartPTT Radioserver Configurator window, click **Start** () or **Restart** ().

5.6 Connect Plus

Connect Plus is a digital (DMR) trunked radio system. It is a multisite system (provides great RF coverage) that hosts up to 2900 radios per site and provides up to 29 simultaneous voice calls per site. For details on the system and its capabilities, see [MOTOTRBO™ Connect Plus](#) on the Motorola Solutions website.

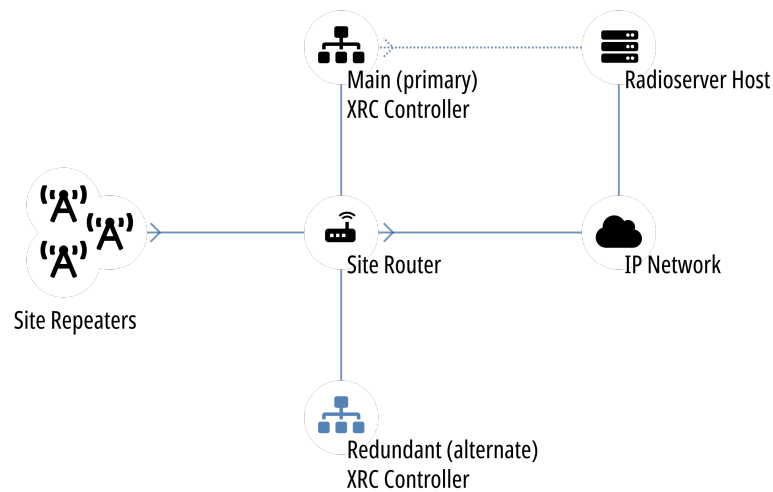

Each site hosts up to 15 repeaters controlled by XRC controller. Controller provides channel management and dispatch subsystems integration to the site. For inter-site and system-wide transmissions, controller accesses another XRC controller (on another site) and provides all the information to it over IP.

SmartPTT must be connected to at least one XRC controller of the system. If a site hosts two controllers (main and alternate), SmartPTT must be connected to the main controller only. It does **not** support the connection to alternate/redundant XRC controllers.

To increase the system connection reliability, SmartPTT can be connected to multiple XRC controllers at once. In this case, if one controller becomes unavailable, SmartPTT will automatically connect to another controller.

5.6.1 SmartPTT Features in Connect Plus

Connect Plus provides the following features to SmartPTT:

- Information on radio presence in the network (ARS).
- Radio location updates (includes revert channel support).
- Text messaging and job ticketing.

Important

Connect Plus does **not** provide voice calls and radio commands to SmartPTT.

Important

Connect Plus does **not** support over-the-radio telemetry and over-the-radio remote control.

For Connect Plus, SmartPTT provides the following features:

- Simultaneous connection to multiple Connect Plus systems.
- Event logging.

- Rules configuration.

For network monitoring, the following features are provided:

- Network device monitoring over SNMP.
- Over-the-air traffic monitoring (without splitting by radio channels).
- Network topology visualization.

NOTE

SmartPTT does **not** show on-site/fielded radios on the topology diagram.

- Statistical information gathering (system performance, alarm statistics), reports generation.

5.6.2 Connect Plus Configuration

SmartPTT connection to the Connect Plus requires the following:

- Radio system compliance with the planning requirements
- Additional radio devices configuration.
- Dispatch software configuration.

Planning Requirements

To support SmartPTT connection, the radio system must comply with the following requirements:

- All radios and repeaters must have the same CAI IDs and CAI Group IDs.
- At least one repeater radio ID must be unused.
- At least one radio ID must be unused.
- Router that connects XRC controller and radioserver (if available) must support Network Address Translation (NAT).
- Router that connects XRT gateways and radioserver (if available) must support NAT.
- Security key IDs and values must be known to SmartPTT configuration engineers since MOTOTRBO software and firmware hides them immediately after the configuration and does **not** provide tools to view them.

Additional Radio Devices Configuration

To support SmartPTT connection to the radio system, the following actions must be performed:

- In each XRC controller, new console users must be created:
 - Dispatch subsystem (radioserver).
 - *(Optional)* Individual dispatchers (operators).
- If XRC controllers and radioserver are connected over the router, network address translation must be configured for all XRC services that will be used by radioserver.

If you need assistance in the MOTOTRBO devices configuration, contact Motorola Solutions representatives in your region.

SmartPTT Configuration

To configure SmartPTT connection to Connect Plus, the following actions must be performed:

- General connection parameters must be configured. For details, see [Adding and Editing Connect Plus](#).
- XRC controller connection must be configured. For details, see [Adding and Editing XRC Controllers](#).
- List of talkgroups must be configured. For details, see [Adding and Editing Talkgroups in Connect Plus](#).

5.6.2.1 Adding and Editing Connect Plus

Follow the procedure to add a new or edit an existing Connect Plus Connection.

Prerequisites:

- Install SmartPTT license that allows Connect Plus connection. For details, see [Installing License](#).
- From configuration files of XRC controllers, obtain the following data:
 - Console User ID for a radioserver.
 - Repeater Radio ID for a radioserver.
- Determine IP address of the radioserver that will be used to connect to the system.

Procedure:

1. In SmartPTT Radioserver Configurator, open the **Networks** tab.
2. In the left pane, perform the following actions:

To add a new network,

right-click the **Connect Plus** node, and then select **Add**.

To edit an existing network,

expand the **Connect Plus** node, and then click the desired node.

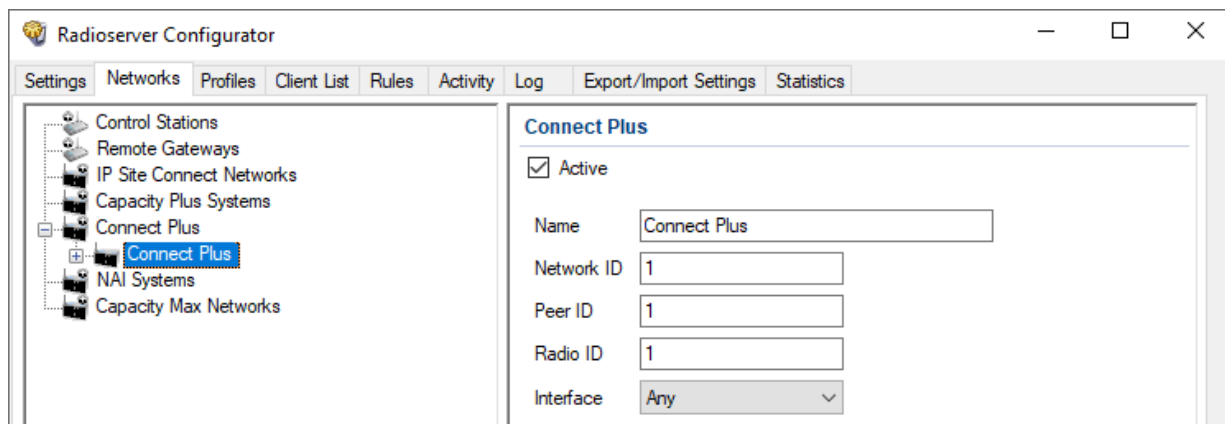

Connection settings appear in the right pane.



3. In the right pane, select the **Active** check box.
4. In the **Name** field, type the radio network name.
5. Leave the value in the **Network ID** field unchanged.
6. In the **Peer ID** field, type the Repeater Radio ID for a radioserver.
7. In the **Radio ID** field, type the Radio ID for radioserver.
8. From the **Interface** list, select one of the following options:

To use any of the active IP addresses of the computer,	select <i>Any</i> .
To use the fixed IP address of the computer,	select the desired address.
9. To save changes, at the bottom of the SmartPTT Radioserver Configurator window, click **Save Configuration** ().

Postrequisites:

- Configure XRC controller connection. For details, see [Adding and Editing XRC Controllers](#).
- Configure talkgroups. For details, see [Adding and Editing Talkgroups in Connect Plus](#).
- To apply changes immediately, at the bottom of the SmartPTT Radioserver Configurator window, click **Start** () or **Restart** ().

5.6.2.2 Adding and Editing XRC Controllers

Follow the procedure to add a new or edit an existing connection to the main/primary site controllers (XRC controllers) of the Connect Plus system.

Prerequisites:

- Add and configure the Connect Plus connection. For details, see [Adding and Editing Connect Plus](#).
- From the controller configuration files, obtain the following data:
 - Presence notification service (ARS) port number.
 - Location service port number.
 - Port number of the text message service.
 - *(Optional)* Port number of the network device monitoring service.
- Determine the radioserver port number used to access the services.

Important

Each service of each XRC controller requires the unique port number.

- If the controller and a radioserver are connected over the router that supports Network Address Translation (NAT), obtain the router IP address that is translated to the controller IP address.

Procedure:

1. In SmartPTT Radioserver Configurator, open the **Networks** tab.
2. In the left pane of the tab, expand **Connect Plus** → **<network name>**.
3. Perform one of the following actions:

To add a new XRC controller,

right-click the **XRC Controllers** node, and then select **Add**.

To edit an existing XRC controller connection,

expand the **XRC Controllers** node, and then click the desired node.

The controller connection settings appear in the right pane.

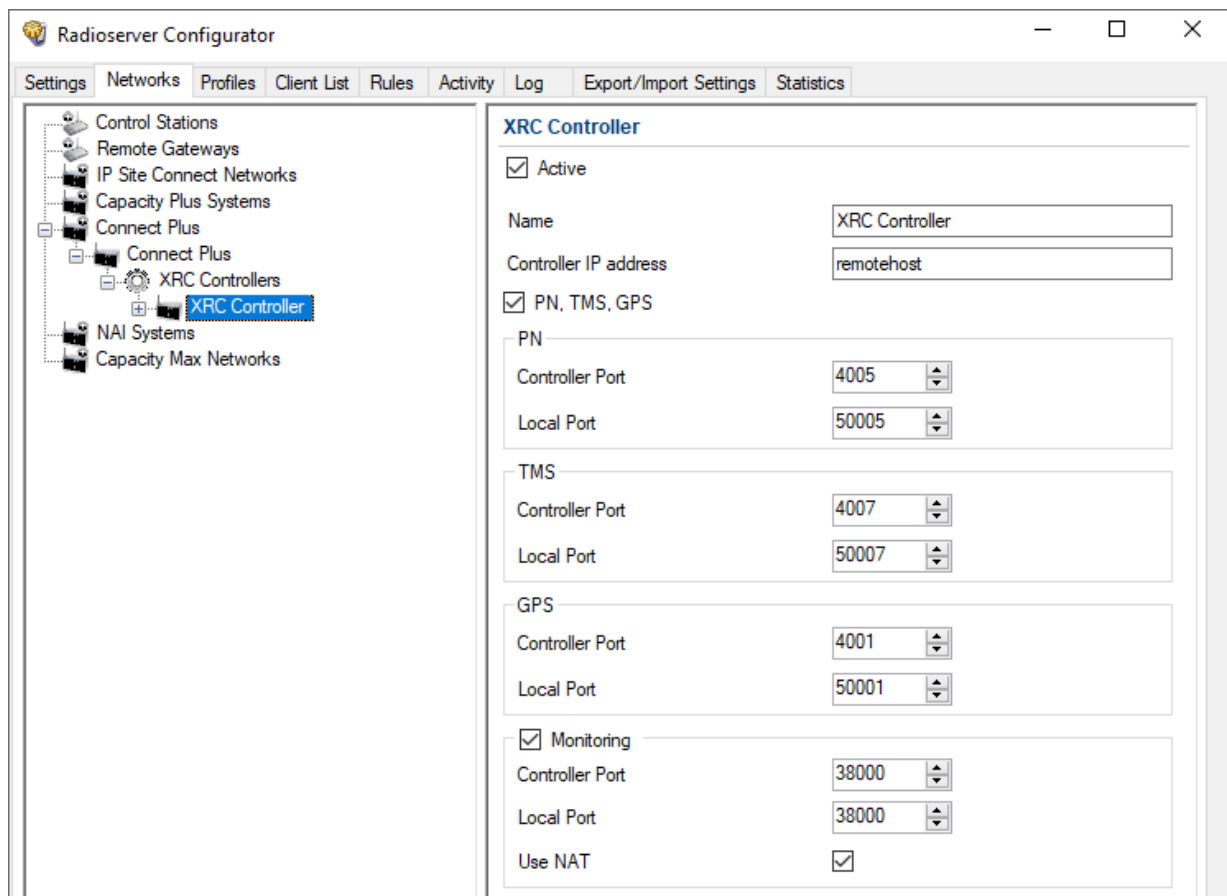

4. In the right pane, select the **Active** check box.
5. In the **Name** field, type the controller name that will be used as the name of the corresponding Location element on the **Network Configuration** tab.
6. In the Controller IP address field, type the IP address of the controller or router that provide access to the controller. Input format is `<IP address in dot-decimal notation>`.
7. Select the **PN, TMS, GPS** check box to allow connection configuration to the controller services.
8. Configure the controller services connection:

To connect to the radio registration service (ARS/DDMS/PN),

perform the following actions:

1. In the **PN** area, in the **Controller Port** field, enter the corresponding controller port number.
 2. In the same area, in the **Local Port** area, enter the radioserver port number.
-

To connect to the text message service,

perform the following actions:

1. In the **TMS** area, in the **Controller Port** field, enter the controller port number that is related to TMS.
 2. In the same area, in the **Local Port** area, enter the radioserver port number.
-

To connect to the radio location service,

perform the following actions:

1. In the **GPS** area, in the **Controller Port** field, enter the corresponding controller port number.
 2. In the same area, in the **Local Port** area, enter the radioserver port number.
-



To connect to the network device monitoring service,

perform the following actions:

1. Select the **Monitoring** check box.
 2. In the **Monitoring** area, in the **Controller Port** field, enter the corresponding controller port number.
 3. In the same area, in the **Local Port** area, enter the radioserver port number.
 4. Select the **Use NAT** check box if a radioserver connects to the controller over the router with active NAT.
-

9. To save changes, at the bottom of the SmartPTT Radioserver Configurator window, click **Save Configuration** ().

Postrequisites:

- Configure talkgroups. For details, see [Adding and Editing Talkgroups in Connect Plus](#).
 - Configure network device monitoring.
 - To apply changes immediately, at the bottom of the SmartPTT Radioserver Configurator window, click **Start** () or **Restart** ().
-

5.6.2.3 Adding and Editing Talkgroups in Connect Plus

Follow the procedure to edit the list of talkgroups that are configured in the XRC controller configuration file.

Prerequisites:

- From the XRC controller configuration file, obtain the list of talkgroup IDs.
- Add and configure SmartPTT connection to all the desired XRC controllers. For details, see [Adding and Editing XRC Controllers](#).

Procedure:

1. In SmartPTT Radioserver Configurator, open the **Networks** tab.
2. In the left pane, expand **Connect Plus** → **XRC Controllers** → **<controller name>**, and then click **Talkgroups**. The list of talkgroups appear in the right pane.

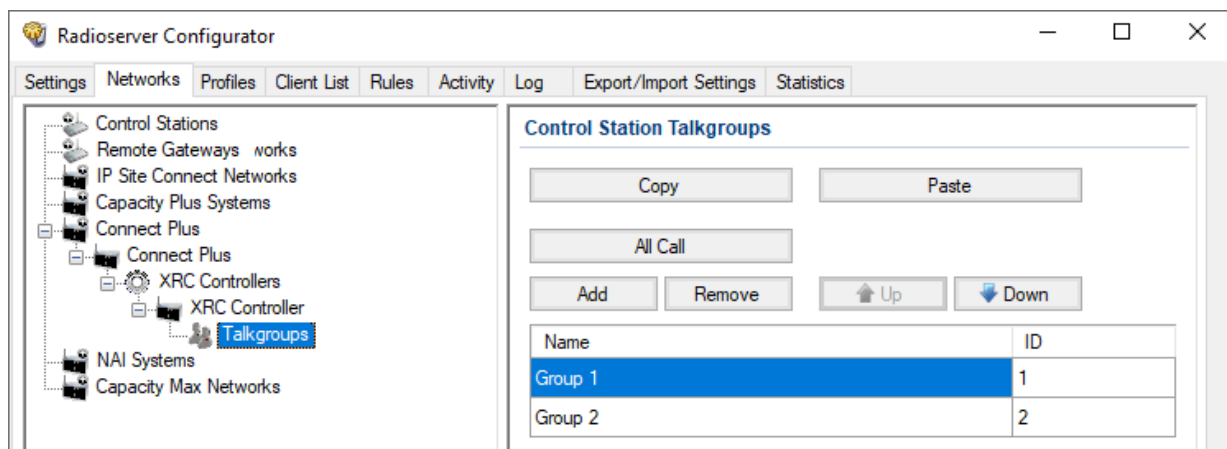

3. In the right pane, perform one of the following actions:

To add a new talkgroup,



click **Add**.

To edit an existing talkgroup,

proceed to the next step of the procedure.

4. In the desired table entry, in the **Name** column, double-click the current name, and then type the desired name.
5. In the same entry, in the **ID** column, double-click the current ID and then type the desired ID.
6. (Optional) Using **Up** and **Down** buttons, reorder rows in the table.
7. To save changes, at the bottom of the SmartPTT Radioserver Configurator window, click **Save Configuration** ().

Postrequisites:

- If talkgroups are configured equally in several XRC controllers, copy them to the corresponding controller lists. For details, see [Copying Talkgroups Between Controllers](#).
- To apply changes immediately, at the bottom of the SmartPTT Radioserver Configurator window, click **Start** () or **Restart** ().

5.6.2.3.1 Copying Talkgroups Between Controllers

Follow the procedure to copy talkgroup list from an XRC controller to another controller within SmartPTT. The procedure is valid if several controllers have equal or slightly different lists of groups.

Prerequisites:

- Configure SmartPTT connection to multiple XRC controllers. For details, see [Adding and Editing XRC Controllers](#).
- Ensure that controller lists of talkgroups are equal or slightly different.

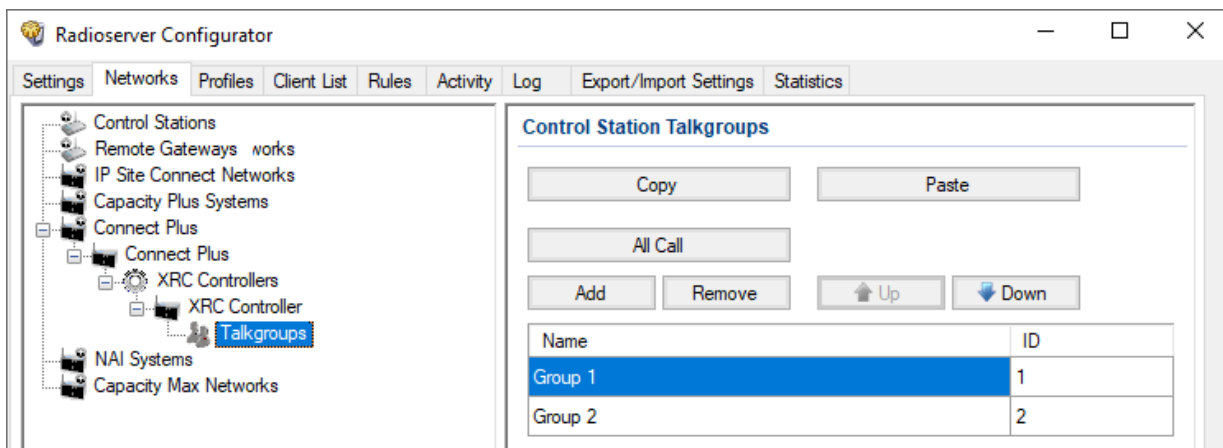

Procedure:

1. In SmartPTT Radioserver Configurator, open the **Networks** tab.
2. In the left pane, expand **Connect Plus** → **XRC Controllers** → **<controller name>**, and then click **Talkgroups**. The list of talkgroups appears in the right pane.



3. In the right pane of the tab, click **Copy** to copy the list of talkgroups to the SmartPTT Radioserver Configurator clipboard.
4. In the left pane of the tab, under the **XRC Controllers** node, expand **<other controller name>**, and then click **Talkgroups**.
5. In the right pane, click **Paste**.
6. To save changes, at the bottom of the SmartPTT Radioserver Configurator window, click **Save Configuration** ().

Postrequisites:

- To apply changes immediately, at the bottom of the SmartPTT Radioserver Configurator window, click **Start** () or **Restart** ().
- (Optional) Edit the copied list of talkgroups. For details, see [Adding and Editing Talkgroups in Connect Plus](#).

5.6.3 Connect Plus Glossary

This section provides interpretations for various terms used in SmartPTT to describe the Connect Plus connection and configuration. The terms may slightly differ from those in the Connect Plus documentation. If you need more information, submit a request to [SmartPTT Technical Support Center](#).

Control Channel

Specific time slot of the specific site repeater (logical site channel) that is used by radios as a reference channel. It is used to deliver commands and notifications including the channel selection for transmission reception and/or initiation.

Presence Notifier (PN)

Radio network service that provides information about radio registration in the system and availability for transmissions. It is synonymous to ARS (automatic registration service) and similar to DDMS (device discovery and mobility service).

5.7 Universal SmartPTT Configuration

Current section provides information on SmartPTT configuration that can be implemented for various radio systems. This information includes the following:

- Configuration of the MNIS access. For details, see [Configuring MNIS Data Gateway](#).
- Configuration of the DDMS access. For details, see [Configuring DDMS Connection](#).
- Configuration of the SmartPTT MNIS Data Gateway Relay connection. For details, see [Configuring SmartPTT MNIS Data Gateway Relay](#).

5.7.1 Configuring DDMS Connection

Follow the procedure to connect SmartPTT Radioserver to the DDMS service.

Prerequisites:

- From the MNIS Configuration Utility, obtain the DDMS host IP address.
- From the DDMS Configuration Utility, obtain the watcher port number (value in the **PortWatcher** field).

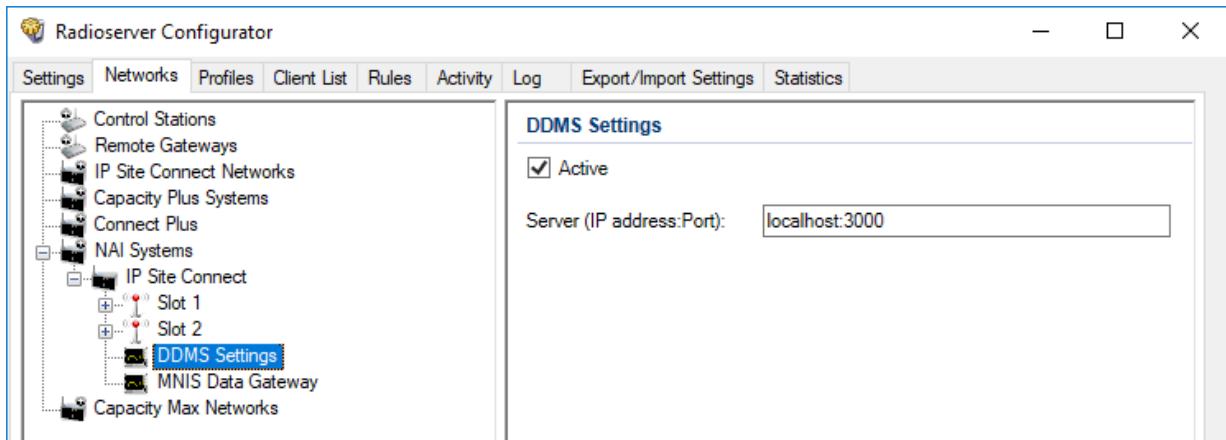

Procedure:

1. In SmartPTT Radioserver Configurator, open the **Networks** tab.
2. In the left pane of the tab, expand **NAI Systems** → <system name>, and then select **DDMS Settings**. The DDMS connection settings appear in the right pane.



3. In the right pane, select the **Active** check box.
4. In the **Server (IP address:Port)** field, type DDMS host IP address and watcher port number. Input format is <IP address in dot-decimal notation>:<port number>.
5. (Optional) If available, select the **DDMS Mode Control** check box to establish dependence of the redundant server DDMS activity from the DDMS activity of the primary server.
6. To save changes, at the bottom of the SmartPTT Radioserver Configurator window, click **Save Configuration** ().

Postrequisites:

To apply changes immediately, at the bottom of the SmartPTT Radioserver Configurator window, click **Start** () or **Restart** ().

5.7.2 Configuring MNIS Data Gateway

Follow the procedure to connect SmartPTT Radioserver to the MNIS service.

The procedure is **not** applicable to Capacity Max. For applicable procedure, see [Connecting to Data Gateways](#).

Prerequisites:

- Determine if the MNIS service is installed on the current or another computer.
- From the MNIS Configuration Utility, obtain the following information:
 - MNIS Tunnel IP and TCP port of the control interface.
 - MNIS ports used for different types of data.
- If MNIS is installed on another computer, configure SmartPTT MNIS Data Gateway Relay on that computer. For details, see [Configuring SmartPTT MNIS Data Gateway Relay](#).

Procedure:

1. In SmartPTT Radioserver Configurator, open the **Networks** tab.
2. Access data gateway settings:
 - a. On the tab, in the left pane, expand **NAI Systems**, and then select **<system name>**.
 - b. In the right pane, select the **Data Transmission** check box, or ensure that it is selected.
 - c. In the left pane, expand **<system name>**, and then select **MNIS Data Gateway**.
The data gateway settings appear in the right pane.

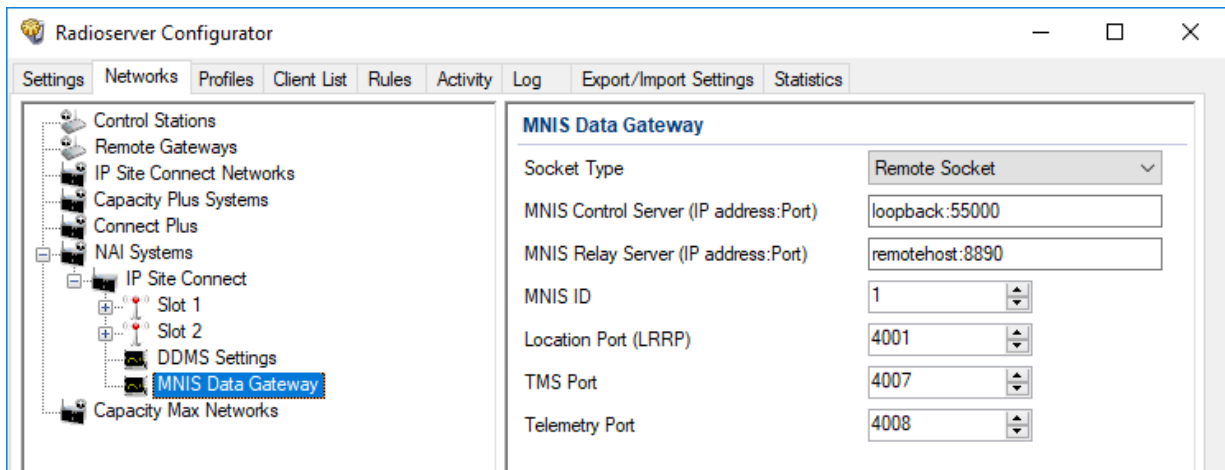

3. Connect SmartPTT Radioserver to the MNIS service:

If MNIS is installed on the current computer,

perform the following actions:

1. In the right pane, from the **Socket Type** list, select *Local Socket*.
2. From the **Interface** list, select the MNIS Tunnel IP address.
The default MNIS Tunnel IP is *192.168.56.1*.
3. In the **MNIS Control Server** field, type **<SmartPTT Radioserver IP>:<MNIS Control Interface TCP Port>**.



If MNIS is installed on another computer,,

perform the following actions:

1. In the right pane, from the **Socket Type** list, select *Remote Socket*.
2. In the **MNIS Control Server** field, type **<MNIS host IP>:<MNIS Control Interface TCP Port>**.
3. In the **MNIS Relay Server** field, type **<MNIS host IP>:<SmartPTT MNIS Data Gateway Relay Port>**.

4. In the **MNIS ID** field, enter MNIS ID.
5. In the **Location Port (LRRP)** field, enter the MNIS port used to provide the outdoor coordinates using the LRRP protocol.
6. In the **TMS Port** field, enter the MNIS port used to receive and send text messages.
7. In the **Telemetry Port** field, enter the MNIS port used for data acquisition and remote control commands.
8. To save changes, at the bottom of the SmartPTT Radioserver Configurator window, click **Save Configuration** ().

Postrequisites:

To apply changes immediately, at the bottom of the SmartPTT Radioserver Configurator window, click **Start** () or **Restart** ().

5.7.3 Configuring SmartPTT MNIS Data Gateway Relay

Follow the procedure to configure SmartPTT MNIS Data Gateway Relay service. The service forwards network traffic between the virtual network interface (tunnel) of the MNIS service and the MNIS host interface. It is required if MNIS is hosted on the computer that is different from radioserver.

Prerequisites:

Install the service on the MNIS host.

Procedure:

1. Start the service configurator
2. In the window that appears, from the **MNIS Interface** list, select the MNIS Tunnel IP address.

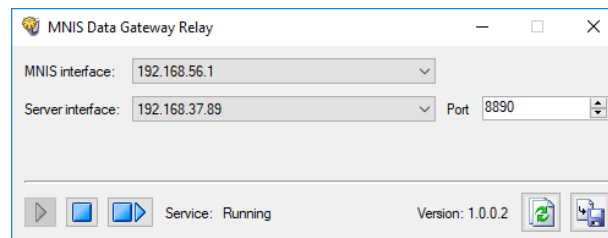

3. Perform one of the following actions:

To forward SmartPTT Radioserver requests and responses only for the specific IP address of the MNIS host,

from the **Server interface** list, select the desired IP address.

To forward SmartPTT Radioserver requests and responses for any IP address of the MNIS host,

from the **Server interface** list, select *Any*.

4. From the **Server interface** list, select the computer IP address.
5. In the **Port** field, type the free UDP port of the computer (default port is 8890).
6. To save changes, at the bottom of the Relay window, click **Save Configuration** ().

Postrequisites:

To apply changes immediately, at the bottom of the Relay window, click **Start** (▶) or **Restart** (◀▶).

5.8 MOTOTRBO Control Stations

SmartPTT supports MOTOTRBO control stations, MOTOTRBO-compliant mobile or base radios that act as access points to the radio network.

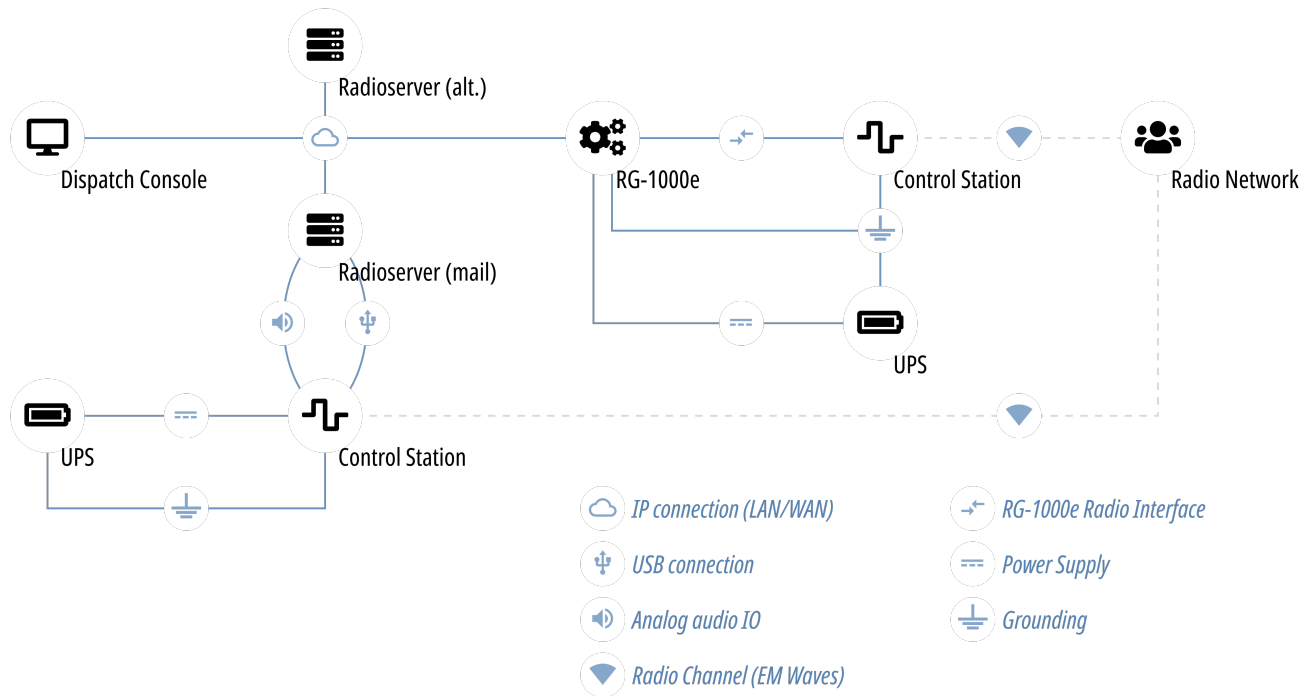

In SmartPTT, MOTOTRBO control stations are intended for the following purposes:

- Direct communication with other radios.
- Capacity Plus access over the hybrid interface. For details, see [Capacity Plus](#).

If you have questions on control stations application in other repeater systems, contact Elcomplus LLC representatives in your region.

SmartPTT supports the following interfaces for MOTOTRBO control stations connection:

- Digital-and-analog interface (USB+audio). For details, see [MOTOTRBO Station Access over USB+Audio](#).
- Over the RG-1000e radio gateway. For details, see [MOTOTRBO Station Access over RG-1000e](#).

Using MOTOTRBO radios as control stations implies that they are **not** operated directly. This includes the following:

- No person must switch channels on the control station using Control Head buttons or other controls.
- No person must transmit from the radio using Control Head buttons or handsets.

Violation of such requirements results in the data desynchronization between SmartPTT and a control station.

5.8.1 Control Station Features

MOTOTRBO control stations provide the following features to SmartPTT:

- Direct communication with digital radios.
- Limited support for analog radio systems (MDC-1200 and Select 5). For details, submit a request to the [SmartPTT Technical Support Center](#).
- Radios registration (includes on-activity registration).
- Incoming and outgoing voice calls (group and private calls).
- Incoming emergency alarms and calls.
- Voice encryption and decryption.
- Radio location reports reception.
- Text messages and job tickets.
- Telemetry data acquisition and remote control using on-site radios.

Based on provided features, SmartPTT implements the following features:

- Simultaneous connection to multiple control stations.
- Phone calls.
- Voice integration with other radio systems using cross patches, bridging, and conference calls.
- Events and voice logging.
- Rules configuration.
- Control station accessibility over the Server API. For details, see [Third-Party Apps](#).

For station control purposes, SmartPTT provides the channel selection feature for control stations.

For network monitoring purposes, SmartPTT provides the following features:

- Connection monitoring between radioserver and the control station.
- Supplemental network devices monitoring (UPS, switches etc.).
- Automatic alarm notifications.
- Radio channel monitoring (may be referred to as “air monitoring”).
- Availability on the topology diagram.

NOTE

SmartPTT does **not** show on-site/fielded radios on the topology diagram.

5.8.2 MOTOTRBO Stations Configuration

Configuration of control stations and fielded radios requires the following:

- Compliance with planning requirements. For details, see “Planning Requirements” [below](#).
- Additional control station configuration. For details, see “Control Station Configuration” [below](#).
- Additional digital radios configuration. For details, see “Digital Radios Configuration” [below](#).

Important

Information below provides the minimum required changes in radio equipment settings. It is **not** sufficient for operation. For configuration assistance, submit a request to [SmartPTT Technical Support Center](#).

Planning Requirements

To support the direct mode communication, all radios (including control stations) must comply with the following requirements:

- All radios (including control stations) must have unique Radio IDs.
- All radios (including control stations) must have equal radio network IDs (CAI ID) and group ID in the radio network (CAI Group ID).
- All radios (including control stations) must use equal security keys.
- All radios (including control stations) must have equal set of properly configured channels. Proper channel configuration includes the following aspects:
 - Receive and transmit frequencies.
 - Default groups on each channel.
 - Security systems.

Control Station Configuration

To configure mobile/base radios to operate as control stations, their codeplugs must be modified in the following way:

- Private calls must be allowed.
- Radio network services must be activated:
 - Location (GNSS) service.
 - Text message service.
- Control station interface must be configured:
 - Voice and non-voice information must be routed over the cable.
 - Information forwarding to PC must be activated.
- Control station channels must be configured:
 - Each digital channel must have a different default talkgroup

- *(Optional)* One of digital channels must have the All Call as a default group.
- Emergency alarm acknowledgment must be activated on each digital radio channel.
- *(Optional)* Voice/transmit interruption must be configured. It is recommended to allow voice/transmit interruption for control station despite of the color code or channel accessibility.

Digital Radios Configuration

To configure digital radios, their codeplugs must be modified in the following way:

- They must send registration reports to the control station Radio ID.
- They must send their location reports to the control station Radio ID.
- Their emergency group must be the default talkgroup of the control station.

5.8.3 MOTOTRBO Station Access over USB+Audio

To connect a MOTOTRBO control station to the radioserver host, the following elements must be connected to each other:

- Control station must be connected to the power supply that is **disconnected** from the power system.
- Control station must be connected to the radioserver host using Elcomplus LLC cable.
- Power supply must be connected to the power system.

WARNING

Power connection may result in the unintended personnel injury or equipment damage. The connection must be performed with a qualified engineer who have the corresponding license.

To configure the control station connection to the radioserver, the following actions must be performed:

- SmartPTT license with MOTOTRBO control stations permission must be installed. For details, see [Installing License](#).
- Radioserver must be connected to the control station. For details, see [Adding and Editing MOTOTRBO Control Stations](#).
- *(Optional)* 5-tone telegrams must be configured.
- Talkgroups and All Call must be added. For details, see [Adding and Editing MOTOTRBO Groups](#).
- Control station channels must be configured. For details, see [Adding and Editing MOTOTRBO Channels](#).
- Voice processing must be configured. For details, see [Configuring MOTOTRBO Audio Settings](#).

5.8.3.1 Adding and Editing MOTOTRBO Control Stations

Follow the procedure to add a new or edit an existing connection to the local MOTOTRBO control station.

Prerequisites:

- Ensure that the control station is connected to the SmartPTT Radioserver host using the dedicated Elcomplus LLC cable, connected to the power supply, and turned on.
- Ensure that SmartPTT has the license that unlocks the use of MOTOTRBO control station. For details, see [Viewing License Items](#).
- From the control station codeplug, obtain the following information:
 - Radio ID, CAI network ID, and CAI Group ID.
 - Control station ports used to receive and transmit various data types.
 - Transmit interruption parameters.
 - Location provision settings that depend on data transmission settings on channel.

Procedure:

1. In SmartPTT Radioserver Configurator, open the **Networks** tab.
2. In the left pane, perform one of the following actions:

To add a new connection,

perform the following actions:

1. Right-click **Control Stations**.
2. Point to **Add**, and then select **MOTOTRBO control station**.

To edit an existing connection,

expand **Control Stations**, and then select the desired control station.

The control station parameters appear in the right pane.

The screenshot shows the 'Radioserver Configurator' application window. On the left is a tree view with 'Control Stations' selected. The main pane is titled 'MOTOTRBO Control Station' and contains the following configuration options:

- Active
- Name: Control Station
- Network ID: 2
- Control station IP address: 192.168.10.1
- Local interface: 192.168.10.2
- Radio ID: 16448250
- CAI Network: 12
- CAI Network for Groups: 225
- Data Channel
- Phone Calls
- GPS
- ARS Port: 4005
- TMS Port: 4007
- Telemetry Service Port: 4008
- TX Criteria: Channel Free
- Analog Call Hangtime, ms: 3000
- Options:
 - GPS Transmission Mode: Data
 - Register radios when receiving GPS coordinates
- 5 Tone signaling
- Buttons: Add, Delete
- Table:

System	PTT ID Telegram Number

3. In the right pane, select the **Active** check box to unlock control station settings.
4. In the **Name** field, type the control station name.
5. Leave the value in the **Network ID** field unchanged.
6. In the **Control station IP address** field, type the IP address of the local network interface associated with the connected control station.
7. Leave the value in the **Local interface** field unchanged.
8. Type the control station identification parameters:
 - a. In the **Radio ID** field, type the control station ID in the decimal notation.
 - b. In the **CAI Network** field, type the ID of the CAI network that is set in the control station codeplug.
 - c. In the **CAI Network for Groups** field, type the ID of the CAI network for groups that is set in the control station codeplug.

9. Select the **Data Channel** check box if the control station is used to receive location coordinates from other radio only.

Important

All other parameters must be configured only if the **Data Channel** check box is cleared.

10. Select the **Phone Calls** check box to allow other radios to receive and initiate phone calls over the control station.
11. Configure data transmission over the control station:

To receive location updates and information on movements beyond the RF Coverage zones,

select the **GPS** check box.

Important

SmartPTT assumes that the control station always receives location information to the port.

To receive information about radio presented in the radio network,

perform the following actions:

1. Select the **ARS** check box.
2. To the right of the check box, in the field, enter the port number used to receive the data.

To support text messages and job tickets in the radio network,

perform the following actions:

1. Select the **TMS** check box.
2. To the right of the check box, in the field, enter the port number used to receive and transmit the data.

To receive telemetry data and send telemetry commands,

perform the following actions:

1. Select the **Telemetry Service** check box.
2. To the right of the check box, in the field, enter the port number used to receive and transmit the data.

12. From the **TX Criteria** list, select one of the following options:

If the control station is configured to transmit only when no other transmissions is detected over the radio channel,

select *Channel Free*.

If the control station is configured to notify other radios on transmissions interruption,

select *Tx Interrupt*.

If the control station is configured to completely ignore other transmission over the radio channel,

select *Always*.

Important

SmartPTT does not support color code criteria for outgoing transmissions.

13. In the **Analog Call Hangtime, ms** field, enter the maximum time interval between transmissions over analog channels that will be considered as transmissions within the same call in SmartPTT.
14. From the **GPS Transmission Mode** list, select one of the following options:



If all the digital channels support both CSBK data and enhanced GNSS,	select <i>Enhanced CSBK</i> .
If all the digital channels support CSBK data, and do not support Enhanced GNSS,	select <i>CSBK</i> .
If digital channels have different settings,	select <i>Data</i> .
15. Select the **Register radios when receiving GPS coordinates** check box to allow SmartPTT Radioserver register radios on the control station when it receives their GPS coordinates.
16. Clear the **5 Tone signaling** check box.

Important

For information on five-tone signaling support in SmartPTT, submit a request to the [SmartPTT Technical Support Center](#).

17. To save changes, at the bottom of the SmartPTT Radioserver Configurator window, click **Save Configuration** ().

Postrequisites:

- Configure groups. For details, see [Adding and Editing MOTOTRBO Groups](#).
- Configure control station channels. For details, see [Adding and Editing MOTOTRBO Channels](#).
- Configure audio settings. For details, see [Configuring MOTOTRBO Audio Settings](#).
- To apply changes immediately, at the bottom of the SmartPTT Radioserver Configurator window, click **Start** () or **Restart** ().

5.8.3.2 Adding and Editing MOTOTRBO Groups

Follow the procedure to add new or edit existing talkgroups and All Call entries that will be available to SmartPTT dispatchers.

Prerequisites:

From the control station codeplug, obtain talkgroup IDs. To obtain the information, use the compatible MOTOTRBO CPS application.

Procedure:

1. In SmartPTT Radioserver Configurator, open the **Networks** tab.
2. In the left pane, expand **Control Stations** → <your control station>, and then select **Talkgroups**. The list of groups appears in the right pane.

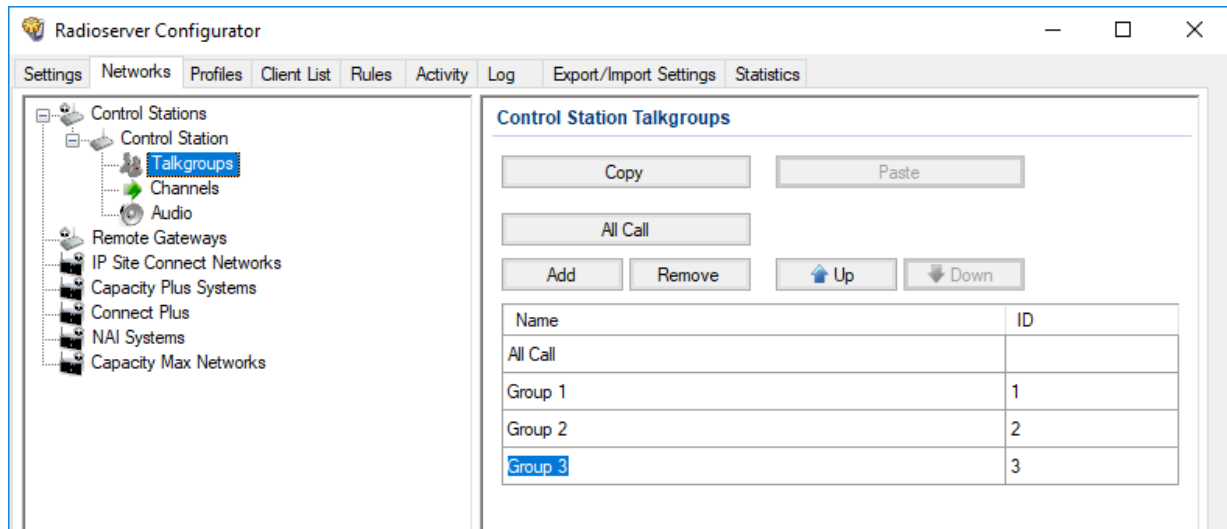

3. In the right pane, perform one of the following actions:

- | | |
|----------------------------|--|
| To add a new talkgroup, | click Add . |
| To add an All Call, | click All Call . |
| To edit an existing entry, | proceed to the next step of the procedure. |

4. In the table, in the desired entry, perform the following actions:



- In the **Name** column, double-click the current name, and then type the desired name.
- In the **ID** column, double-click the current Talkgroup ID, and then type the desired ID.

NOTE

For All Call, no ID is shown.

- (Optional) Using **Up** and **Down** buttons, reorder entries in the table.
- To save changes, at the bottom of the SmartPTT Radioserver Configurator window, click **Save Configuration** ().

Postrequisites:

To apply changes immediately, at the bottom of the SmartPTT Radioserver Configurator window, click **Start** () or **Restart** ().

5.8.3.3 Adding and Editing MOTOTRBO Channels

Follow the procedure to add new or edit existing control station channels.

Prerequisites:

- From the control station codeplug, obtain the following information:
 - List of channels and their identification information (zone IDs and channel IDs).
 - Radio signaling type used on each channel.
 - Channel default contract (talkgroup ID or All Call).

To obtain the information use the compatible MOTOTRBO CPS application.

- Ensure that talkgroups and All Calls are added to SmartPTT Radioserver Configurator. For details, see [Adding and Editing MOTOTRBO Groups](#).
- If required, ensure that the necessary 5-tone telegrams are added to SmartPTT Radioserver Configurator.

Procedure:

1. In SmartPTT Radioserver Configurator, open the **Networks** tab.
2. In the left pane, expand **Control Stations** → **<your control station>**, and then select **Channels**. The list of channels appears in the right pane.

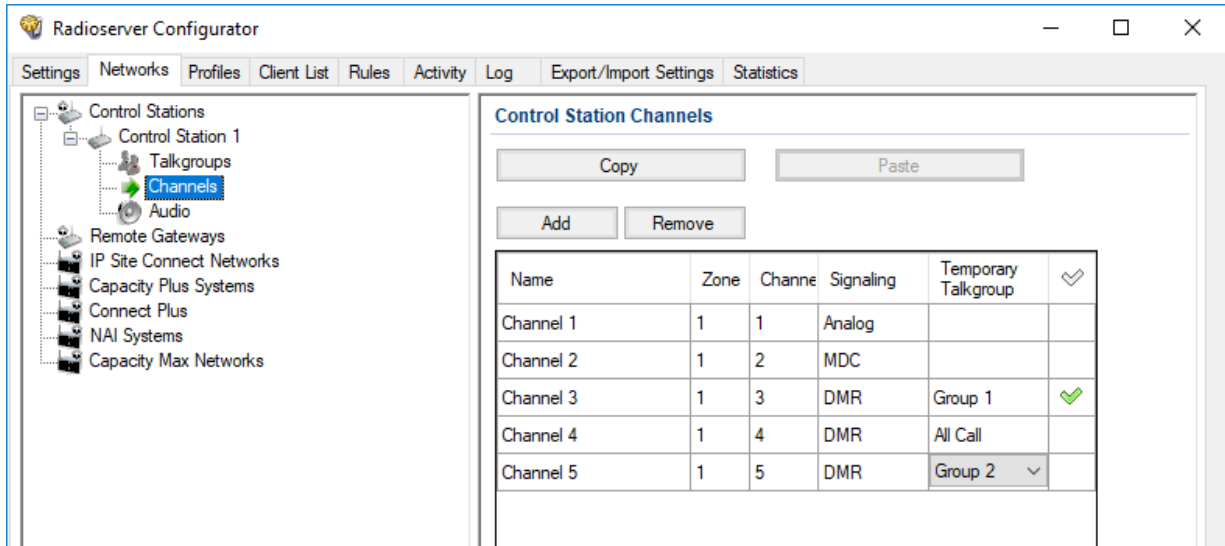

3. In the right pane, perform one of the following actions:

To add a new channel, click **Add**.

To edit an existing entry, proceed to the next step of the procedure.

4. In the table, in the desired entry, perform the following actions:

- a. In the **Name** column, double-click the current channel name, and then type a new name.
- b. In the **Zone** field, double-click the current zone ID, and then type the desired ID.
- c. In the **Channel** column, double-click the current channel ID, and then type the desired ID.
- d. In the **Signaling** column, configure the desired signaling type on the channel:

To configure a digital channel, perform the following actions:

1. From the list, select **DMR**.
2. In the **Temporary Talkgroup** column, from the list, select the desired talkgroup or All Call.

To configure an analog channel, from the list, select the desired option.

- After all channels are configured, in the **Default Channel** (✓) column, select the check box next to the channel that will be selected on the control station each time SmartPTT Radioserver is started or restarted.
- To save changes, at the bottom of the SmartPTT Radioserver Configurator window, click **Save Configuration** ().

Postrequisites:

To apply changes immediately, at the bottom of the SmartPTT Radioserver Configurator window, click **Start** (▶) or **Restart** ().

5.8.3.4 Configuring MOTOTRBO Audio Settings

Follow the procedure to edit audio settings required to receive voice from the control station and send dispatcher voice to it.

Prerequisites:

From the SmartPTT Radioserver host, obtain the identification information on audio inputs and outputs used to connect the control station.

Procedure:

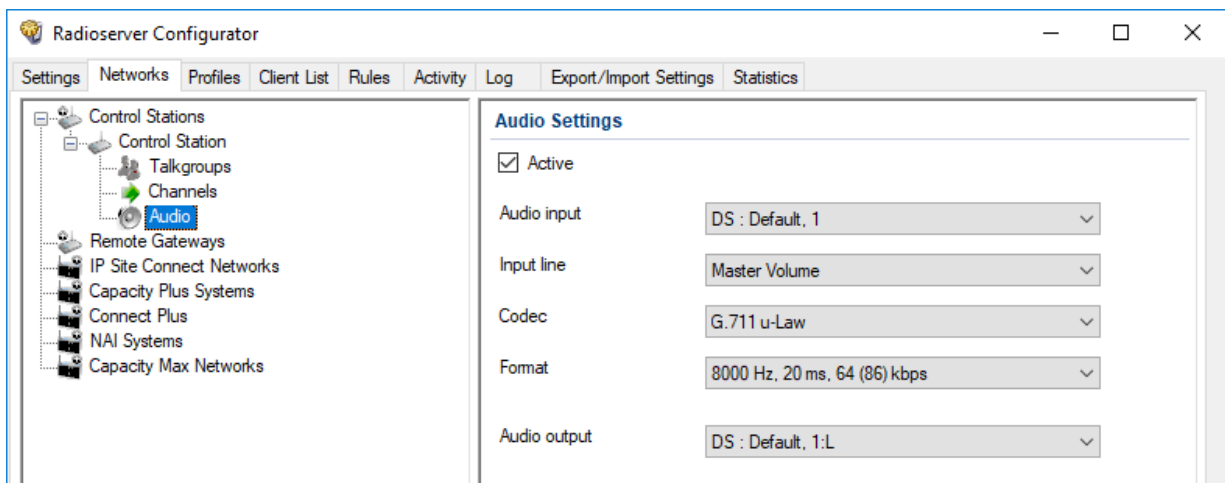

- In SmartPTT Radioserver Configurator, open the **Networks** tab.
- In the left pane, expand **Control Stations** → <your control station>, and then select **Audio**. The audio settings appear in the right pane.



- In the right pane, select the **Active** check box to unlock audio settings.
- From the **Audio** input list, select the proper microphone input.
- Leave the value in the **Input line** unchanged until you are using the sound card with multiple audio processing lines for each input.
- From the **Codec** list, select the desired codec. The recommended options are *G.711 u-Law* and *G.711 A-Law*.
- From the **Format** list, select the codec parameters. The selected option will affect the IP channel loading between SmartPTT Radioserver and SmartPTT Dispatcher.

8. From the **Audio output list**, select the proper speaker output.
9. To save changes, at the bottom of the SmartPTT Radioserver Configurator window, click **Save Configuration** ().

Postrequisites:

To apply changes immediately, at the bottom of the SmartPTT Radioserver Configurator window, click **Start** () or **Restart** ().

5.8.4 MOTOTRBO Station Access over RG-1000e

RG-1000e is a radio gateway device intended to provide the remote access to control stations for SmartPTT. It may also be used for other purposes (like radio system bridging, “distributed repeaters” etc). For details, visit the [SmartPTT RG-1000e](#) webpage of the SmartPTT website.

Additional Features

If MOTOTRBO control station is connected over RG-1000e, it provides the following additional features to SmartPTT:

- Alternate/redundant radioserver support.
- Configurable session initiator.

Using RG-1000e does **not** provide the following features:

- Secure connection between radio gateway and radioserver.
- Location reporting using option boards. For details, see [Location with Option Boards](#).

Radio Gateway Configuration

To configure the gateway to support MOTOTRBO control stations connected over the digital-and-analog interface, the following actions must be performed:

- Control station must be connected to the gateway using Elcomplus LLC cable.
- Power supply and grounding must be configured correctly for control station gateway.

WARNING

Power connection may result in the unintended personnel injury or equipment damage. The connection must be performed with a qualified engineer who have the corresponding license.

- In gateway configuration file, the correct connection mode must be configured:
 - MOTOTRBO radio connection.
 - Control station connection.
- Gateway IP channel association with a physical radio port must be configured.
- *(Optional)* Audio gain/attenuation must be configured on the radio port.

For information on the gateway settings, see the corresponding documentation:

- *RG-1000e Remote Gateway User Guide*

- *CPS RG-1000e User Guide*

For information on the analog connection of the MOTOTRBO control station to the gateway, see [Analog Interfaces](#).

SmartPTT Configuration

To configure the control station connection over RG-1000e to the radioserver, the following actions must be performed:

- SmartPTT license with MOTOTRBO control station permissions must be installed. For details, see [Installing License](#).
- Connection to the control station must be configured. For details, see [Adding and Editing Remote MOTOTRBO](#).
- *(Optional)* 5-tone telegrams must be configured.
- Talkgroups and All Call must be added. For details, see [Adding and Editing Remote MOTOTRBO Groups](#).
- Control station channels must be configured. For details, see [Adding and Editing Remote MOTOTRBO Channels](#).
- Voice processing must be configured. For details, see [Configuring Remote MOTOTRBO Audio Settings](#).

5.8.4.1 Adding and Editing Remote MOTOTRBO

For details, see add a new or edit an existing connection to the remote MOTOTRBO control station.

Prerequisites:

- Ensure that SmartPTT license allows remote control stations access. For details, see [Viewing License Items](#).
- From the control station codeplug, obtain the following information:
 - Radio ID, CAI network ID, and CAI Group ID.
 - Control station ports used to receive and transmit various data types.
 - Transmit interruption parameters.
 - Location provision settings that depend on data transmission settings on channel.
- From the radio gateway codeplug, receive the IP address and port number configured for the desired control station.
- Determine the connection mode to the control station.
- *(Optional)* Determine SmartPTT Radioserver host ports that will be used to receive different data types from the control station.

Procedure:

1. In SmartPTT Radioserver Configurator, open the **Networks** tab.
2. In the left pane, perform one of the following actions:

To add a new connection,

perform the following actions:

1. Right-click **Remote Gateways**, and then click **Add**.
The **<remote gateway name>** node appears.
2. In the right pane, select the **Active** check box to activate connection to the remote gateway.
3. *(Optional)* Type the radio gateway name.
4. In the left pane, right-click the **<remote gateway name>** node, point to **Add**, and then select **Remote MOTOTRBO Control Station**.

To edit an existing connection,

perform the following actions:

1. Expand the **Remote Gateways** node.
2. Expand the desired **<remote gateway name>** node, and then click the desired control station.

The control station parameters appear in the right pane.

The screenshot shows the Radioserver Configurator application window. The left pane displays a tree view of the configuration hierarchy, with 'Remote control station 1' selected under 'Remote Gateways'. The right pane shows the configuration for this station, including fields for Name, Network ID, Connection mode, Control station IP address, Local interface, Local ports, Radio ID, CAI Network, and various service checkboxes.

MOTOTRBO Control Station

Active

Name: Remote control station 1

Network ID: 3

Connection mode: Client

Control station IP address: 192.168.10.1 XCMP port: 30010

Local interface: Any

Local ports

Local Ports Allocation:

Auto Set manually

XCMP: 1024

Audio: 1024

GPS: 1025

TMS: 1026

ARS: 1027

Telemetry Service: 1028

Radio ID: 16448250

CAI Network: 12

CAI Network for Groups: 225

Data Channel

Phone Calls

GPS

ARS Port: 4005

TMS Port: 4007

Telemetry Service Port: 4008

TX Criteria: Channel Free

Analog Call Hangtime, ms: 3000

Options

GPS Transmission Mode: Data

Register radios when receiving GPS coordinates

5 Tone signaling

Add Delete

System PTT ID Telegram Number

3. In the right pane, select the **Active** check box to unlock control station settings.
4. In the **Name** field, type the control station name.
5. Leave the value in the **Network ID** field unchanged.
6. From the **Connection mode** list, select the connection mode to the control station:

To make the RG-1000e act as a client,

perform the following actions:

1. From the **Connection mode** list, select the *Client* mode.
2. In the **Control station IP address** field, type the radio gateway IP address to which the radioserver will be connected.
3. In the **XCMP port** field, enter the port number that the radio gateway will use for connection to the radioserver.

To make the RG-1000e act as a server,

perform the following actions:

1. From the **Connection mode** list, select the *Server* mode.
2. In the **XCMP local port** field, enter the SmartPTT Radioserver port number through which the radio gateway will be connected to SmartPTT Radioserver.

7. From the **Local interface** list, specify the IP address of the radioserver for connection to the radio gateway:

To provide the radioserver ability to select IP address,

select *Any*.

To use a specific IP address,

select the desired IP address from the list.

8. *(Optional)* Set SmartPTT Radioserver host ports for different types of data:

If you want local ports to be set automatically,

select *Auto*.

If you want to set specific local port values,

perform the following actions:

1. Select *Set manually*.
2. If available, in the **XCMP** field, enter the number of the port used to receive commands and service messages from the remote control station, and send commands and service messages to it.
3. In the **Audio** field, enter the number of the port used to receive voice from the remote control station, and send dispatcher voice to it.

4. In the **GPS** field, enter the number of the port used to receive the location updates from radios, and send location update requests to them over the remote control station.
 5. In the **TMS** field, enter the number of the port used to receive text messages from radios over the control station, and send text messages from dispatchers over the remote control station.
 6. In the **ARS** field, enter the number of the port used to receive presence information on radios within the RF coverage zone of the remote control station.
 7. In the **Telemetry Service** field, enter the number of the port used to receive telemetry data over the control stations, and send telemetry commands over the control station.
-
9. Type the control station identification parameters:
 - a. In the **Radio ID** field, type the control station ID in the decimal notation.
 - b. In the **CAI Network** field, type the ID of the CAI network that is set in the control station codeplug.
 - c. In the **CAI Network for Groups** field, type the ID of the CAI network for groups that is set in the control station codeplug.
 10. Select the **Data Channel** check box if the control station is used to receive location coordinates from other radios only.

Important

All other parameters must be configured only if the **Data Channel** check box is cleared.

11. Select the **Phone Calls** check box to allow other radios to receive and initiate phone calls over the control station.
12. Configure data transmission over the control station:

To receive location updates and information on movements beyond the RF Coverage zones,

select the **GPS** check box.

Important

SmartPTT assumes that the control station always receives location information to the port *4001*.

To receive information about radio presence in the network,

perform the following actions:

1. Select the **ARS** check box.
2. To the right of the check box, in the field, enter the port number used to receive the data.

To support text messages and job tickets in the radio network,

perform the following actions:

1. Select the **TMS** check box.
2. To the right of the check box, in the field, enter the port number used to receive and transmit the data.

To receive telemetry data and send telemetry commands,

perform the following actions:

1. Select the **Telemetry Service** check box.
2. To the right of the check box, in the field, enter the port number used to receive and transmit the data.

13. From the **TX Criteria** list, select one of the following options:

If the control station is configured to transmit only when no other transmissions are detected over the radio channel,

select *Channel Free*.

If the control station is configured to notify other radios on interrupting their transmissions,

select *Tx Interrupt*.

If the control station is configured to completely ignore other transmission over the radio channel,

select *Always*.

Important

SmartPTT does not support color code criteria for outgoing transmissions.

14. In the **Analog Call Hangtime** field, enter the maximum time interval between transmissions over analog channels that will be considered as transmissions within the same call in SmartPTT.

15. From the **GPS Transmission Mode** list, select one of the following options:

If all digital channels support both CSBK data and enhanced GNSS,

select *Enhanced CSBK*.

If all digital channels support CSBK data, and do not support Enhanced GNSS,

select *CSBK*.

If digital channels have different settings,

select *Data*.



16. Select the **Register radios when receiving GPS coordinates** check box to allow SmartPTT Radioserver register radios on the control station when it receives their GPS coordinates.
17. If you use the control station in analog radio systems with 5-tone signaling, in the **5 Tone signaling** area, configure 5-tone telegrams.

NOTE

At the moment, support for 5-tone signaling in SmartPTT is carried out in a limited mode, therefore you should contact the [SmartPTT Technical Support Center](#) regarding the use of 5-tone signaling.

18. To save changes, at the bottom of the SmartPTT Radioserver Configurator window, click **Save Configuration** ().

Postrequisites:

- Configure groups. For details, see [Adding and Editing Remote MOTOTRBO Groups](#).
- Configure control station channels. For details, see [Adding and Editing Remote MOTOTRBO Channels](#).
- Configure audio settings. For details, see [Configuring Remote MOTOTRBO Audio Settings](#).
- To apply changes immediately, at the bottom of the SmartPTT Radioserver Configurator window, click **Start** () or **Restart** ().

5.8.4.2 Adding and Editing Remote MOTOTRBO Groups

Follow the procedure to add new or edit existing talkgroups and an All Call entry that will be available to SmartPTT dispatchers.

Prerequisites:

From the remote control station codeplug, obtain talkgroup IDs. To obtain the information, use the compatible MOTOTRBO CPS application.

Procedure:

1. In SmartPTT Radioserver Configurator, open the **Networks** tab.
2. In the left pane, expand **Remote Gateways** → **<remote gateway name>** → **<control station name>**, and then select **Talkgroups**.

The list of groups appears in the right pane.

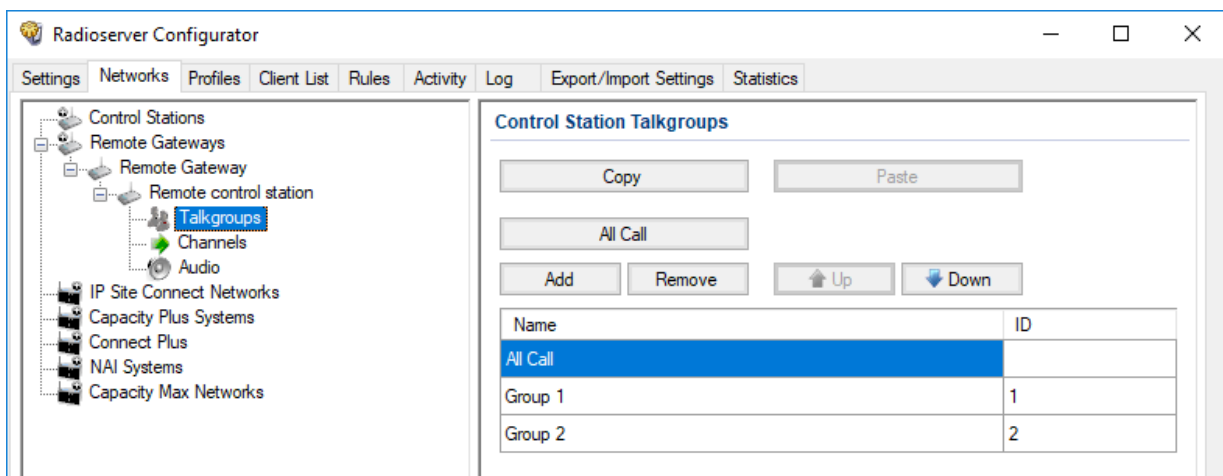

3. In the right pane, perform one of the following actions:

To add a new talkgroup,	click Add .
To add an All Call entry,	click All Call .
To edit an existing entry,	proceed to the next step.



4. In the table, in the desired entry, perform the following actions:
 - a. In the **Name** column, double-click the current name, and then type the desired name.
 - b. In the **ID** column, double-click the current talkgroup ID, and then type the desired ID.

NOTE

For All Call, no ID is shown.

5. (Optional) Using **Up** and **Down** buttons, reorder entries in the table.
6. To save changes, at the bottom of the SmartPTT Radioserver Configurator window, click **Save Configuration** ().

Postrequisites:

To apply changes immediately, at the bottom of the SmartPTT Radioserver Configurator window, click **Start** () or **Restart** ().

5.8.4.3 Adding and Editing Remote MOTOTRBO Channels

For details, see add new or edit existing channels of remote control stations.

Prerequisites:

- From the control station codeplug, obtain the following information:
 - List of channels and their identification information (zone IDs and channel IDs).
 - Radio signaling type used on each channel.
 - Channel default contract (talkgroup ID or All Call).

To obtain the information use the compatible MOTOTRBO CPS application.

- Ensure that talkgroups and All Call are added to SmartPTT Radioserver Configurator. For details, see [Adding and Editing Remote MOTOTRBO Groups](#).
- (Optional) Ensure that the necessary 5-tone telegrams are added to SmartPTT Radioserver Configurator.

Procedure:

1. In SmartPTT Radioserver Configurator, open the **Networks** tab.
2. In the left pane, expand **Remote Gateways** → <remote gateway name> → <control station name>, and then select **Channels**.
The list of channels appears in the right pane.

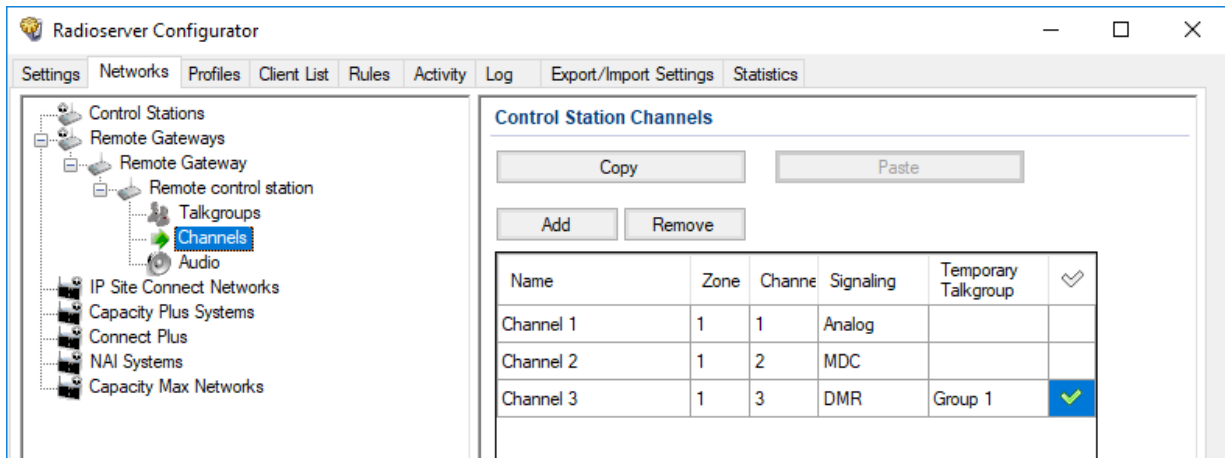

3. In the right pane, perform one of the following actions:

To add a new channel, click **Add**.

To edit an existing entry, proceed to the next step.



4. In the table, in the desired entry, perform the following actions:

- In the **Name** column, double-click the current channel name, and then type a new name.
- In the **Zone** field, double-click the current zone ID, and then type the desired ID.
- In the **Channel** column, double-click the current channel ID, and then type the desired ID.
- From the list in the **Signaling** column, select the radio signaling used on the radio channel or the desired 5-tone telegram.
- From the list in the **Talkgroup** column, select the talkgroup or All Call that is set as default contact on the channel.

5. After all channels are configured, in the **Default Channel (✓)** column, select the check box next to the channel that will be selected on the remote control station each time SmartPTT Radioserver is started or restarted.

6. To save changes, at the bottom of the SmartPTT Radioserver Configurator window, click **Save Configuration** ().

Postrequisites:

To apply changes immediately, at the bottom of the SmartPTT Radioserver Configurator window, click **Start** () or **Restart** ().

5.8.4.4 Configuring Remote MOTOTRBO Audio Settings

For details, see edit audio settings required to receive voice from the control station and send dispatcher voice to it.

Prerequisites:

From the RG-1000e codeplug, obtain voice encoding and decoding parameters.

Procedure:

1. In SmartPTT Radioserver Configurator, open the **Networks** tab.
2. In the left pane, expand **Remote Gateways** → **<remote gateway name>** → **<control station name>**, and then select **Audio**.

The audio settings appear in the right pane.

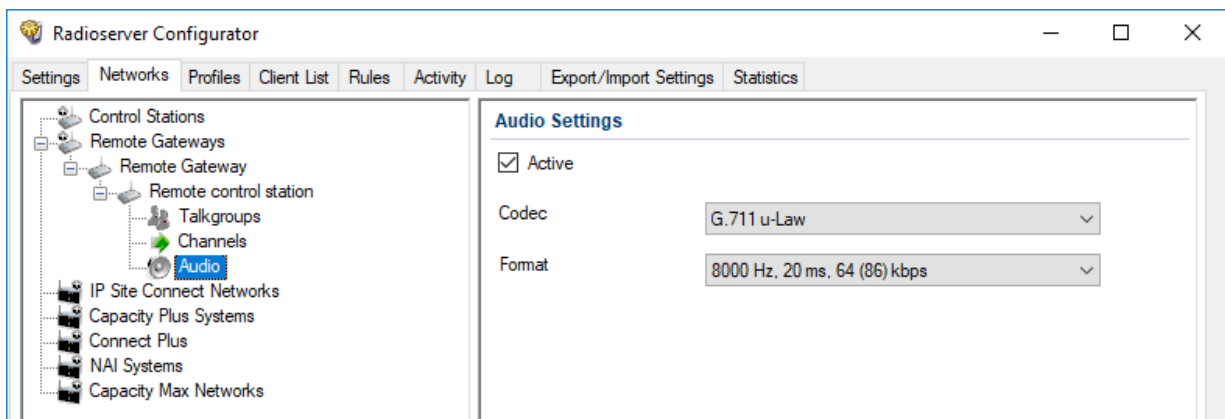

3. In the right pane, select the **Active** check box to unlock audio settings.
4. From the **Codec** list, select the desired codec.
5. From the **Format** list, select the codec parameters.
6. To save changes, at the bottom of the SmartPTT Radioserver Configurator window, click **Save Configuration** ().

Postrequisites:

To apply changes immediately, at the bottom of the SmartPTT Radioserver Configurator window, click **Start** () or **Restart** ().

5.9 Group Duplication

In SmartPTT, talkgroups can be duplicated in control stations, conventional, and trunked radio systems. Duplication significantly simplifies the IP Site Connect configuration.

For duplication, each **Talkgroups** pane of the SmartPTT Radioserver Configurator provides the **Copy** and **Paste** buttons. Copying and pasting is available within SmartPTT Radioserver Configurator only.

SmartPTT does **not** provide tools to import talkgroups from radio codeplugs, repeater codeplugs, configuration files of the MOTOTRBO software, and trunked radio system controllers (Connect Plus and Capacity Max).

5.10 Security Key Duplication

In SmartPTT Radioserver Configurator, security keys can be duplicated in multiple control stations, conventional, and trunked radio systems. Duplication significantly simplifies the IP Site Connect configuration.

For duplication, each **Security Settings** pane of the SmartPTT Radioserver Configurator provides the **Copy** and **Paste** buttons. Copying and pasting is available within SmartPTT Radioserver Configurator only. No security keys can be pasted to a text file that is opened in the operating system.

SmartPTT does **not** provide tools to import security keys from radio codeplugs, repeater codeplugs, configuration files of the MOTOTRBO software, and trunked radio system controllers (Connect Plus and Capacity Max).

6 Other VoIP Systems

In addition to MOTOTRBO, SmartPTT supports the following communication systems with VoIP capabilities:

- Analog radio systems. For details, see [Analog Radio Systems](#).
- Phone systems over SIP trunk. For details, see [SIP Telephony](#).

6.1 SIP Telephony

SmartPTT supports voice communication between any digital radio system and the Customer's phone system that is based on the Session Initiation Protocol (SIP trunk) and supports user agent connections (radioserver and dispatch consoles).

NOTE

In telephony, user agent connections are client connections based on SIP trunk.

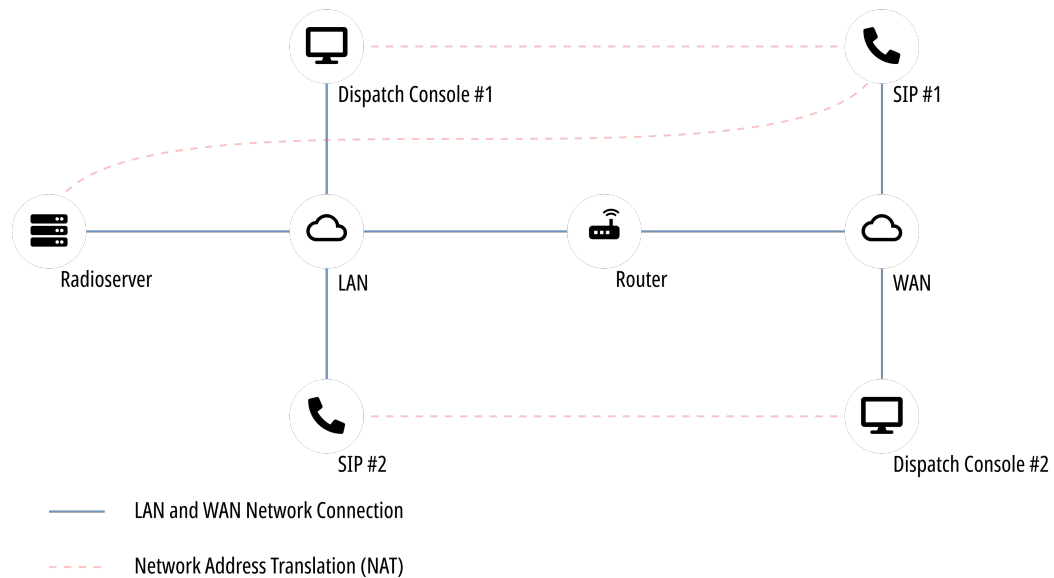

SmartPTT Dispatcher can also have connection to a PBX separately from SmartPTT Radioserver (to the same or another PBX). For details, see "Telephone Interconnect" in *SmartPTT Dispatcher Guide*.

General Requirements for PBX

To support SmartPTT Radioserver connection, PBX must comply with the following requirements:

- User account must belong to the known domain/workgroup in the PBX settings.
- (Optional) SmartPTT Radioserver must have the dedicated user account in PBX.
- All phone devices that are connected to PBX must use the same vocoder.

For detailed information on requirements for PBX, submit a request to the [SmartPTT Technical Support Center](#).

6.1.1 Telephony Features

SmartPTT provides the following features when integrates phone systems and radio systems:

- Various call types:
 - Voice call from a radio network to a phone number (incoming phone call).
 - Voice call from a telephone number to a talkgroup or the All Call ID (outgoing group call).
 - Voice call from a telephone number to a radio (outgoing private call).
- Call initiation request using text messages.
- Calling party authentication. For details, see [Telephony Connection Overview](#).
- Service tones playback (grant tones, hang up tones).
- Software-based volume gain for incoming and outgoing calls.
- Call masks for outgoing calls. For details, see [Call Masks](#).
- Radioserver autoreply. For details, see [Configuring Autoreply](#).

6.1.1.1 Call Process

Phone call between a radio and a telephone number is a complex type of call for the following reasons:

- Radios operate in half-duplex mode (either receive or transmit voice).
- Phones operate in full-duplex mode (receive and transmit at once).

As a result, the call is performed in the following way:

- When the call is established, radio starts receiving audio from the phone.
- When the radio user wants to transmit, they press PTT. At this, the following changes occur:
 - Radio stops hearing phone user and starts transmitting.
 - Phone user starts hearing radio user's voice.
 - Phone user's voice is ignored (not sent to the radio network).
- When the radio user stops transmitting, they release PTT. At this, the following changes occur:
 - Radio starts receiving audio from the phone again.
 - Phone user stops hearing radio user's voice.

If the radio that is involved in the phone call receives a call from another radio, it ends the phone call and starts receiving incoming call from the radio network.

6.1.2 Telephony Connection Overview

SmartPTT connection to PBX for the following phone system and radio system integration, requires the following:

- Planning requirements compliance.
- Additional radio devices configuration.
- Dispatch software configuration.

Important

All of the following information (except SmartPTT configuration) is the minimum required modification. It is **not** sufficient for system integration. For more information and/or configuration assistance, submit a request to [SmartPTT Technical Support Center](#).

Planning Requirements

To implement the system integration, all communication parties must have unique Radio IDs. This includes the following:

- Radios.
- Radioserver (if accesses repeater-based systems).
- Control stations.
- Dispatchers (if authentication is turned on in desktop clients).

If radioserver accesses repeater-based systems, the following system elements must have unique peer IDs (may also be referred to as “repeater radio IDs”):

- Repeaters.
- Radioserver.

Except this, incoming and outgoing masks must be determined for phone calls. For details, see [Call Masks](#).

Additional Radio Devices Configuration

In networks with control stations, radios must be able to interrupt incoming calls.

In repeater-based systems, the following actions must be performed:

- Call start and call end codes must be configured. For details, see [Phone Call Codes](#).
- Phone gateway ID must be configured:
 - For IP Site Connect — gateway ID must be equal to Peer ID of SmartPTT Radioserver.
 - For networks over NAI — gateway ID must be equal to MNIS ID.

In Capacity Max networks, the telephone call functionality must be activated on a trunking controller, and in its settings, the “Standard” signaling type must be selected.

Important

Telephony is unavailable in Connect Plus.

Dispatch Software Configuration

To configure SmartPTT Radioserver, the following actions must be performed:

- SmartPTT license with the Telephone Interconnect permission must be installed. For details, see [Installing License](#).
- Phone call parameters must be configured. For details, see [Configuring Phone Calls](#).
- Radioserver must be connected to PBX. For details, see [Connecting to PBX](#).
- *(Optional)* Radios access to phone system must be limited. For details, see [Limiting Access to PBX](#).
- Incoming phone call processing must be configured. For details, see [Configuring Incoming Calls](#).
- Outgoing phone call processing must be configured. For details, see [Configuring Outgoing Calls](#).
- *(Optional)* Radioserver autoreply must be configured. For details, see [Configuring Autoreply](#).

6.1.2.1 Call Masks

Call masks are used by radioserver for different call types:

- Group phone calls (from a phone to a talkgroup or All Call).
- Private phone calls (from a phone to a radio).

Private Call Mask

To provide private phone calls, no mask is recommended to be used. In this case, phone user must perform the following actions:

1. User dials the radioserver number (as configured in PBX).
2. When radioserver is accessed, user dials the Radio ID of the required radio.

Group Call Masks

Group call masks is the required mask type, especially if the private call mask is not configured. Otherwise, any call from the phone to a radio network will be considered as a private call.

For group phone calls, one of the following masks is recommended to be used:

Mask	Description
0 or 0T	<p>Contains the following expressions:</p> <ul style="list-style-type: none"> • 0 is a number that never appears in the first position of the Radio ID number. • T is an expression for “any number of digits”. <p>Recommended to be used when radioserver connects to a single radio system.</p>
0NT	<p>Contains the following expressions:</p>

Mask	Description
	<ul style="list-style-type: none"> 0 is a number that never appears in the first position of the Radio ID number. N is a network ID. T is an expression for “any number of digits”. <p>Recommended to be used when radioserver connects to multiple radio systems that have the same talkgroup IDs or All Call ID.</p>
OST	<p>Contains the following expressions:</p> <ul style="list-style-type: none"> 0 is a number that never appears in the first position of the Radio ID number. S is the slot ID. T is an expression for “any number of digits”. <p>Recommended to be used when the following conditions are fulfilled:</p> <ul style="list-style-type: none"> Radioserver connects to IP Site Connect with two slots that are not used as data channels. List of talkgroups is equal on those slots.
ONST	<p>Contains all the expressions described above.</p> <p>Recommended to be used when SmartPTT integrated multiple complex systems.</p>
<p>NOTE</p> <p>Radioserver automatically determines number of positions for each ID.</p>	

To initiate a group call using the ONST mask, phone users must perform the following actions:

1. Dial the radioserver number (as configured in PBX).
3. When radioserver is accessed, dial 0.
4. Identify a network:

To specify a network,	dial network ID.
-----------------------	------------------

To avoid the network specification,	dial 0.
-------------------------------------	---------

5. If a call is intended to IP Site Connect, identify a slot:

To determine the first wide slot,	dial 1.
-----------------------------------	---------

To determine the second wide slot,	dial 2.
------------------------------------	---------

To avoid the network specification,	dial 0.
-------------------------------------	---------

6. Enter the required target ID:

To initiate a call to a talkgroup,	dial talkgroup ID.
------------------------------------	--------------------

To initiate an All Call,

dial 0.

NOTE

Do not use a standard All Call ID.

Masks Syntax

Call masks may include one or several of the following expressions:

Expression	Description
.	Any single digit in the specific position.
[a-f]	A single Latin letter from the specified range may occur in this particular position. Important Lowecase letters must be used.
[a,b,c]	One of the specified Latin letters may occur in a position. Important Lowecase letters must be used.
[abc]	Same as [a , b , c]
T	Starting the current position, any amount of digits can be entered that will be interpreted as a single parameter.
(.)	OR operator for multiple masks.
{ }	Content of such brackets must be included in the parameter.
N	Specific network ID or the 0 value that is equivalent to "ANY". Applicable to group phone calls only.
S	Specific slot ID or the 0 value that is equivalent to "ANY". Applicable to group phone calls only.

6.1.2.2 Phone Call Codes

To initiate and end phone calls, specific codes must be configured in radio codeplugs. They are configured in the Dual-Tone Multi-Frequency (DTMF) format. The format determines the following set of characters to be used:

- All arabic digits (from 0 to 9).
- Latin letters "A", "B", "C", and "D".
- The asterisk character (*).

- The number/hash/pound character (#).

Codes are recommended to comply with the following requirements:

- Each code must consists of at least two characters.
- Each code must include either asterisk, or hash.

EXAMPLE

Call initiation code: *1

Call end code: #1

6.1.3 Configuring Phone Calls

Follow the procedure to configure phone call processing in SmartPTT.

Prerequisites:

- Ensure that SmartPTT license allows telephone interconnect. For details, see [Viewing License Items](#).
- Obtain access and deaccess codes configured in radios.

Procedure:

1. In SmartPTT Radioserver Configurator, open the **Settings** tab.
2. In the left pane, expand **Add-on Modules**, and then click **Phone Calls**.
The phone call settings appear in the right pane.

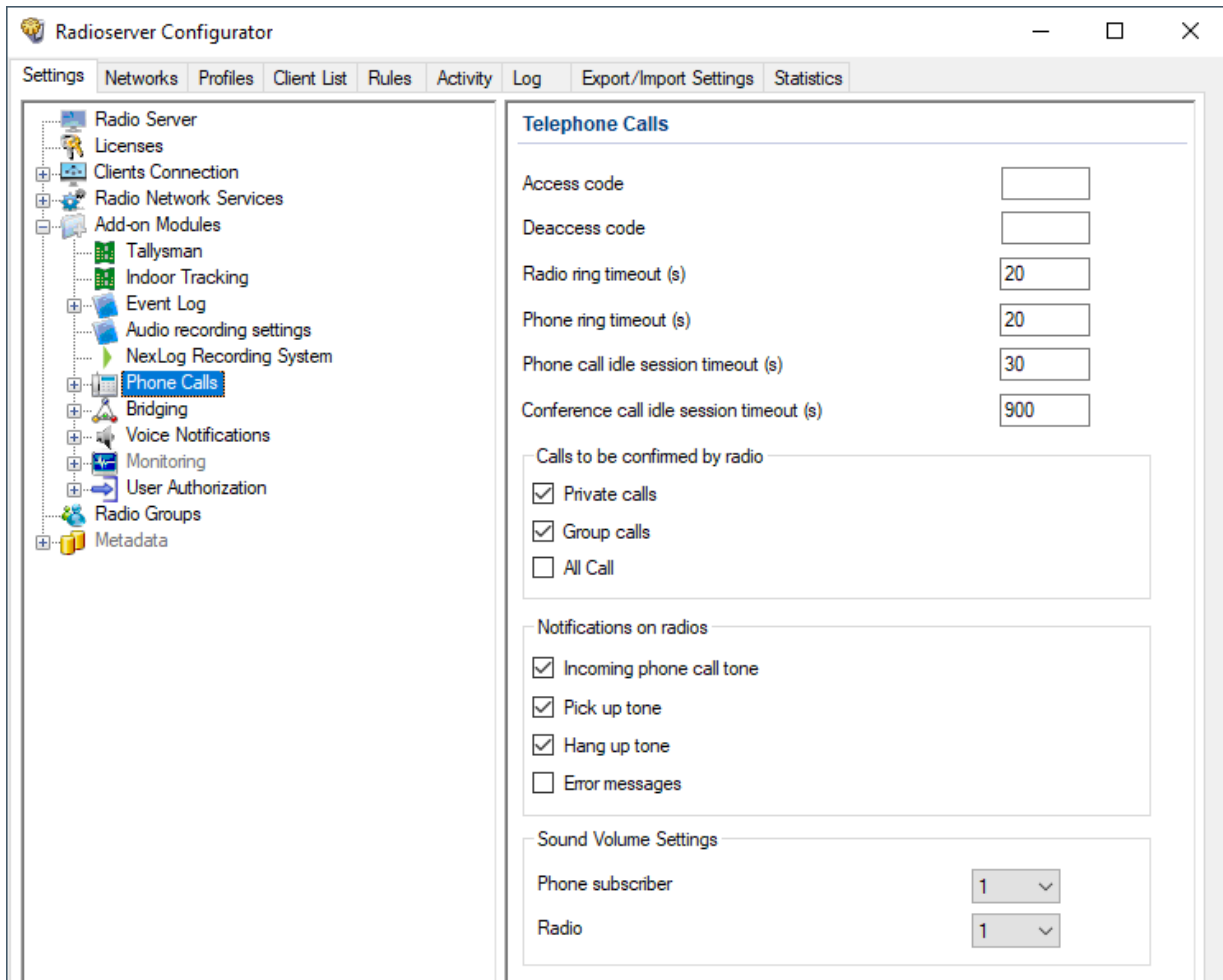

3. In the right pane, in the **Access code** field, type the code that means the phone call initiation from the radio.
4. In the **Deaccess code** field, type the code that means phone call end by a radio.
5. In the **Radio ring timeout (s)** field, type the maximum wait time for a radio to accept a call from a phone subscriber.
6. In the **Phone ring timeout (s)** field, type the maximum wait time for a phone subscriber to accept a call from a radio.
7. In the **Phone call idle session timeout (s)** field, type the maximum wait time for a radio to transmit during a phone call.
8. In the **Conference call idle session timeout (s)** field, type the maximum wait time for a radio to transmit during a conference call.
9. In the **Calls to be confirmed by radio** area, perform the following actions:

To require confirmation of private calls by radios, select the **Private calls** check box.

To require confirmation of group calls by radios, select the **Group calls** check box.



To require confirmation of all calls by radios, select the **All Calls** check box.

10. Configure notification of radios about phone call status:

To notify radios about waiting for the phone subscriber to pick up,	select the Incoming phone call tone check box.
To notify radios that the phone subscriber has accepted the call (picked up),	select the Pick up tone check box.
To notify radios that the phone subscriber has ended the call (hung up),	select the Hang up check box.
To notify radios that SmartPTT Radioserver has failed to initiate the call,	select the Error messages check box.

11. *(Optional)* Configure software-based volume gain for call participants:
 - a. From the **Phone subscriber** list, select the desired amplification factor for phone subscriber voice transmissions.
 - b. From the **Radio** list, select the desired amplification factor for radio user voice transmissions.
12. To save changes, at the bottom of the SmartPTT Radioserver Configurator window, click **Save Configuration** ().

Postrequisites:

To apply changes immediately, at the bottom of the SmartPTT Radioserver Configurator window, click **Start** () or **Restart** ().

6.1.4 Connecting to PBX

Follow the procedure to configure the connection between SmartPTT Radioserver and PBX.

Prerequisites:

- Ensure that SmartPTT license allows Telephone Interconnect. For details, see [Viewing License Items](#).
- Obtain the IP address, network ports and communication protocols used to connect SmartPTT Radioserver to PBX.
- Obtain the list of voice codecs supported by PBX, telephones and telephone gateways.

Procedure:

1. In SmartPTT Radioserver Configurator, open the **Settings** tab.
2. In the left pane, expand **Add-on Modules** → **Phone Calls**, and then click **Telephone Interconnect**. The PBX connection settings appear in the right pane.

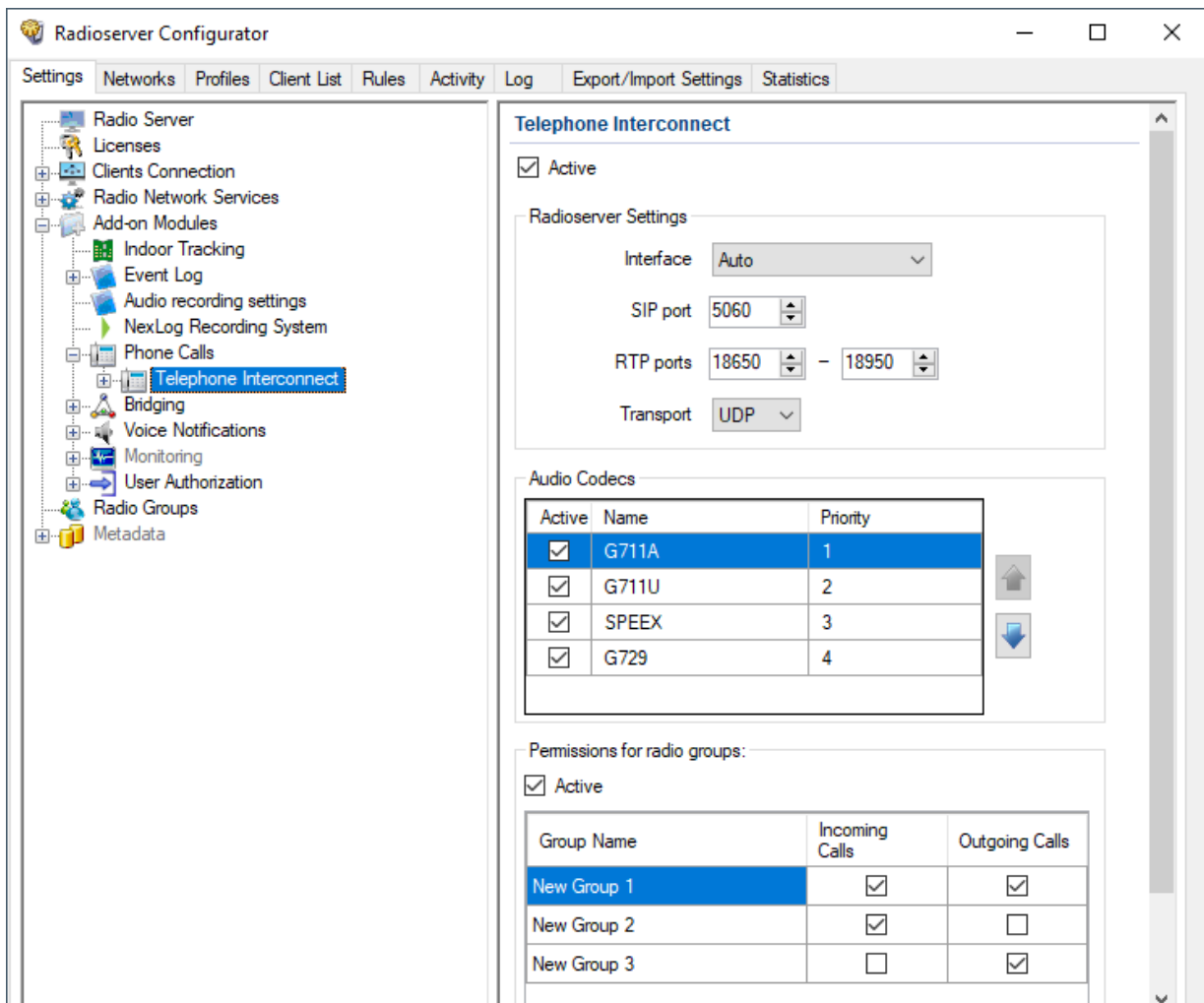

3. In the right pane, select the **Active** check box.
4. In the **Radioserver Settings** area, perform the following actions:
 - a. From the **Interface** list, select the desired option:

 To use any radioserver IP address, select *Auto*.

 To use fixed radioserver IP address, select the specific IP address.

 - b. In the **SIP port** field, enter the radioserver port number to be used for PBX connection.
 - c. In the **RTP ports** fields, enter the lower and upper boundary of the UDP port range to be used for voice traffic between SmartPTT Radioserver and PBX.

Important

Number of ports in the range must be equal to the maximum number of simultaneous phone calls over a radioserver.

- d. From the **Transport** list, select the desired transport protocol:

If TCP is configured in PBX, select *TCP*.

If UDP is configured in PBX, select *UDP*.

5. In the **Audio Codecs** area, perform the following actions:

- a. In the table, in the **Active** column, select the check boxes of codecs supported by PBX and telephone gateways (if available).
- b. Configure codec priority:

To increase vocoder use priority,

perform the following actions:

1. Click the desired codec in the table.
2. Click **Increase priority** () to move the codec up in the table.



To decrease vocoder use priority,

perform the following actions:

1. Click the desired codec in the table.
 2. Click **Decrease priority** () to move the codec down in the table.
-

6. To save changes, at the bottom of the SmartPTT Radioserver Configurator window, click **Save Configuration** ().

Postrequisites:

- (Optional) Limit access to the telephone network for radios. For details, see [Limiting Access to PBX](#).
- To apply changes immediately, at the bottom of the SmartPTT Radioserver Configurator window, click **Start** () or **Restart** ().

6.1.4.1 Limiting Access to PBX

Follow the procedure to limit radios access to the phone system.

Prerequisites:

- Configure radioserver connection to PBX. For details, see [Connecting to PBX](#).
- Create and configure desired groups of radios. For details, see [Managing Radio Groups](#).

Procedure:

1. In SmartPTT Radioserver Configurator, open the **Settings** tab.
2. In the left pane, expand **Add-on Modules** → **Phone Calls**, and then click **Telephone Interconnect**. The PBX connection settings appear in the right pane.

The screenshot shows the Radioserver Configurator window. The left pane displays a tree view with 'Telephone Interconnect' selected. The right pane shows the configuration for 'Telephone Interconnect', including 'Active' checkbox, 'RadioServer Settings' (Interface: Auto, SIP port: 5060, RTP ports: 18650-18950, Transport: UDP), 'Audio Codescs' table, and 'Permissions for radio groups' table.

Active	Name	Priority
<input checked="" type="checkbox"/>	G711A	1
<input checked="" type="checkbox"/>	G711U	2
<input checked="" type="checkbox"/>	SPEEX	3
<input checked="" type="checkbox"/>	G729	4

Group Name	Incoming Calls	Outgoing Calls
New Group 1	<input checked="" type="checkbox"/>	<input checked="" type="checkbox"/>
New Group 2	<input checked="" type="checkbox"/>	<input type="checkbox"/>
New Group 3	<input type="checkbox"/>	<input checked="" type="checkbox"/>

- In the right pane, in the **Permissions for radio groups** area, select the **Active** check box.
- For each radio group in the table, perform the following actions:



To allow private phone calls to radios, in the **Incoming Calls** column, select the check box.

To allow group phone calls confirmation to radios, in the **Incoming Calls** column, select the check box.

To allow radios in the group to initiate calls to phone subscribers, in the **Outgoing Calls** column, select the check box.

- To save changes, at the bottom of the SmartPTT Radioserver Configurator window, click **Save Configuration** ().

Postrequisites:

To apply changes immediately, at the bottom of the SmartPTT Radioserver Configurator window, click **Start** () or **Restart** ().

6.1.5 Configuring Incoming Calls

Follow the procedure to configure handling of phone calls from telephone network to the radio network.

Prerequisites:

- Configure PBX connection. For details, see [Connecting to PBX](#).
- From PBX configuration, obtain the credentials (username, password and realm) to be used for authentication.

Procedure:

1. In SmartPTT Radioserver Configurator, open the **Settings** tab.
2. In the left pane, expand **Add-on Modules** → **Phone Calls** → **Telephone Interconnect**, and then click **Incoming Calls**.

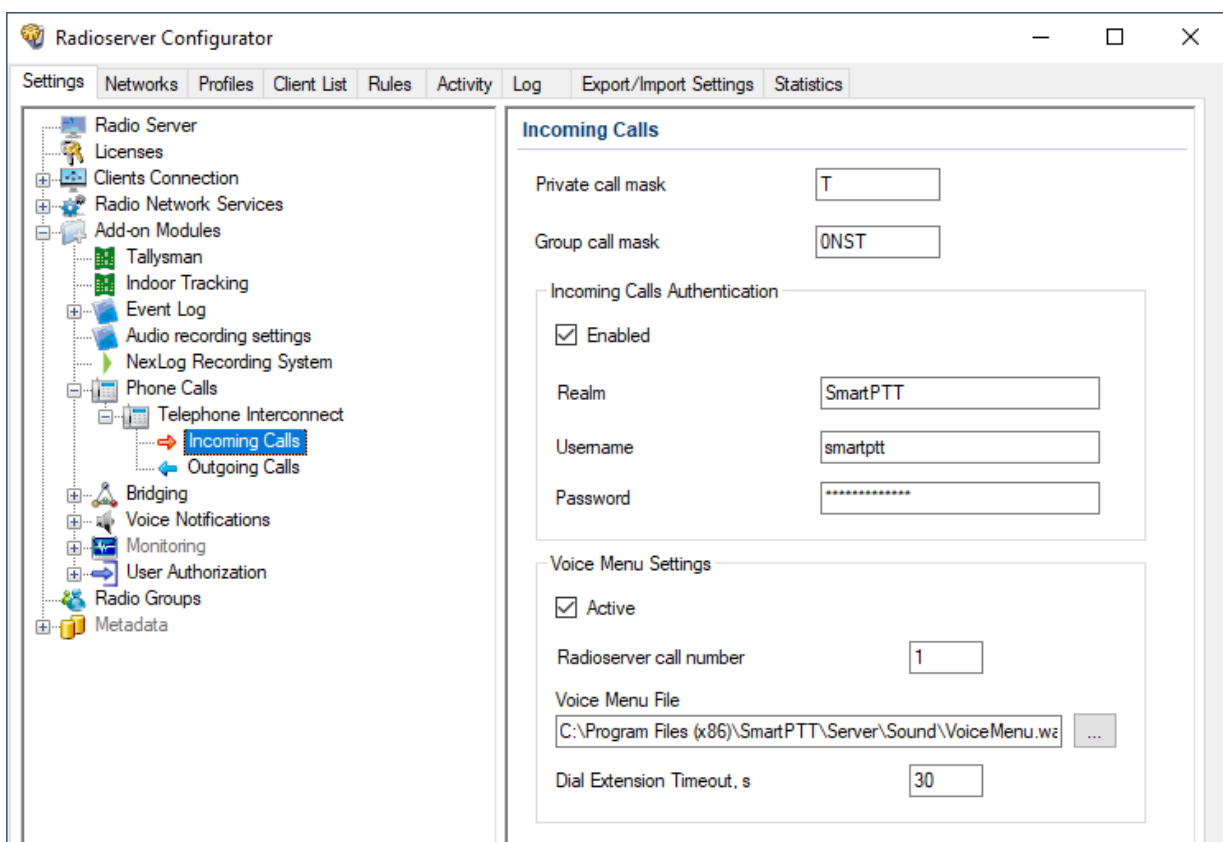

Incoming phone calls settings appear in the right pane.



3. (Optional) In the right pane, in the **Private call mask** field, type the desired mask.
4. In the **Group call mask** field, type the desired mask (the recommended mask is *0NST*).
5. In the **Incoming Calls Authentication** area, configure phone subscriber authentication:
 - a. Select the **Enabled** check box.
 - b. In the **Realm** field, type the name of the realm the phone user must belong to.
 - c. In the **Username** field, type the name of the account to be used for authentication.
 - d. In the **Password** field, type the corresponding password.

6. To save changes, at the bottom of the SmartPTT Radioserver Configurator window, click **Save Configuration** ().

Postrequisites:

- Configure SmartPTT Radioserver voice menu for incoming calls from the telephone network. For details, see [Configuring Autoreply](#).
- Configure outgoing calls (from radio network to the telephone network). For details, see [Configuring Outgoing Calls](#).
- To apply changes immediately, at the bottom of the SmartPTT Radioserver Configurator window, click **Start** () or **Restart** ().

6.1.6 Configuring Autoreply

Follow the procedure to configure the radioserver autoreply to phone users when they initiate a phone call.

Prerequisites:

- In PBX, configure the radioserver dial number.
- Create an audio file to be used as an autoreply.
- Determine the maximum wait time for a telephone subscriber to dial the number for calls to the radio network.

Procedure:

1. In SmartPTT Radioserver Configurator, open the **Settings** tab.
2. In the left pane, expand **Add-on Modules** → **Phone Calls** → **Telephone Interconnect**, and then click **Incoming Calls**.
The incoming calls settings appear in the right pane.

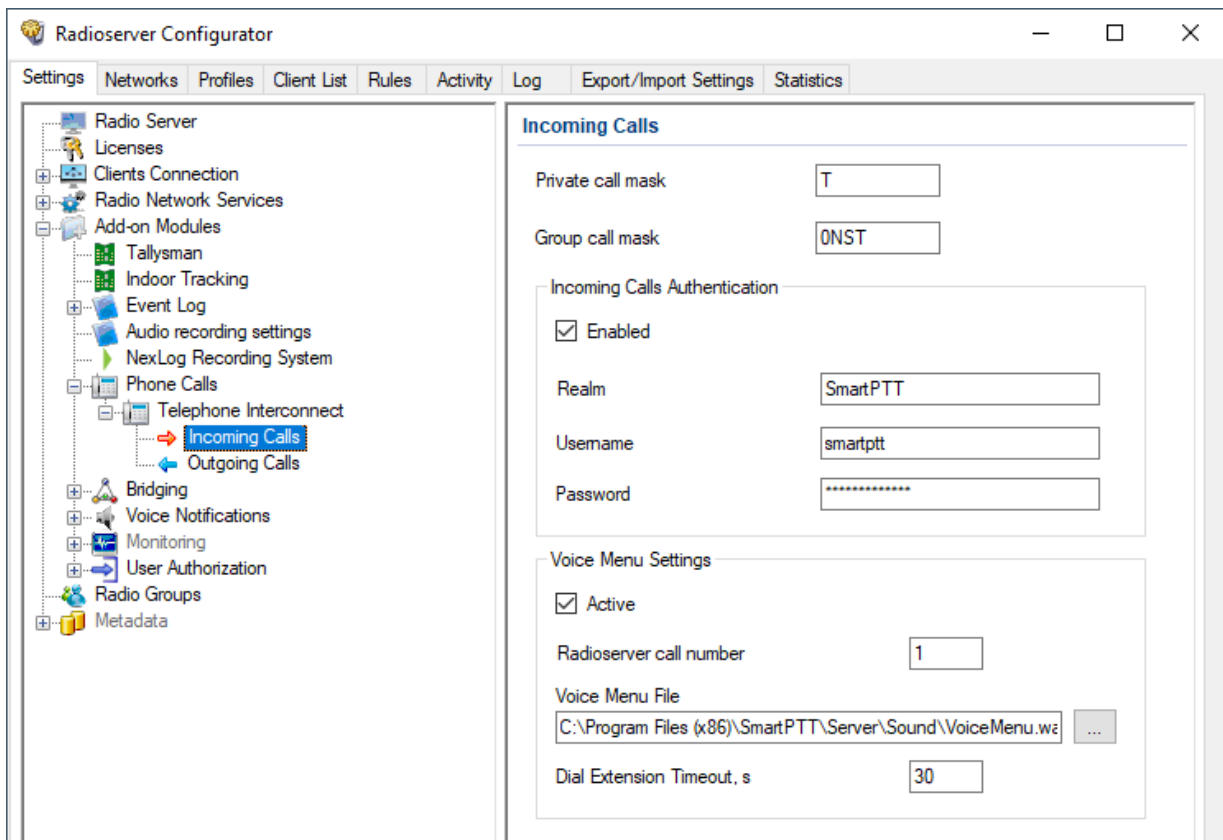



3. In the right pane, in the **Voice Menu Settings** area, select the **Active** check box.
4. In the **Radioserver call number** field, type the radioserver dial number.
5. Configure the audio file:
 - a. Next to the **Voice Menu File** heading, click the Browse () button. The dialog box appears.
 - b. In the dialog box, select the desired file.
6. In the **Dial Extension Timeout, s** field, type the maximum wait time for the phone user to dial the number that initiates a call to the radio network.

Important

The parameter must be greater than the audio file length.

7. To save changes, at the bottom of the SmartPTT Radioserver Configurator window, click **Save Configuration** ().

Postrequisites:

To apply changes immediately, at the bottom of the SmartPTT Radioserver Configurator window, click **Start** () or **Restart** ().

6.1.7 Configuring Outgoing Calls

Follow the procedure to configure the handling of calls from radio network to telephone network.

Prerequisites:

- Configure PBX connection. For details, see [Connecting to PBX](#).
- Obtain the PBX connection settings (IP address and port number).
- From the PBX settings, obtain the credentials (realm, username and password) required for SmartPTT Radioserver authentication.
- From the PBX settings, obtain the codes used to access the desired telephone network as well as prefixes and/or postfixes for callbacks.

Procedure:

1. In SmartPTT Radioserver Configurator, open the **Settings** tab.
2. In the left pane, expand **Add-on Modules** → **Phone Calls** → **Telephone Interconnect**, and then click **Outgoing Calls**.

The outgoing call settings appear in the right pane.

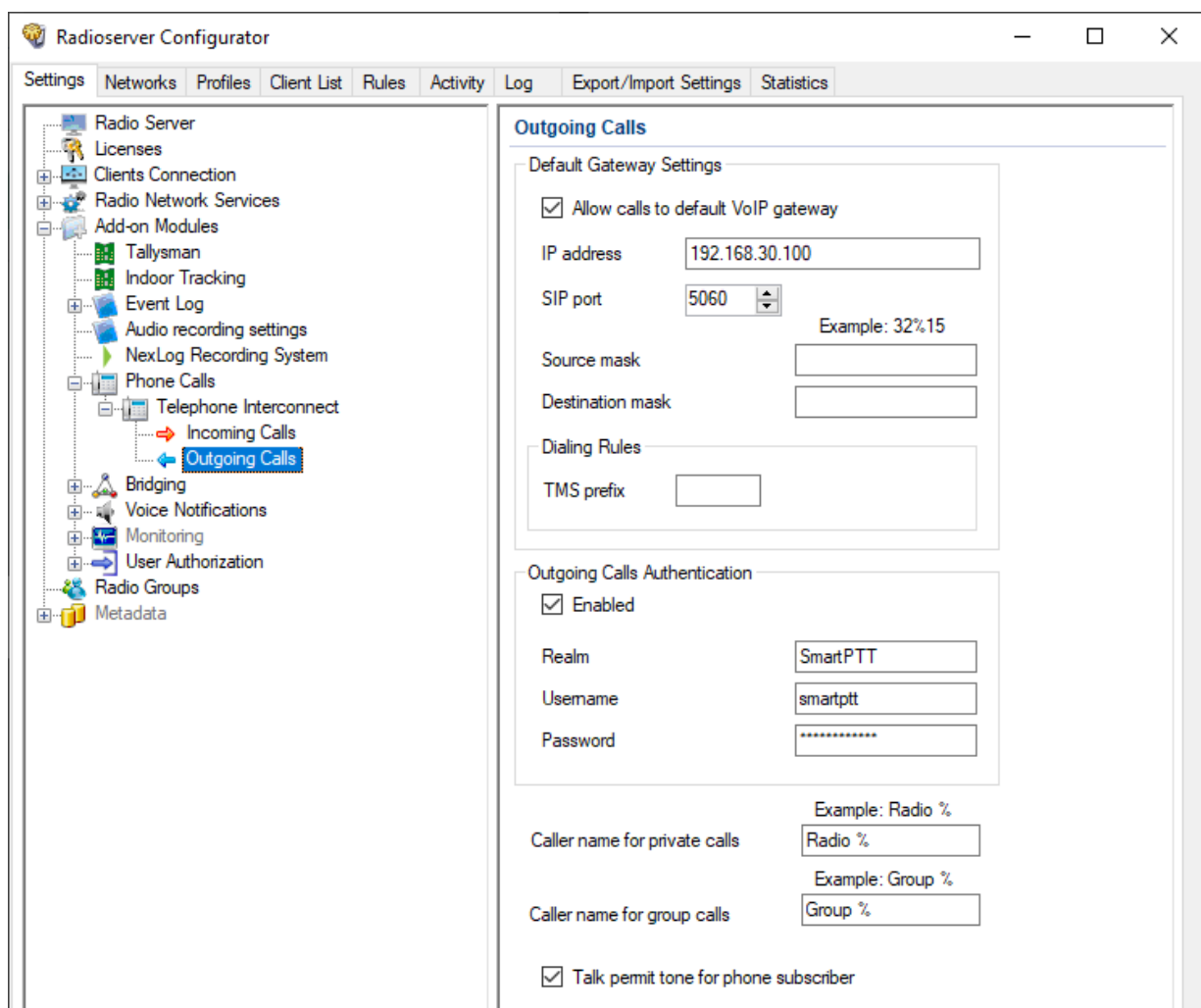

3. In the right pane, configure radioserver connection to PBX:
 - a. Select the **Allow calls to default VoIP gateway** check box.
 - b. In the **IP address** field, type PBX IP address in dot-decimal notation.
 - c. In the **SIP port** field, type the PBX port number to which SmartPTT Radioserver will connect.
 - d. In the **Source mask** field, type the expression to be dialed by phone subscribers to call back radios. Use the "%" character to be substituted by the caller radio ID.
 - e. In the **Destination mask** field, type the expression to be entered by radios to call back phone subscribers. Use the "%" character to be substituted by the caller phone number.
4. *(Optional)* To configure outgoing call initiation by sending a text message to radioserver ID, in the **Dialing Rules** area, type the TMS text.
5. In the **Outgoing Calls Authentication** area, configure SmartPTT Radioserver authentication:

If PBX requires authentication,

perform the following actions:



1. Select the **Enabled** check box.
2. In the **Realm** field, type the name of the realm that SmartPTT Radioserver account belongs to.
3. In the **Username** field, type the name of SmartPTT Radioserver account in PBX.
4. In the **Password** field, type the password of SmartPTT Radioserver account in PBX.

If PBX does **not** require authentication,

clear the **Enabled** check box.

6. *(Optional)* Configure the caller name format (appears on the phone display):
 - a. In the **Caller name for private calls** field, type the caller name format for private calls.
 - b. In the **Caller name for group calls** field, type the caller name format for group calls.
7. Select the **Talk permit tone for phone subscriber** check box to play a call permit tone/grant tone that informs phone users that they can speak.
8. To save changes, at the bottom of the SmartPTT Radioserver Configurator window, click **Save Configuration** ().

Postrequisites:

To apply changes immediately, at the bottom of the SmartPTT Radioserver Configurator window, click **Start** () or **Restart** (.

6.2 Analog Interfaces

In SmartPTT, the “analog interface” term refers to the control station connection interface that provides only voice reception and initiation. The interface is completely provided by the RG-1000e radio gateway only.

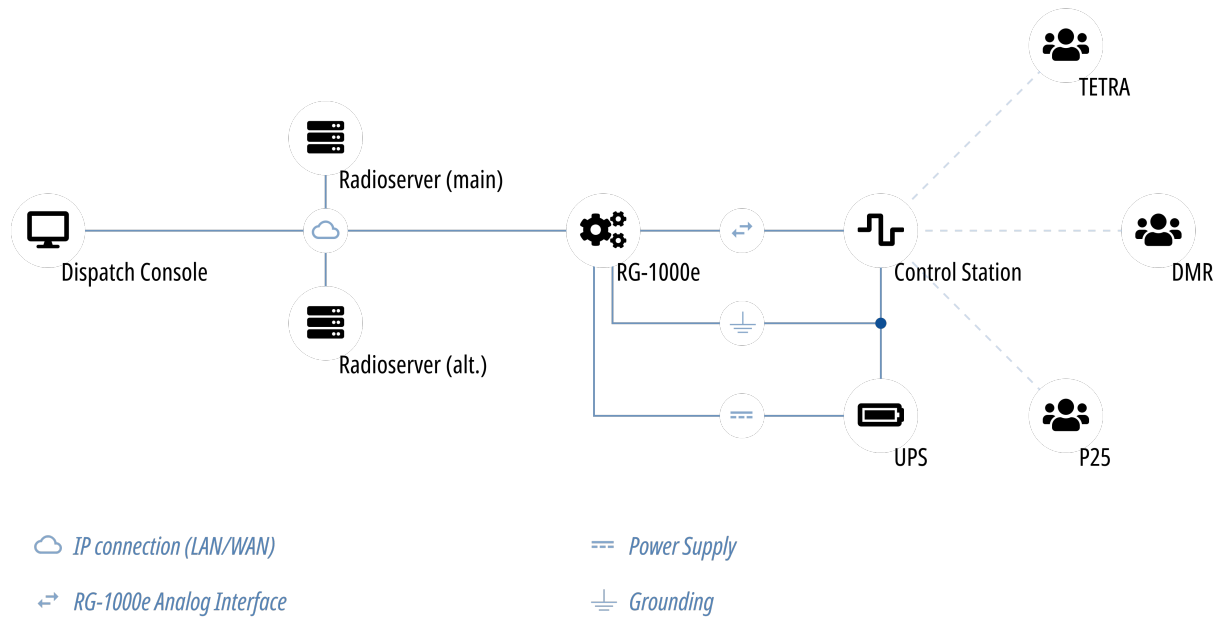

Interface provides the following features:

- Control station channel selection.
- Voice reception on the channel (incoming transmission).
- Voice transmission on the channel (outgoing transmission).

The interface does **not** support PTT ID (call target), Call ID (initiator), radio commands, and the wireline control station operation. For details, submit a request to the [SmartPTT Technical Support Center](#).

Analog interface may be referred to as “E&M”. The reference is incorrect. E&M implies specific connection types and voltage levels on the interface pins.

Information on radio models and the corresponding radio systems is available in the RG-1000e documentation. For additional information, contact Elcomplus LLC representative in your region.

Using mobile/base radios as control stations implies that they are **not** operated directly. This includes the following:

- No person must switch channels on the control station using Control Head buttons or other controls.
- No person must transmit from the radio using Control Head buttons or handsets.

Violation of such requirements results in the data desynchronization between SmartPTT and a control station.

6.2.1 Analog Interface Configuration

Analog interface configuration requires the following:

- Control station configuration. For details, see “Control Station Configuration” [below](#).
- Additional digital radios configuration. For details, see “Radio Gateway Configuration” [below](#).
- SmartPTT configuration. For details, see “SmartPTT Configuration” [below](#).

Important

Information below provides the minimum required changes in radio equipment settings. It is **not** sufficient for operation. For configuration assistance, submit a request to [SmartPTT Technical Support Center](#).

Control Station Configuration

To connect a base/mobile radio to SmartPTT over the analog interface and use in as a control station, the following changed must be performed:

- Control station GPIO pins must be configured for the following purposes:
 - Audio output.
 - Audio input.
 - PTT signal reception.
 - Incoming call detection (VOX, CSQ, or other).
- If channel selection is required, the following actions must be performed:
 - Up to 4 additional pins must be configured for channel selection.
 - All control station channels must be configured in the zone with ID = 1 (if multiple zones are supported).

Radio Gateway Configuration

To configure RG-1000e for analog interface support, the following actions must be performed:

- Control station must be connected to the gateway using the dedicated cable. For details, see RG-1000e Remote Gateway User Guide.
- Power supply and grounding must be configured correctly for control station gateway.

WARNING

Power connection may result in the unintended personnel injury or equipment damage. The connection must be performed with a qualified engineer who have the corresponding license.

- In gateway configuration file, the correct connection mode must be configured:
 - IO connection mode.
 - Control station connection.
- Gateway IP channel must be associated with the corresponding radio port.

- Radio port pinout must be configured in accordance with the control station model and voice detection mode in the control station.
- *(Optional)* Audio gain/attenuation must be configured for the radio port.

For information on the gateway settings, see the corresponding documentation:

- *RG-1000e Remote Gateway User Guide*
- *CPS RG-1000e User Guide*

SmartPTT Configuration

To configure the control station connection over the analog interface, the following actions must be performed:

- SmartPTT license with RG-1000e permission must be installed. For details, see [Installing License](#).
- Connection to the control station must be configured. For details, see [Configuring Station Connection over Analog Interface](#).
- Control station channels must be configured. For details, see [Configuring Channels for Analog Interface](#).
- Voice processing must be configured. For details, see [Configuring Analog Interface Audio](#).

6.2.2 Configuring Station Connection over Analog Interface

Follow the procedure to configure the control station connection over the analog interface.

Prerequisites:

- From the radio gateway configuration file, receive the IP address and port number configured for the desired control station.
- From the control station codeplug, receive the the control station serial number.
- Determine the connection mode to the control station.
- *(Optional)* Determine SmartPTT Radioserver host ports that will be used to receive different data types from the control station.

Procedure:

1. In SmartPTT Radioserver Configurator, open the **Networks** tab.
2. Select the control station:

To add control station to a new gateway,

perform the following actions:

1. Right-click **Remote Gateways**, and then click **Add**.
2. In the right pane, select the **Active** check box.
3. *(Optional)* In the **Name** field, type the gateway name.
4. In the left pane, right-click the **<Gateway Name>** node, point to **Add**, and then select **Remote I/O Control Station**.

To add a control station to an existing gateway,

perform the following actions:

1. Expand the **Remote Gateways** node.
2. Right-click the desired gateway name, point to **Add**, and then select **Remote I/O Control Station**.

To edit an existing control station connection settings,

expand **Remote Gateways** → **<Gateway Name>**, and then click the desired control station.

To delete a control station connection,

perform the following actions:

1. Expand **Remote Gateways** → **<Gateway Name>**.
2. Right-click the desired control station, and then select **Delete**.
3. Proceed to the last step of the procedure.

The control station settings appear in the right pane.

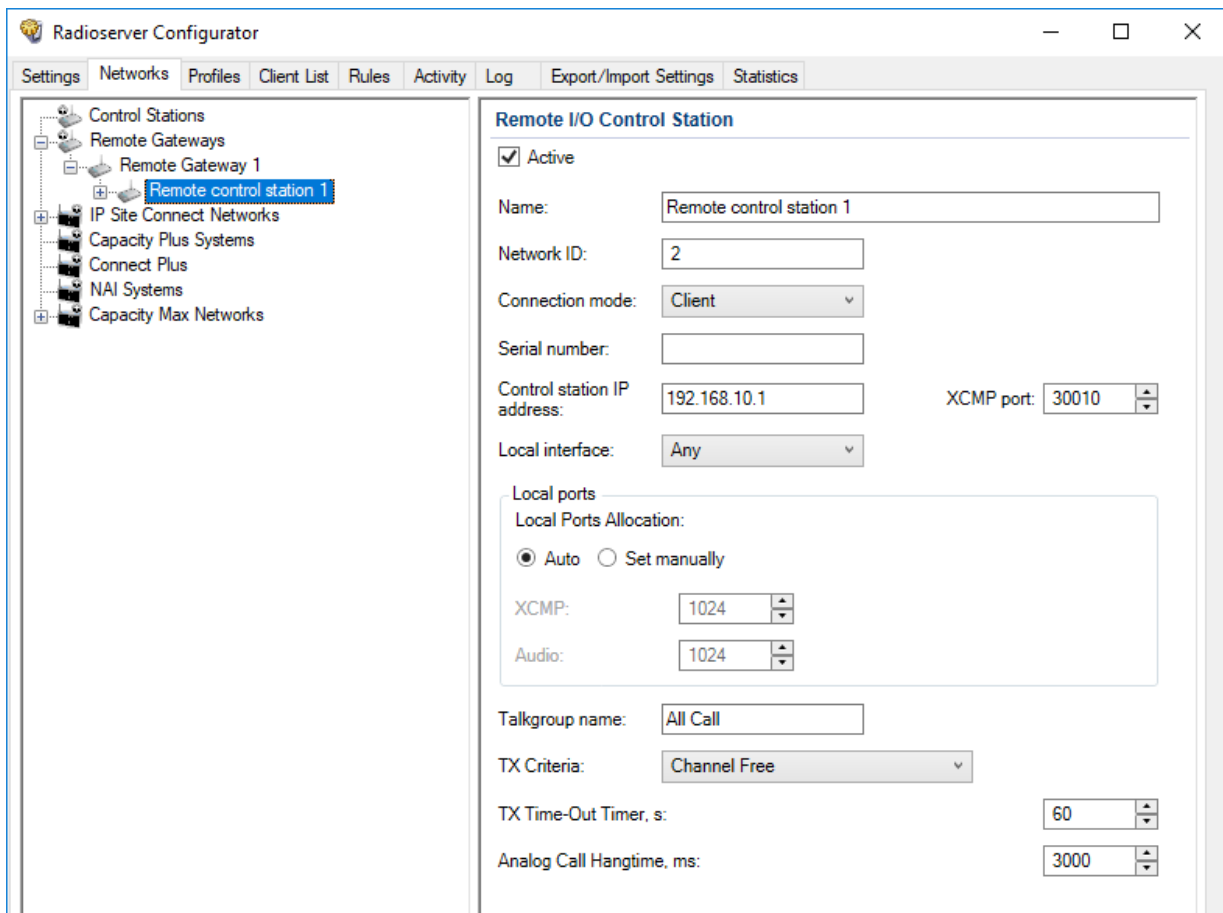

3. In the right pane, select the **Active** check box to unlock control station settings.
4. In the **Name** field, type the control station name.
5. Leave the value in the **Network ID** field unchanged.
6. From the **Connection mode** list, select the connection mode to the control station:

If RG-1000e is configured to accept SmartPTT connection,

perform the following actions:

1. From the **Connection mode** list, select *Client*.
2. In the **Control station IP address** field, type the IP address configured in the gateway for the control station.
3. In the **XCMP port** field, enter the port number that is configured in the gateway for commands and service messages exchange between a radioserver and the gateway.

If RG-1000e is configured to initiate SmartPTT connection,

perform the following actions:

1. From the **Connection mode** list, select *Server*.

2. In the **XCMP local port** field, enter the port number allocated in a radioserver for the control station connection.

7. From the **Local Interface** list, select the proper option:

To allow using any radioserver IP address for connection, select *Any*.

To allow using the fixed IP address, select the desired IP address.

8. *(Optional)* Set SmartPTT Radioserver host ports for different types of data:

If you want local ports to be set automatically, select *Auto*.

If you want to set specific local port values, perform the following actions:

1. Select *Set manually*.
2. If appears, in the **XCMP** field, enter the port number used for commands and service messages exchange between a radioserver and the gateway.
3. In the **Audio** field, enter the number of the port used to receive and transmit voice.

9. *(Optional)* Configure the following miscellaneous options:

- a. In the **Serial number** field, type the control station serial number.
- b. In the **Talkgroup name** field, type the talkgroup name.

10. From the **TX Criteria** list, select one of the following options:

If the control station is configured to transmit only when no other transmissions are detected over the radio channel, select *Channel Free*.

If the control station is configured to completely ignore other transmission over the radio channel, select *Always*.

Important

SmartPTT does **not** support color code criteria for outgoing transmissions.

11. In the **TX Time-Out Timer**, s field, enter the maximum duration of voice transmission on the channel.
12. In the **Analog Call Hangtime**, ms field, enter the maximum time interval between transmissions over analog channels that will be considered as transmissions within the same call in SmartPTT.

Postrequisites:

- Configure control station channels. For details, see Channels.
- Configure audio settings. For details, see Audio.
- To apply changes immediately, at the bottom of the SmartPTT Radioserver Configurator window, click **Start** (▶) or **Restart** (▶▶).

6.2.3 Configuring Channels for Analog Interface

Follow the procedure to add new or edit existing channels of remote control stations.

Prerequisites:

- Configure channel selection in the control station using GPIO pins.
- In the control station, configure channels under the first zone.
- Determine the default control station channel.
- Configure a control station connection. For details, see [Configuring Station Connection over Analog Interface](#).

Procedure:

1. In SmartPTT Radioserver Configurator, open the **Networks** tab.
2. In the left pane, expand **Remote Gateways** → **<Gateway Name>** → **<Station Name>**, and then select **Channels**.

The list of channels appears in the right pane.

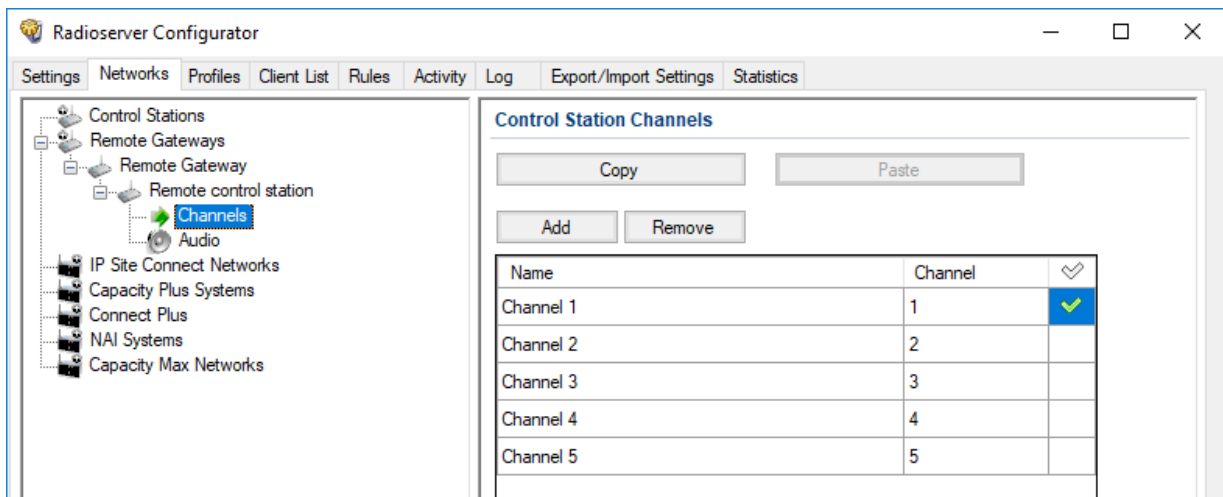

3. In the right pane, perform the following actions:

To add a new channel,

click **Add**.

To edit an existing entry,



proceed to the next step of the procedure.

To remove an existing channel,



perform the following actions:

1. Click the desired entry.

2. Click the **Remove** button.

4. In the table, in the desired entry, perform the following actions:
 - a. In the **Name** column, double-click the current channel name, and then type a new name.
 - b. In the **Channel** column, double-click the current channel ID, and then type the desired channel ID.
5. When all channels are added, in the **Default Channel** () column, click the desired entry to configure the default channel. It will be selected each time the control station is started or restarted.
6. To save changes, at the bottom of the SmartPTT Radioserver Configurator window, click **Save Configuration** ().

Postrequisites:

To apply changes immediately, at the bottom of the SmartPTT Radioserver Configurator window, click **Start** () or **Restart** ().

6.2.4 Configuring Audio Processing over Analog Interface

Follow the procedure to edit audio processing settings required to receive voice from the control station and send dispatcher voice to it.

Prerequisites:

- From the RG-1000e codeplug, obtain voice encoding and decoding parameters.
- Configure a control station connection. For details, see [Configuring Station Connection over Analog Interface](#).

Procedure:

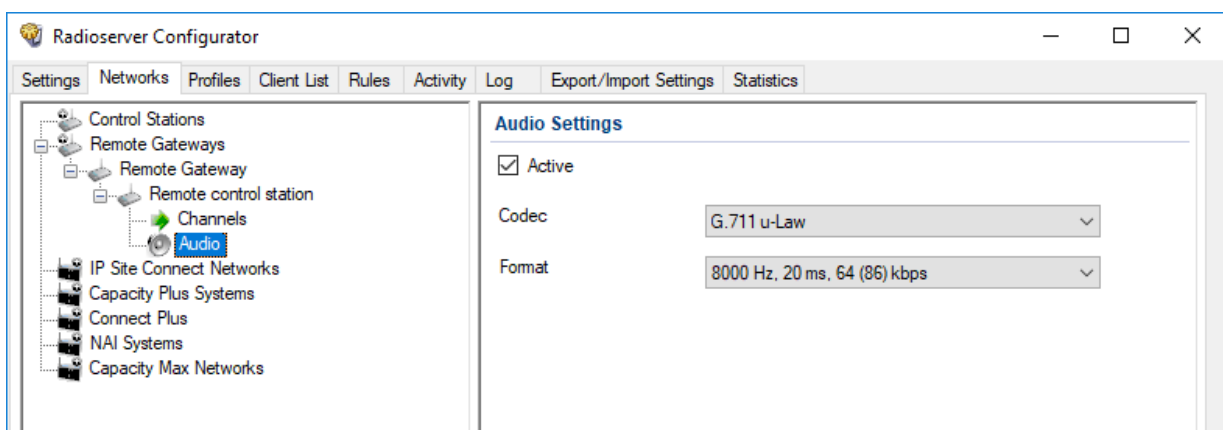

1. In SmartPTT Radioserver Configurator, open the **Networks** tab.
2. In the left pane, expand **Remote Gateways** → **<Gateway Name>** → **<Station Name>**, and then select **Audio**. The audio settings appear in the right pane.



3. In the right pane, select the **Active** check box to unlock audio settings.
4. From the **Codec** list, select the desired vocoder and its algorithm.
5. From the **Format** list, select the desired vocoder parameters.

6. To save changes, at the bottom of the SmartPTT Radioserver Configurator window, click **Save Configuration** ().

Postrequisites:

To apply changes immediately, at the bottom of the SmartPTT Radioserver Configurator window, click **Start** () or **Restart** ().

6.3 Analog Radio Systems

Analog systems are those that use frequency modulation and (optionally) various in-band audible signaling systems. For example, the following analog signaling can be used:

- MDC-1200.
- Five-tone signaling (for example, Select 5).

SmartPTT provides the limited support of analog radio systems and limited integration capabilities. Access to those systems is provided in one of the following ways:

MOTOTRBO Control Stations

MOTOTRBO control stations provide the partial voice and signaling transcoding and information provision to SmartPTT. For information on MOTOTRBO stations usage, see [MOTOTRBO Control Stations](#).

Analog Interface

Analog interface provides the ability to receive voice transmissions, initiate voice transmissions, and switch station channels. The interface is provided by the RG-1000e radio gateway. For information on analog interfaces in SmartPTT, see [Analog Interfaces](#).

7 Data Exchange Systems

In addition to various VoIP communication systems, SmartPTT supports various data transferring systems. Those systems are as follows:

- Email Services. For details, see [Email Services](#).
- Mobile Network Services. For details, see [Mobile Phone Networks](#).
- SmartPTT File Transfer. For details, see [SmartPTT File Transfer](#).
- Avigilon. For details, see [Avigilon](#).

7.1 Email Services

SmartPTT supports email services connection to provide text messages delivery to email addresses for radios and dispatchers. It also provides the ability to send text messages from mailboxes.

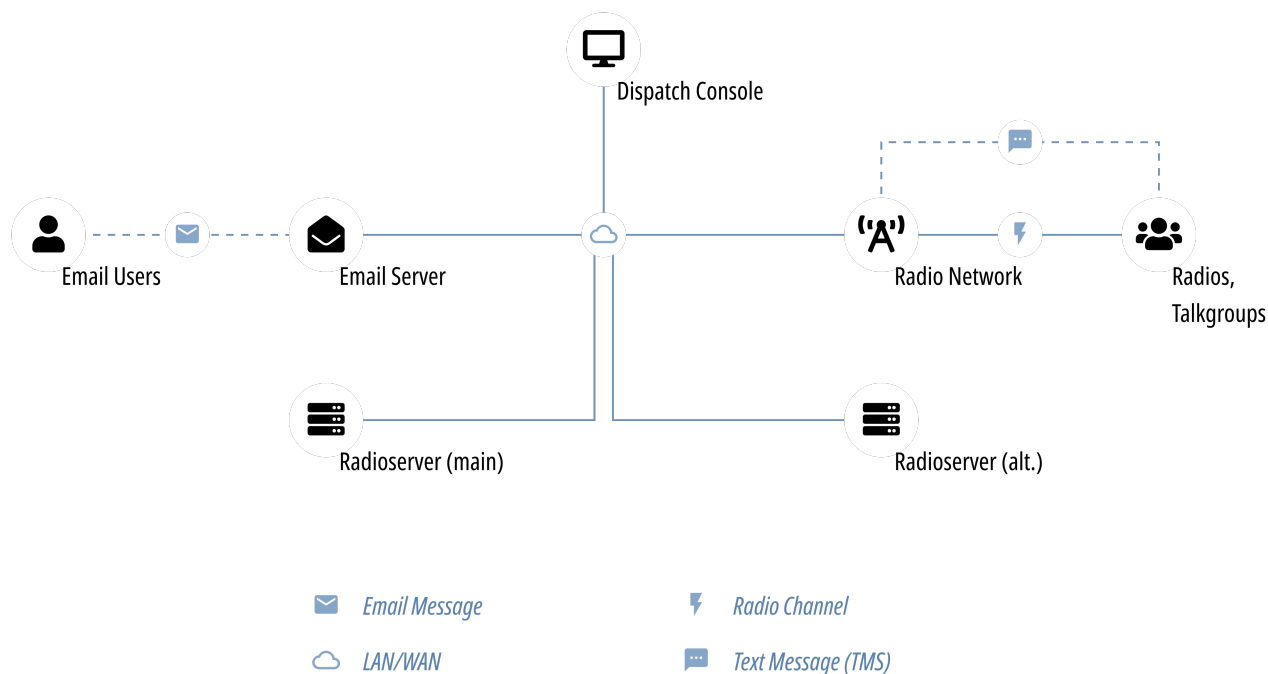

SmartPTT implements the following features when connects email servers:

- Private text messages sent from email addresses.
- Text messages sent from radios to mailboxes.
- Automatic email notifications for pre-configured events:
 - Radio network events (including those related to the radio location). For details, see [Rules](#).
 - Network device alarms. For details, see [Configuring Alarm Notifications](#).
- Text messages monitoring in radio networks:
 - Forwarding text messages intended to be sent from radio network to mailbox.
 - Notifying on text messages in the radio network.

- Automatic deferred actions creation for private text messages which target is currently unavailable.

SmartPTT supports the following standard email communication protocols:

- Internet Message Access Protocol (IMAP4) that is used to receive email messages from email server.
- Post Office Protocol (POP3), an alternative email reception protocol.
- Simple Mail Transfer Protocol (SMTP) that is used to send email messages to email server.

7.1.1 Configuring Message Processing

Follow the procedure to configure email and TMS processing in SmartPTT.

Prerequisites:

- Obtain the radioserver email address.
- Obtain various settings for email and text messages.

Procedure:

1. In SmartPTT Radioserver Configurator, open the **Settings** tab.
2. In the left pane, expand **Radio Network Services**, and then click **Email Gateway**.
The processing settings appear in the right pane.

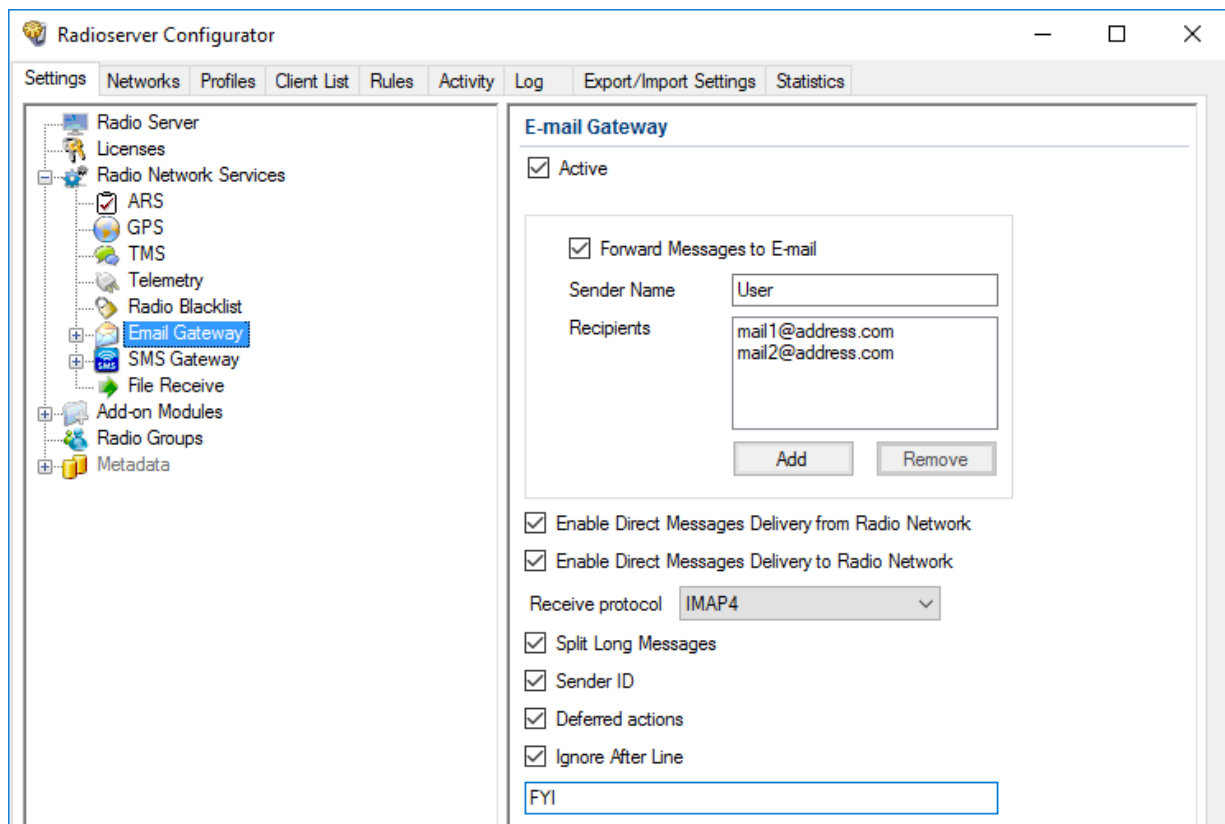

3. In the right pane, select the **Active** check box.
4. Configure text message monitoring:
 - a. Select the **Forward Messages to E-mail** check box.

- b. In the **Sender Name** field, type the radioserver alias that will appear next to its address in forwarded email messages.
- c. Configure email addresses that will receive messages:

To add an address,

perform the following actions:

1. Click **Add**.
Dialog box opens.
2. In the dialog box, in the **Address** field, type the email address, and then click **Add**.



To delete an address,

perform the following actions:

1. In the **Recipients** area, click the required address.
2. In the same area, click **Remove**.

-
5. Select the **Enable Direct Message Delivery from Radio Network** check box to forward text messages from radio networks as email messages.
 6. Select the **Enable Direct Message Delivery to Radio Network** check box to forward email messages as text messages to radio networks.
 7. *(Optional)* Configure miscellaneous features related to message processing:
 - a. Select the **Split Long Messages** check box to forward long email messages as multiple text messages to radio networks.
 - b. Select the **Sender ID** check box to include sender email addresses into text messages.
 - c. Select the **Deferred actions** check box to monitor radios presence in radio networks and send text messages only to the registered radios.
 8. *(Optional)* Configure character sequence that precedes the email text that must not be sent as a text message:
 - a. Select the **Ignore After Line** check box.
 - b. In the field under the check box, type the character sequence.
 9. To save changes, at the bottom of the SmartPTT Radioserver Configurator window, click **Save Configuration** ().

Postrequisites:

- To apply changes immediately, at the bottom of the SmartPTT Radioserver Configurator window, click **Start** () or **Restart** ().
- Connect radioserver to the POP/IMAP service (incoming email service). For details, see [Connecting to POP/IMAP Services](#).
- Connect radioserver to the SMTP service (outgoing email service). For details, see [Connecting to SMTP Services](#).

7.1.2 Connecting to POP/IMAP Services

Follow the procedure to configure SmartPTT connection to the incoming email message service that uses POP3 or IMAP4.

Prerequisites:

- Obtain the incoming message service information:
 - Allowed protocol (POP or IMAP).
 - Domain name and port number for third-party applications (including a radioserver).
 - TLS/SSL necessity.
 - Radioserver authentication credentials (email address and password).
- Activate email server support in SmartPTT. For details, see [Configuring Message Processing](#).

Procedure:

1. In SmartPTT Radioserver Configurator, open the **Settings** tab.
2. In the left pane, expand **Radio Network Services**, and then click **Email Gateway**.
3. In the right pane, from the **Receive protocol** list, select the proper option:

If incoming message service supports IMAP4,	select <i>IMAP4</i> .
---	-----------------------

If incoming message service supports only POP3,	select <i>POP3</i> .
---	----------------------

- In the left pane, expand the **Email Gateway** node, and then click **Settings**.

The service connection settings appear in the right pane.

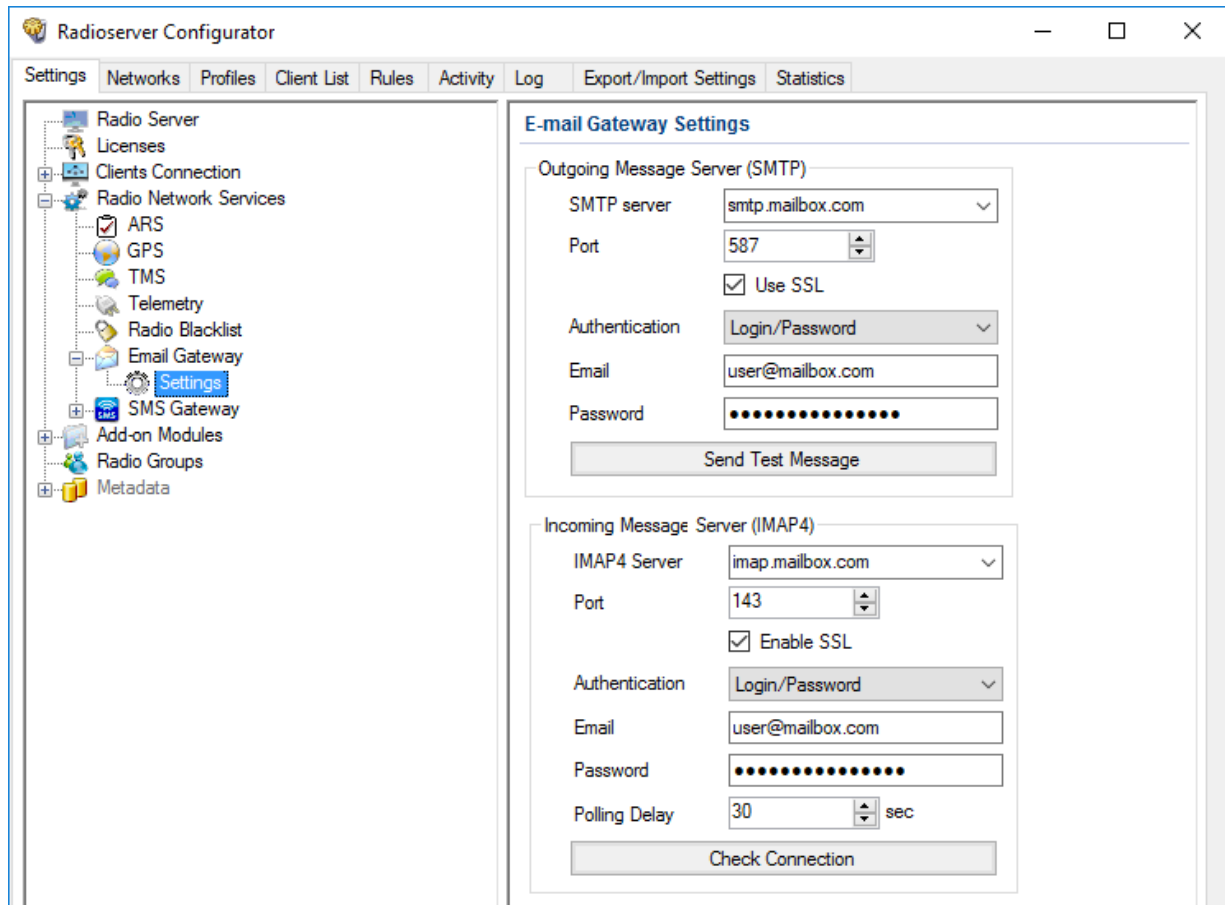

- In the right pane, in the **Incoming Message Server** area, perform one of the following actions:

If the **IMAP4 Server** field appears, _____ in the field, enter the IMAP service domain name.

If the **POP3 Server** field appears, _____ in the field, enter the POP service domain name.

- In the **Port** field, enter the port number allocated in the email server for radioserver connections.
- If the service requires secure connection, select the **Enable SSL** check box.
- In the **Authentication** list, configure the radioserver authentication in the service:

If the service requires login and password, _____ perform the following actions:



- Select *Login/Password*.
- In the **Password** field, type the password.

If the service allows anonymous connections (without authentication), _____ select *Anonymous*.

- In the **Email** field, type the radioserver email address.
- In the **Polling Delay** field, enter the service polling interval.

11. (Optional) Click **Check Connection** to check the service connection.
12. To save changes, at the bottom of the SmartPTT Radioserver Configurator window, click **Save Configuration** ().

Postrequisites:

To apply changes immediately, at the bottom of the SmartPTT Radioserver Configurator window, click **Start** () or **Restart** (.

7.1.3 Connecting to SMTP Services

Follow the procedure to connect SmartPTT to the SMTP service for message sending to mailboxes.

Prerequisites:

- Obtain information on the SMTP service:
 - Domain name and port number allocated in the email server for radioserver connection.
 - TLS/SSL necessity.
 - Radioserver authentication credentials (email address and password).
- Activate email server support. For details, see [Configuring Message Processing](#).

Procedure:

1. In SmartPTT Radioserver Configurator, open the **Settings** tab.
2. In the left pane, expand **Radio Network Services** → **Email Gateway**, and then click **Settings**. The SMTP service connection settings appear in the right pane.

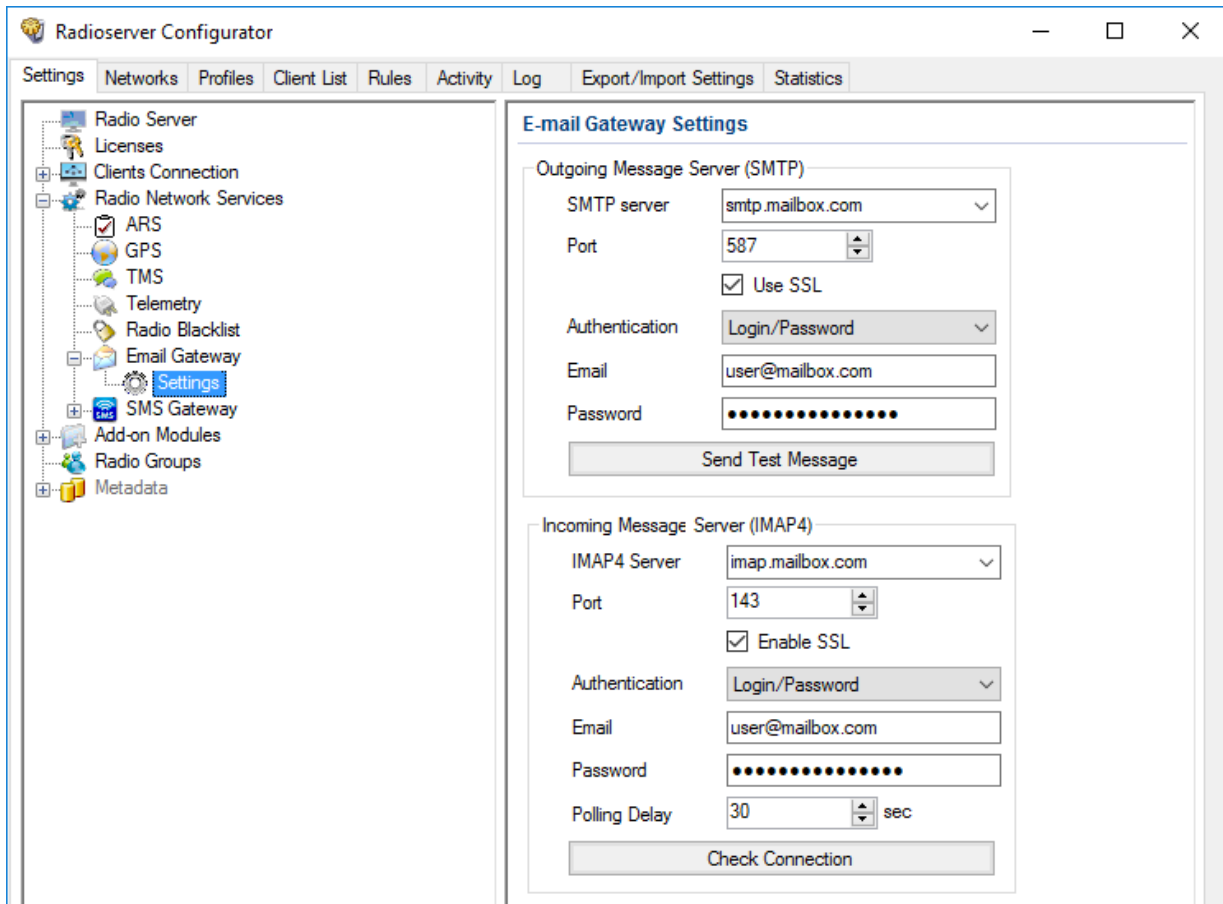

3. In the right pane, in the **Outgoing Message Server (SMTP)** area, in the **SMTP server** field, enter the SMTP service domain name.

NOTE

You may also select one of the popular public SMTP service provided in the field.

4. In the **Port** field, enter the port number allocated in the email server for radioserver connection.
5. If the SMTP service requires a secure connection, select the **Use SSL** check box.
6. In the **Authentication** list, configure SmartPTT authentication in the SMTP service:

If the SMTP service accepts domain and/or local credentials, select *Windows*.



If the SMTP service uses its own authentication, perform the following actions:

1. Select *Login/Password*.
 2. In the **Password** field, type the radioserver mailbox password.
-

If the SMTP service allows anonymous connection (without authentication), select *Anonymous*.

7. In the **Email** field, type the radioserver email address.
8. (Optional) Click **Send Test Message** to check the SMTP service connection.
9. To save changes, at the bottom of the SmartPTT Radioserver Configurator window, click **Save Configuration** ().

Postrequisites:

To apply changes immediately, at the bottom of the SmartPTT Radioserver Configurator window, click **Start** () or **Restart** ().

7.1.4 Email Message Requirements

Email message can be sent to one or several radios as well as to one or several talkgroups. Email message that is sent from a mailbox to a radio network, must comply with the following requirements:

- Must be addressed to SmartPTT Radioserver mailbox.
- Must be a plain text message. No HTML or RTF formatting must be applied to it.
- Must use the UTF-8 encoding.
- Message text must have specific structure:
 - Message text must start with a colon (:).
 - Right after the colon, target ID must be entered.
 - Right after the ID, a space must be entered.
 - Right after the space, a character or message text must be entered.

Important

«New line» symbol must never be placed after or instead of the space.

- If the email-message must be sent to several receivers, their identifiers must be divided by commas.

Target ID can be entered in different form (depends on the target type). To send a message to a radio, one of the following formation must be used:

- Decimal number (if radio ID ranges from 1 to 255).
- IP address in dot-decimal notation (applicable to any value). For details, see [ID-to-IP Conversion](#).

To send a message to a talkgroup, IP address in dot-decimal notation (applicable to any value) must be used only. For details, see [ID-to-IP Conversion](#).

Important

Messages addressed to the All Call ID will not be sent.

EXAMPLE

- The “call back to radio 1” message must be sent to the radio IDs = 200, 201, 202. Email text must be as follows
:200,201,202 call back to radio 1
- The “call back to radio 1” message must be sent to the radio ID = 1001. Email text must be as follows
:12.0.3.233 call back to radio 1
- The “call back to radio 1” message must be sent to the talkgroup ID = 1001. Email text must be as follows
:225.0.3.233 call back to radio 1

7.1.5 TMS Requirements

Text message that is sent from radio and intended to be delivered to email, must be sent to the radio ID assigned to the radioserver.

Text message content must comply with the following requirements:

- Message must start with a colon (:).
- Target mailbox must be entered right after the colon. Input format is
<user name>@<domain name>
- If a message must be sent to multiple email addresses, other mailboxes must be entered comma-separated. No spaces must be used between commas and mailboxes.
- After the last mailbox, a space must be entered.
- Right after the space, a printed symbol or message text must be entered.

EXAMPLE

- The “available” text must be sent to a mailbox from a radio. TMS text must be as follows
:user@mailbox.com available
- The “available” text must be sent to multiple mailboxes. TMS text must be as follows
:user1@mailbox.com,user2@mailbox.com avaialbe

7.2 Mobile Phone Networks

SmartPTT supports the mobile phone network access for text-based communication and notifications.

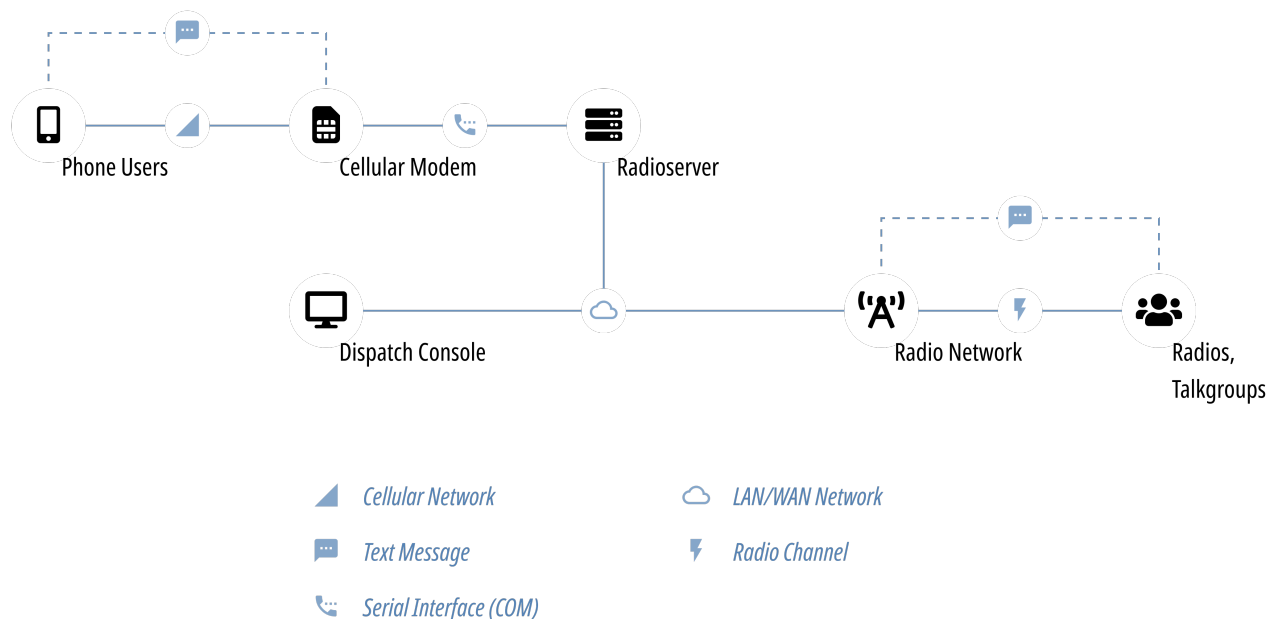

Phone network access provides the following features in SmartPTT:

- Private and group text messages from the phone network to radio networks.
- Short text messages from radio networks to the phone network.
- Automatic notifications to the phone network for various events:
 - Specific events in the radio network (emergency alarms, specific location updates). For details, see [Rules](#).
 - Radio network infrastructure alarms. For details, see [Configuring Alarm Notifications](#).
- Private message delivery deference if the target radio is offline.

To access the phone network, SmartPTT uses phone network modems. The modems must be connected over the COM port of the radioserver host. For details, submit a request to the [SmartPTT Technical Support Center](#).

7.2.1 Configuring SMS and TMS Processing

Follow the procedure to configure SMS and TMS messages processing in a radioserver.

Prerequisites:

Determine various processing parameters.

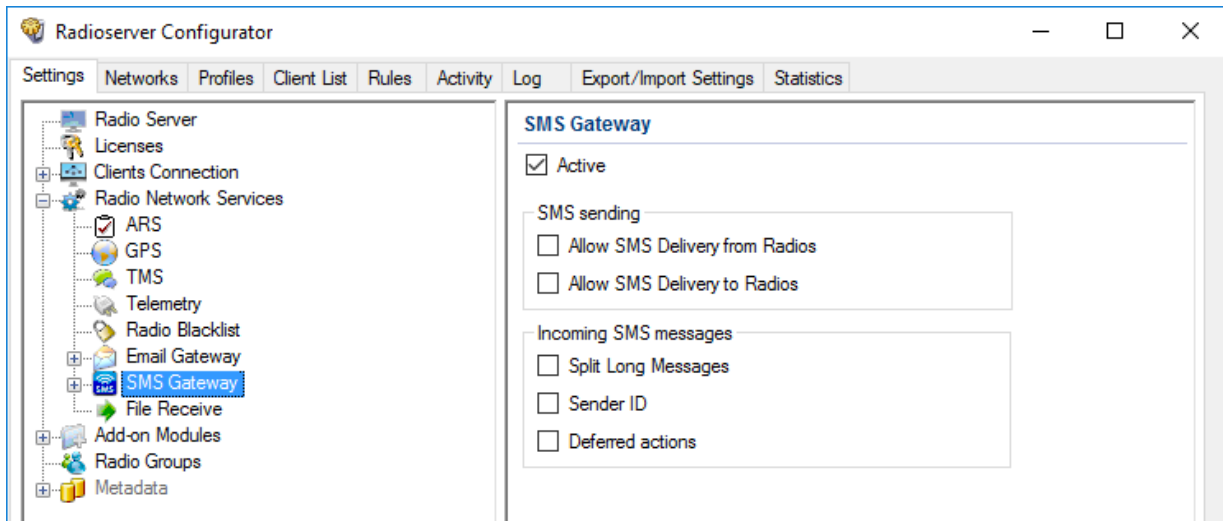

Procedure:

1. In SmartPTT Radioserver Configurator, open the **Settings** tab.
2. In the left pane, expand **Radio Network Services**, and then click **SMS Gateway**.
The message processing settings appear in the right pane.



3. In the right pane, select the **Active** check box.
4. (Optional) Configure message exchange between the phone network and radio networks:
 - a. Select the **Allow SMS Delivery from Radios** check box to allow TMS messages forwarding to the phone network as SMS messages.
 - b. Select the **Allow SMS Delivery to Radios** check box to allow SMS messages forwarding to radio networks as one or multiple SMS messages.
5. (Optional) Configure various SMS processing parameters:
 - a. Select the **Split Long Messages** check box to forward a long SMS message as multiple TMS messages.
 - b. Select the **Sender ID** check box to include the initiator phone number into TMS messages.
 - c. Select the **Deferred Actions** check box to store SMS messages addressed to currently inactive radios until the radios become available in the radio network.
6. To save changes, at the bottom of the SmartPTT Radioserver Configurator window, click **Save Configuration** ().

Postrequisites:

To apply changes immediately, at the bottom of the SmartPTT Radioserver Configurator window, click **Start** () or **Restart** ().

7.2.2 Connecting to Phone Modems

Follow the procedure to configure the radioserver connection to the phone modem.

Prerequisites:

- Determine the protocol parameters for radioserver and modem communication over the COM port.
- Connect a modem to the radioserver COM port.
- Stop the radioserver by clicking the **Stop** () button in the bottom part of SmartPTT Radioserver Configurator.
- Activate the phone modem support in SmartPTT. For details, see [Configuring SMS and TMS Processing](#).

Procedure:

1. In SmartPTT Radioserver Configurator, open the **Settings** tab.
2. In the left pane, expand **Radio Network Services** → **SMS Gateway**, and then click **Modem Settings**. The modem settings appear in the right pane.

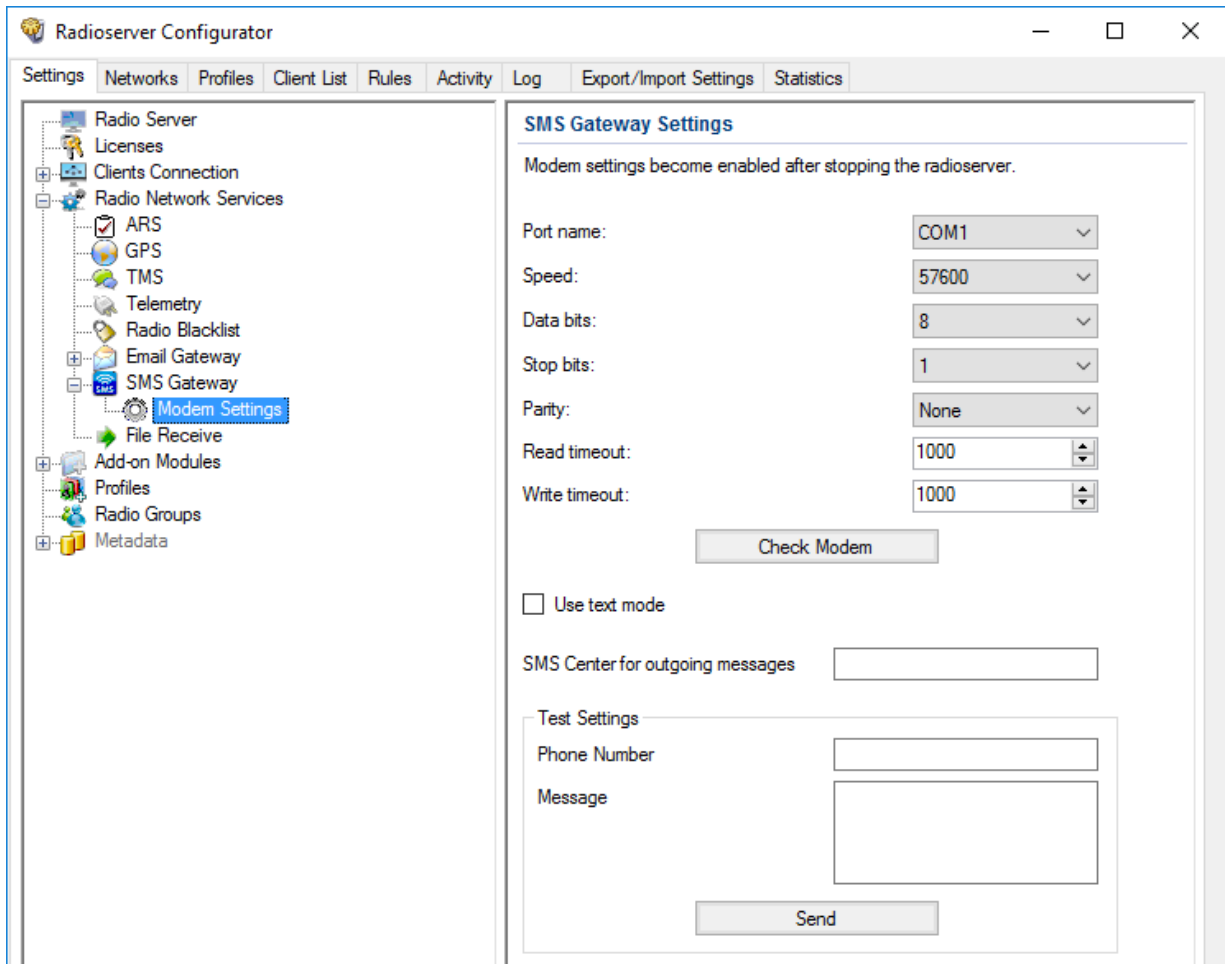

3. In the right pane, from the **Port Name** list, select the COM port name to which the modem is connected.
4. Configure the communication parameters for the port:
 - a. From the **Speed** list, select the baud rate for data exchange between the radioserver and the modem.
 - b. From the **Data bits** list, select the number of bits encoded in each symbol of the protocol.
 - c. From the **Stop bits** list, select the stop bits length.
 - d. From the **Parity** list, select the data consistency method:

If each symbol must contain (after the consistency validation) the odd number of bits, select *Odd*.

If each symbol must contain (after the consistency validation) the even number of bits, select *Even*.



If data validation must not be used, select *None*.

- e. In the **Read timeout** field, enter the data reading timeout.
- f. In the **Write timeout** field, enter the data writing timeout.
5. (Optional) Click **Check modem** to test the communication parameters correctness.
6. Configure the charset that will be used in SMS and TMS messages:

If ASCII characters only should be used,	select the Use text mode check box.
If non-ASCII character letters should also be used,	clear the Use text mode check box.

7. In the **SMS Center for outgoing messages** field, type the SMS service number in the mobile operator infrastructure.
8. To save changes, at the bottom of the SmartPTT Radioserver Configurator window, click **Save Configuration** ().

Postrequisites:

- To apply changes immediately, at the bottom of the SmartPTT Radioserver Configurator window, click **Start** () or **Restart** ().
- Test the modem configuration correctness by sending test messages. For details, see [Testing Modem Operation](#).

7.2.2.1 Testing Modem Operation

Follow the procedure to test the modem configuration correctness by sending test messages.

Important

Sending SMS messages can be the billed phone network feature determined in your contract.

Prerequisites:

- Configure the modem connection to the radioserver. For details, see [Connecting to Phone Modems](#).
- Ensure that the modem antenna is within the phone network coverage zone.
- Determine a phone number that is intended to receive a test message.
- Stop the radioserver by clicking the **Stop** () button in the bottom part of SmartPTT Radioserver Configurator.

Procedure:

1. In SmartPTT Radioserver Configurator, open the **Settings** tab.
2. In the left pane, expand **Radio Network Services** → **SMS Gateway**, and then click **Modem Settings**. The connection settings appear in the right pane.

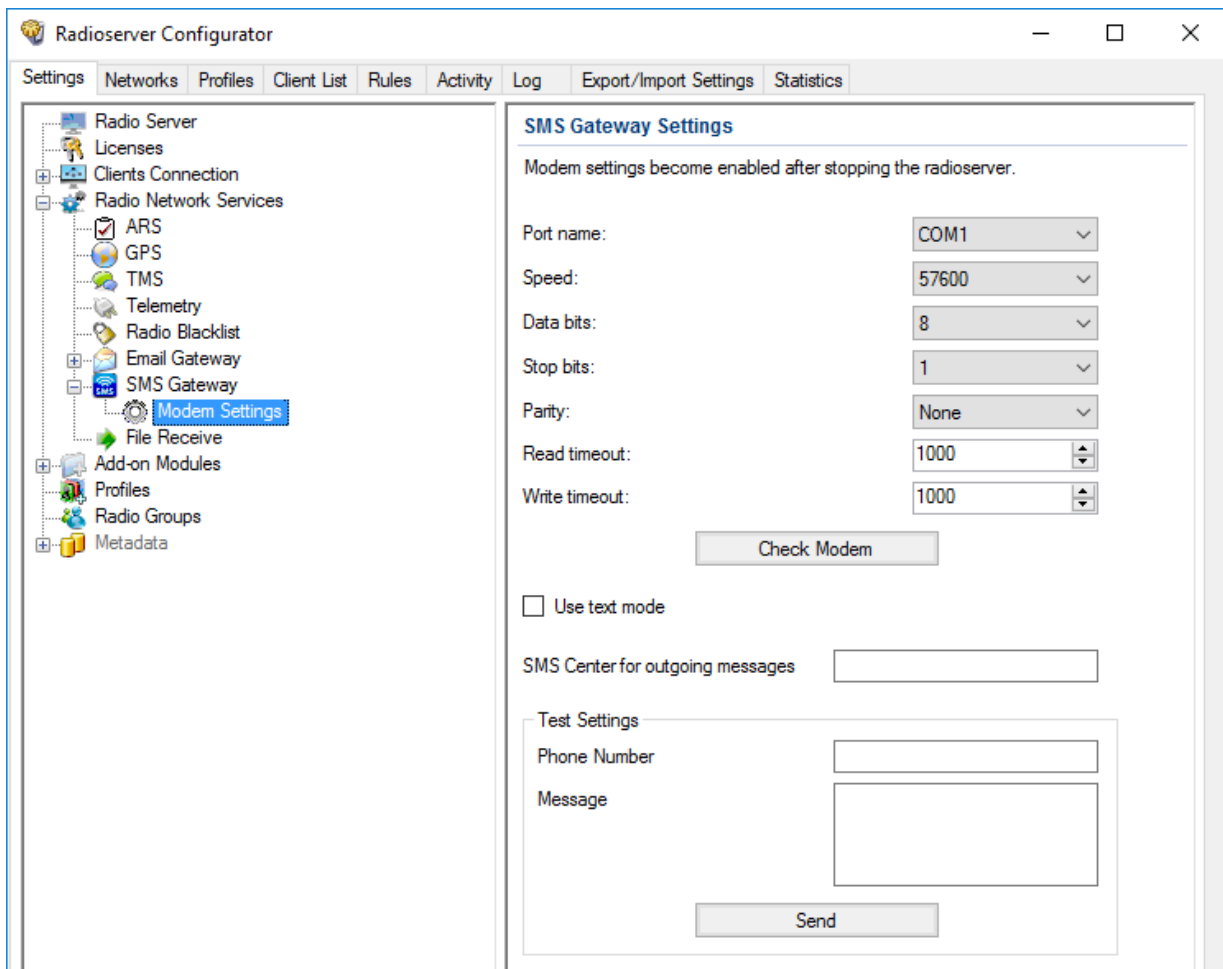

3. In the right pane, in the **Test Settings** area, in the **Phone Number** field, type the phone number that is intended to receive a test message.
4. In the **Message** field, type the text of the message.
5. Click **Send**.
6. Wait for the SMS message reception. If the message is not received within several minutes, submit an assistance request to the [SmartPTT Technical Support Center](#).
7. (Optional) To save changes, at the bottom of the SmartPTT Radioserver Configurator window, click **Save Configuration** ().

7.2.3 SMS Messages for Radio Networks

If an SMS message must be delivered from the mobile network to a radio network, the message must comply with the following requirements:

- Message must be sent to the number that is programmed in the SIM card that is installed in the phone modem.
- Message text must be specific.

Message text must comply with the following requirements:

- It must start with the colon character (:).

- After the colon, a target must be entered. No spaces must be between the target and a colon.
- After the target, a space must be entered.
- After the space, any printed character or message text must be entered.

Important

You must **not** start a new line after or instead of the space character.

Depending on the target type, it must be specified differently. To send a message to a radio, one of the following formats must be used:

- Decimal number (if the radio ID is in the range of 1 to 255).
- IP address (for any radio ID values). For details, see [ID-to-IP Conversion](#).

To send a message to a talkgroup, the talkgroup IP address must be used as a target. For details, see [ID-to-IP Conversion](#).

Important

Text messages cannot be sent to All Call IDs.

EXAMPLE

- Message text is "call to radio 1" and the target radio ID is 200. SMS message text must be as follows:
:200 call to radio 1
- Message text is "call to radio 1" and the target radio ID is 1001. SMS message text must be as follows:
:12.0.3.233 call to radio 1
- Message text is "call to radio 1" and the target talkgroup ID is 1001. SMS message text must be as follows:
:225.0.3.233 call to radio 1

7.2.4 TMS Messages for Phone Networks

If a text message must be delivered from a radio network to the phone network over the radioserver, it must be sent to the radio ID assigned to the radioserver.

Message text must comply with the following requirements:

- Message text must start with the colon character that follows with the ampersand characters (:&).
- Right after the ampersand, a phone number must be entered in the following format:
 - Only digits must be left. Other characters must be removed (includes, spaces, brackets, hyphens etc.).
 - Phone number prefix (+) must not be used.
- Right after the number, a space must be entered.
- Right after the space, any printed character or message text must be entered..

EXAMPLE

- The “available” message must be delivered to the phone number +1 909 909 9009. Message text must be as follows:
:&19099099009 available

7.3 SmartPTT File Transfer

SmartPTT supports file transfer using the SmartPTT File Transfer software. This feature can be necessary when there is no Internet connection.

You can download software for transferring files over the radio network based on MOTOTRBO radios on the [SmartPTT File Transfer](#) page of the SmartPTT website. For information on SmartPTT File Transfer, see also the SmartPTT File Transfer embedded help or *SmartPTT File Transfer User Guide*.

SmartPTT File Transfer provides the ability to transfer files of any format:

- between MOTOTRBO Motorola radios;

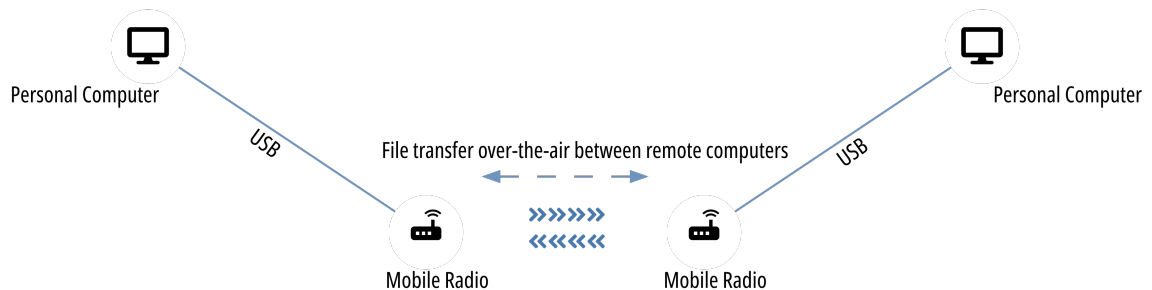

- from MOTOTRBO radios, connected to a PC via USB port, to the SmartPTT Radioserver host.

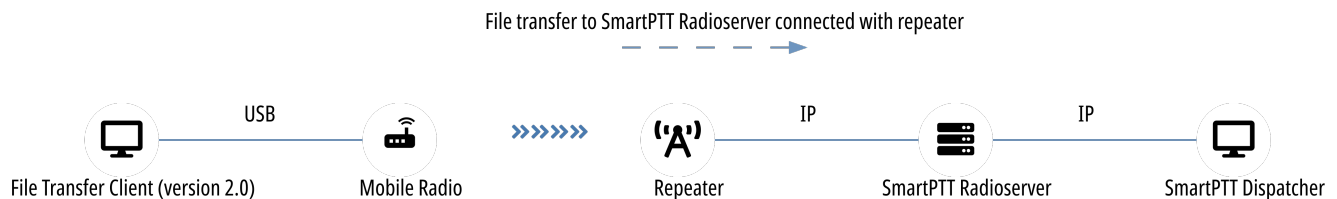

To transfer files you must have the following:

- MOTOTRBO radios
- PCs that are running Microsoft Windows
- The installed .NET Framework that is not lower than version 4.0
- The installed SmartPTT File Transfer application version 2.0
- Free USB port and programming cable for MOTOTRBO radios
- MOTOTRBO repeater and a computer with a radioserver installed (to transfer files to SmartPTT Dispatcher).



7.3.1 Configuring File Receive

Follow the procedure to configure the File Receive service in SmartPTT Radioserver Configurator.

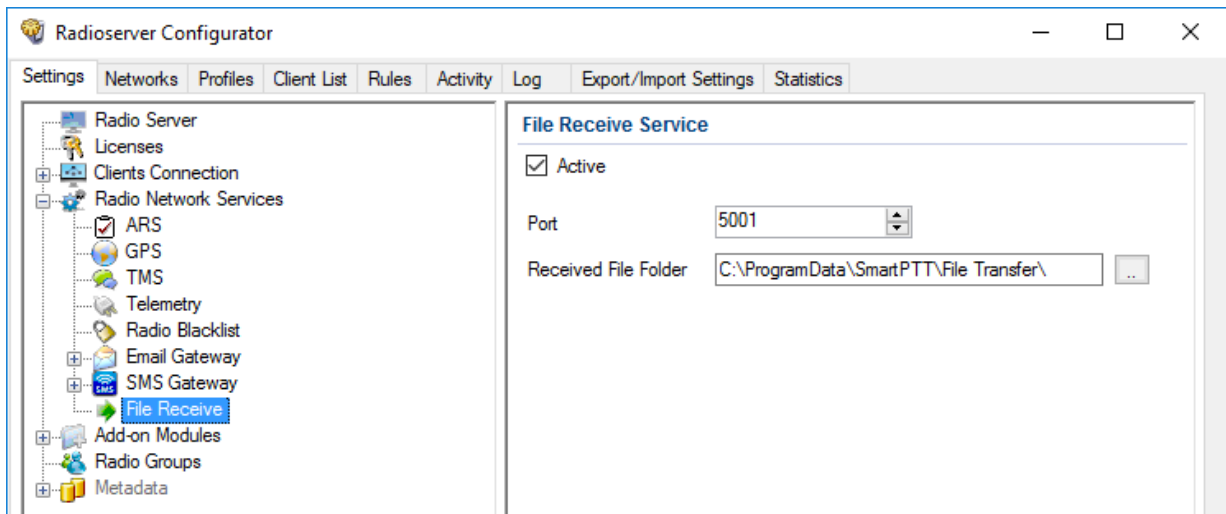

Procedure:

1. In SmartPTT Radioserver Configurator, open the **Settings** tab.
2. In the **Settings** tab, expand the **Radio Network Services** node, and then click **File Receive**.
The **File Receive Service** pane appears.



3. Select the **Active** check box to activate the service.
4. In the **Port** field, enter the port number for the File Receive service.
5. Next to the **Received File Folder** field, click Browse (), and then specify the folder name where the received files are to be stored.
6. To save changes, at the bottom of the SmartPTT Radioserver Configurator window, click **Save Configuration** ().

Postrequisites:

- To apply changes immediately, at the bottom of the SmartPTT Radioserver Configurator window, click **Start** () or **Restart** ().
- To transfer files, install the SmartPTT File Transfer application version 2.0.
For information on SmartPTT File Transfer, see the SmartPTT File Transfer embedded help.

7.4 Avigilon

SmartPTT supports integration with the Avigilon video monitoring system. It helps dispatchers to monitor online what is happening at one or another object, for example, if alarm is received from a radio, thus allowing to know the situation at the object.

To integrate cameras with SmartPTT Dispatcher, Avigilon Control Center Server 7 Software must be installed. For details, see the [Avigilon Control Center 7 Software](#) web page on the Avigilon website.

To integrate with the Avigilon system, the corresponding license must be installed. For details, see [Installing License](#).

To watch live video from cameras, perform the following:

- Install Avigilon Control Center Server 7 software.
- Add cameras to the Avigilon system.
- Install the corresponding license.
- Connect SmartPTT to the Avigilon system. For details, see [Configuring Avigilon Connection](#).
- Add cameras on a map in SmartPTT Dispatcher. For information on working with cameras, see the "Cameras" section of *SmartPTT Dispatcher Guide*.

NOTE

Video recording in the SmartPTT system is not available.

7.4.1 Configuring Avigilon Connection

Follow the procedure to configure SmartPTT connection to the Avigilon system.

Prerequisites:

- Ensure the SmartPTT license allows connection to Avigilon. For details, see [Viewing License Items](#).
- Obtain the user name and password that will be used to authenticate in the Avigilon system.
- Obtain the Avigilon IP address and port for SmartPTT connecting to it.

Procedure:

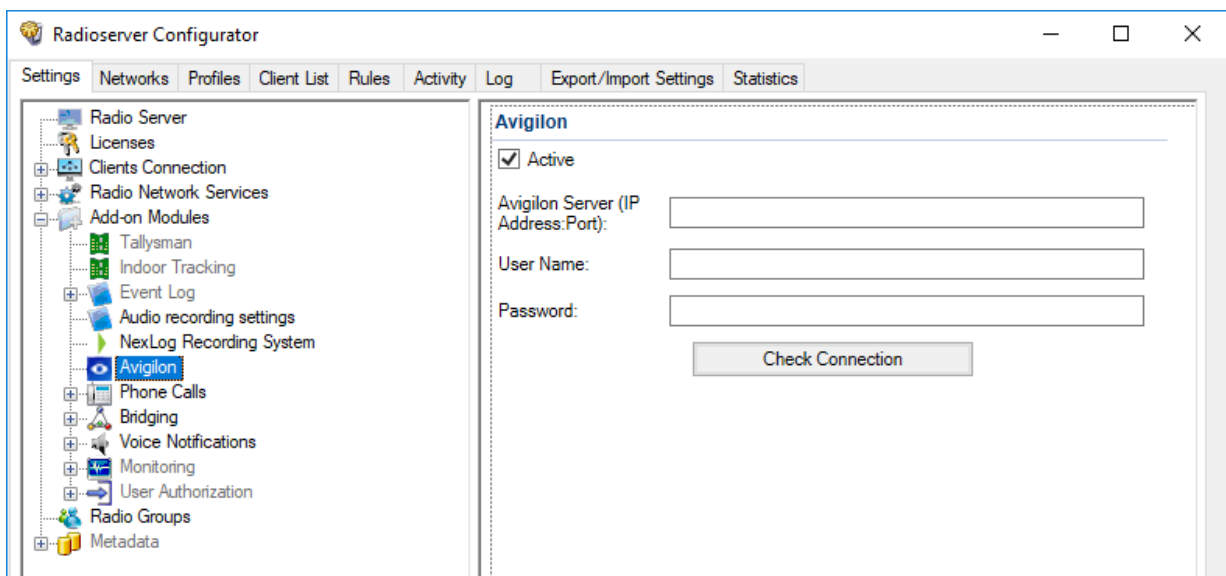

1. In SmartPTT Radioserver Configurator, open the **Settings** tab.
2. In the left pane of the tab, expand the **Add-on Modules** node, and then click **Avigilon**.
Connection settings to the system appear in the right pane of the tab.



3. In the right pane of the tab, select the **Active** check box.
4. In the **Avigilon Server (IP Address:Port)** field, type the IP address of the Avigilon server for SmartPTT connecting to it.

5. In the **User Name** field, type the user name that SmartPTT will use for authentication on the Avigilon server.
6. In the **Password** field, type the password set for the specified user on the Avigilon server.
7. Press the **Check Connection** button to check the connection status to the Avigilon server.
8. To save changes, at the bottom of the SmartPTT Radioserver Configurator window, click **Save Configuration** ().

Postrequisites:

To apply changes immediately, at the bottom of the SmartPTT Radioserver Configurator window, click **Start** () or **Restart** ().

7.5 ID-to-IP Conversion

In some cases, radio IDs and talkgroup IDs must be represented as IP addresses. Examples of such cases is as follows:

- SMS messages sent from a mobile phone to the radio network over SmartPTT.
- During the SmartPTT Radioserver activity events analysis.

In SmartPTT, ID representation as an IP address implies the dot-decimal notation. It means that each ID is represented as four decimal numbers (octets) separated by dots. Each decimal number ranges from 0 to 255. Example of the IP address is 255.255.255.0.

Radio IDs

To convert a radio ID to IP address (using dot-decimal notation), the following actions must be performed:

1. Radio ID must be converted from a decimal number to a hexadecimal number.

EXAMPLE

Radio ID is equal to *1001*. In hexadecimal form, it is equal to *3E9*.

2. The converted ID must be represented as a six-position hexadecimal number.

EXAMPLE

The ID is equal to *3E9*. In a six-position form, it is equal to *0003E9*.

3. The six-position ID must be split into three two-position hexadecimal numbers.

EXAMPLE

The six-position hexadecimal number *0003E9* can be split into the following two-position numbers:

- 00
- 03
- E9

- Each two-position hexadecimal number must be converted to a decimal number.

EXAMPLE

- Hexadecimal number 00 is equal to decimal number 0.
- Hexadecimal number 03 is equal to decimal number 3.
- Hexadecimal number E9 is equal to decimal number 233.

Each decimal number is related to the second, third, and fourth octet of the IP address, respectively. The first octet is equal to the CAI of the corresponding radio network.

EXAMPLE

Radio ID is equal to *1001*. Radio is used in a radio network with CAI equal to *12*.

Radio IP address is equal to *12.0.3.233*.

Talkgroup ID

Conversion process for talkgroup IDs is almost the same as for radio IDs. The difference is that Group CAI must be used instead of CAI.

EXAMPLE

Talkgroup ID is equal to *1001*. Group CAI is equal to *225*.

Talkgroup IP address is equal to *225.0.3.233*.

8 SmartPTT Profiling

SmartPTT profiling includes the following actions:

- Client connections configuration. For details, see [Client Connections](#).
- Voice notification configuration. For details, see [Voice Notifications](#).
- SmartPTT bridging configuration. For details, see [Bridging](#).
- Rules configuration. For details, see [Rules](#).
- Network device monitoring configuration. For details, see [Network Monitoring](#).
- Firewall configuration. For details, see [Firewall Configuraiton](#).

Unnecessary and/or not licensed actions can be skipped without SmartPTT damage and performance.

All of those actions depend on the communication system connect settings. They cannot be performed before the connection for various reasons:

- During the bridging configuration, specific control stations, IP Site Connect slots, or trunked radio systems must be available to select.
- During the rules configuration, specific talkgroups and radio systems must be available to select.
- For the monitoring configuration, radioserver must be connected to the required control stations and repeater systems. It is required because all other network devices (repeaters, UPS, routers) are connection-specific.

8.1 Client Connections

SmartPTT supports different types of clients. They are as follows:

- SmartPTT Dispatcher applications (also known as “desktop clients”). For details, see [Desktop Clients](#).
- SmartPTT Web Clients. For details, see [Web Clients](#).
- SmartPTT Mobile applications. For details, see [SmartPTT Mobile](#).
- SmartPTT SCADA. For details, see [SmartPTT SCADA](#).
- Third-party applications that use Server API. For details, see [Third-Party Apps](#).

8.1.1 Desktop Clients

In SmartPTT, desktop client means SmartPTT Dispatcher, a primary client application in SmartPTT.

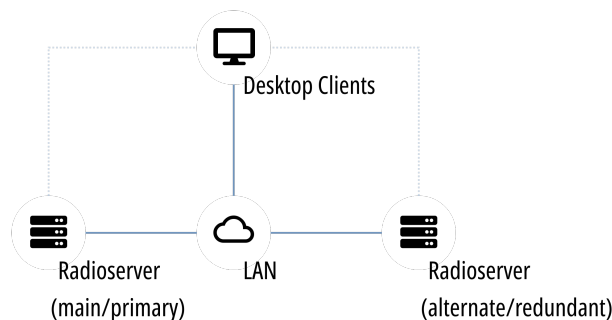

Examples of the SmartPTT Dispatcher capabilities are as follows:

- Voice and data communication in radio networks, phone networks, and with other dispatchers.
- Radio networks integration using bridging, cross patches, and conference calls.
- Tracking radios on maps, creating geofences, and points of interest.
- Network device monitoring tools.
- Reports generation on the radio network events and network devices performance.

For information on the application capabilities, see *SmartPTT Dispatcher Guide*.

Radioserver Configuration

Configuration can be performed in two ways:

- With client authorization on SmartPTT Radioserver. Authorization on SmartPTT Radioserver is performed according to the client credentials, the list of which is configured on the **Clients** tab of SmartPTT Radioserver Configurator, and provides the ability to restrict client access to the SmartPTT Radioserver data.
- Without client authorization.

To allow desktop client connection without authorization, only radioserver network ports must be configured. For details, see [Configuring Desktop Clients Connection](#).

To configure client authorization, the following actions must be performed:

- SmartPTT Radioserver interface must be configured. For details, see [Configuring Desktop Clients Connection](#).
- *(Optional)* Profiles must be created. For details, see [Managing Profiles](#).
- Client accounts must be created. For details, see [Managing Account Parameters](#).
- In SmartPTT Dispatcher, dispatch console accounts must be associated with SmartPTT Radioserver accounts. For details, see *SmartPTT Dispatcher Guide*.

8.1.1.1 Configuring Desktop Clients Connection

Follow the procedure to configure the ability to connect the SmartPTT Dispatcher applications to SmartPTT Radioserver.

Prerequisites:

- Determine the SmartPTT Radioserver host IP address.
- Determine the WCF port and VoIP Listen port numbers for connecting to the application.

Procedure:

1. In SmartPTT Radioserver Configurator, open the **Settings** tab.
2. In the left pane, click **Client Connections**.

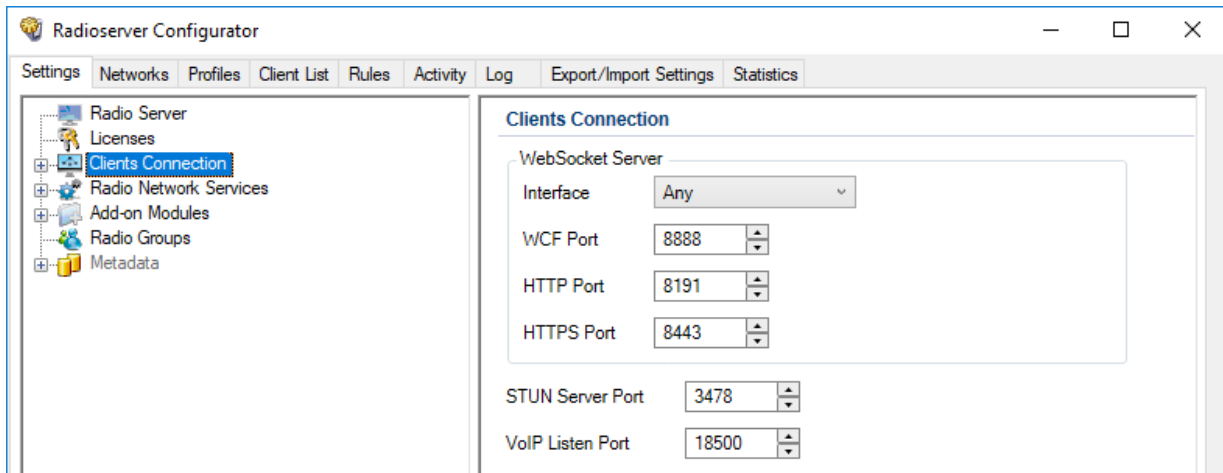

- In the right pane, from the **Interface** list, select the IP address of the SmartPTT Radioserver host to be used for SmartPTT Dispatcher application connection:

To allow SmartPTT Radioserver to accept connection requests to any address of its own, select *Any*.

To allow client applications to connect to SmartPTT Radioserver only through a specific address, select the desired IP address from the list.

- In the **WCF port** field, enter the TCP port number that is used for connecting SmartPTT Dispatcher applications to SmartPTT Radioserver.
- In the **VoIP Listen Port** field, enter the UDP port number that will be used to exchange voice traffic between SmartPTT Radioserver and SmartPTT Dispatcher applications.
- In the left pane, expand the **Client Connections** node.
- Click the **Desktop Clients** node.

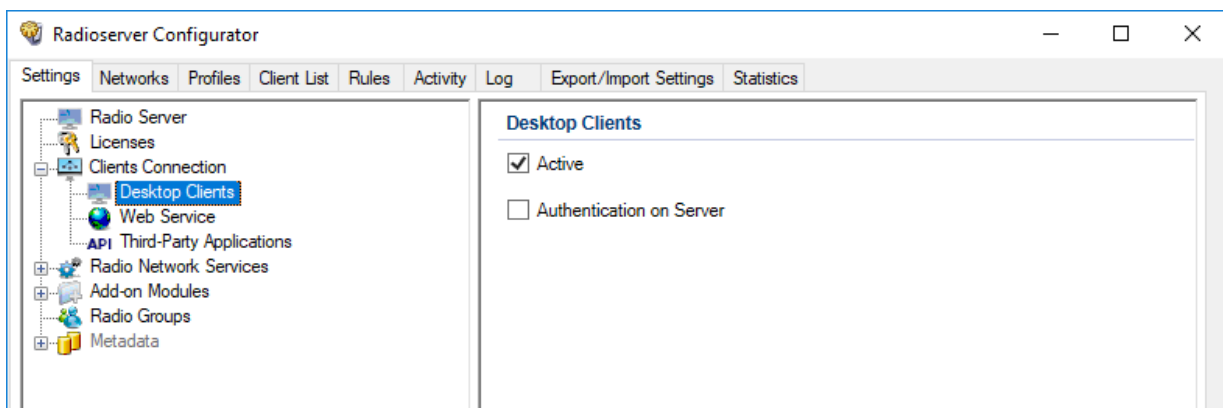

- In the right pane, select the **Active** check box.
- On the tab, perform one of the following actions:



To enable/disable authentication on SmartPTT Radioserver for desktop clients, select the **Authentication on Server** check box.

To allow desktop clients to connect to SmartPTT Radioserver without authentication,

clear the **Authentication on Server** check box.

- To save changes, at the bottom of the SmartPTT Radioserver Configurator window, click **Save Configuration** ().

Postrequisites:

- To apply changes immediately, at the bottom of the SmartPTT Radioserver Configurator window, click **Start** () or **Restart** ().
- If required, in the firewall software, unlock the set TCP and UDP ports.
- Create accounts to authorize in SmartPTT Dispatcher application. For details, see [Managing Account Parameters](#).

8.1.2 Web Clients

SmartPTT provides basic dispatch functions from the web browser. Corresponding application is named SmartPTT Web Client. It is installed together with SmartPTT Radioserver.

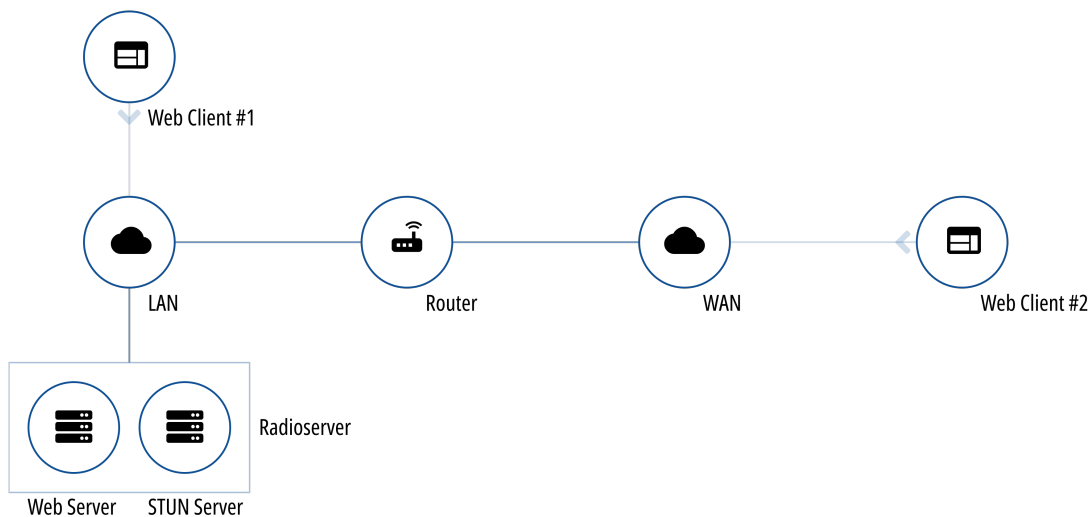

Web Client provides the following features:

- Work on the Internet.
- Voice calls reception and initiation (group and private calls).
- Text messages reception and initiation.
- Showing radios on Google Maps.
- Radioserver access over LAN and WAN.

For detailed information on the Web Client, see *SmartPTT Web Client Guide*.

Radioserver Configuration

To configure Web Clients support on SmartPTT Radioserver, the following actions must be performed:

- Google API key with active billing must be generated. For details, see [Google Map Keys](#).
- SmartPTT license must allow voice and/or data communication for Web Clients. For details, see [Viewing License Items](#).
- (Optional) Profiles must be created and configured. For details, see [Managing Profiles](#).
- Client accounts must be created. For details, see [Managing Account Parameters](#).
- Dedicated SmartPTT Radioserver interface must be configured. For details, see [Configuring Web Client Connection](#).

8.1.2.1 Configuring Web Client Connection

Follow the procedure to configure client connections to support SmartPTT Web Client.

Prerequisites:

- Determine the SmartPTT Radioserver host IP address.
- Determine the HTTPS port, STUN Server port and VoIP Listen port numbers for connecting to SmartPTT Web Client.
- Ensure you have the desired license. For details, see [Installing License](#).
- Obtain a Google API key to unlock Google Maps.

Procedure:

1. In SmartPTT Radioserver Configurator, open the **Settings** tab.
2. In the left pane, click **Client Connections**.

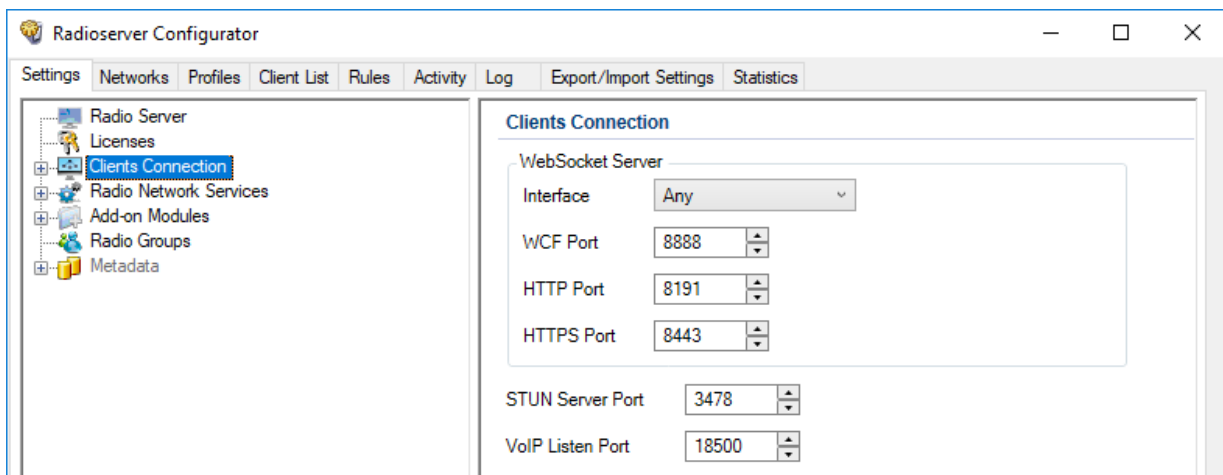



3. If required, in the right pane, from the **Interface** list, select the desired IP address:

To allow SmartPTT Radioserver to accept connection requests to any address of its own, select *Any*.

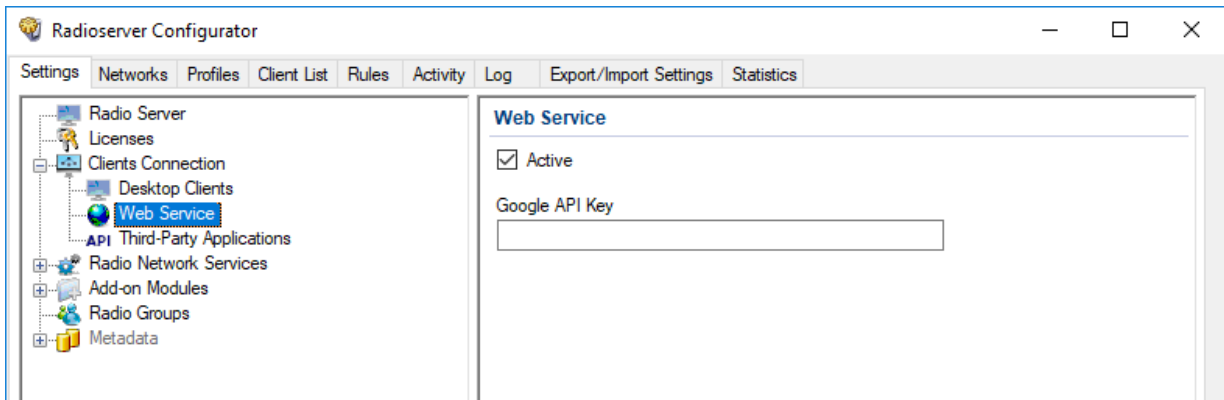

To allow client applications to connect to SmartPTT Radioserver only through a specific address, select the desired IP address from the list.

4. Enter the ports for connecting to web applications:
 - a. In the **HTTPS Port** field, enter the desired value to specify the connection in the SmartPTT Radioserver Local Area Network.
 - b. *(Optional)* In the **STUN Server Port** field, enter the desired value to specify the port number for SmartPTT Web Client connection outside the local network.
 - c. In the **VoIP Listen Port** field, enter the UDP port number that will be used to exchange voice traffic between SmartPTT Radioserver and SmartPTT Web Client.
5. In the left pane, expand the **Client Connections** node.
6. Click the **Web Service** node.



8. In the right pane, select the **Active** check box.
9. In the **Google API Key** field, type Google API key.
10. To save changes, at the bottom of the SmartPTT Radioserver Configurator window, click **Save Configuration** ().

Postrequisites:

- To apply changes immediately, at the bottom of the SmartPTT Radioserver Configurator window, click **Start** () or **Restart** ().
- If required, in the firewall software, unlock the set TCP and UDP ports.
- Create accounts to authorize in SmartPTT Web Client. For details, see [Managing Account Parameters](#).

8.1.3 SmartPTT Mobile

SmartPTT provides basic dispatch functions to SmartPTT Mobile users. SmartPTT Mobile — lightweight application for both Android and iOS operating systems with voice and data communication capabilities. SmartPTT Mobile is distributed via Google Play and App Store.

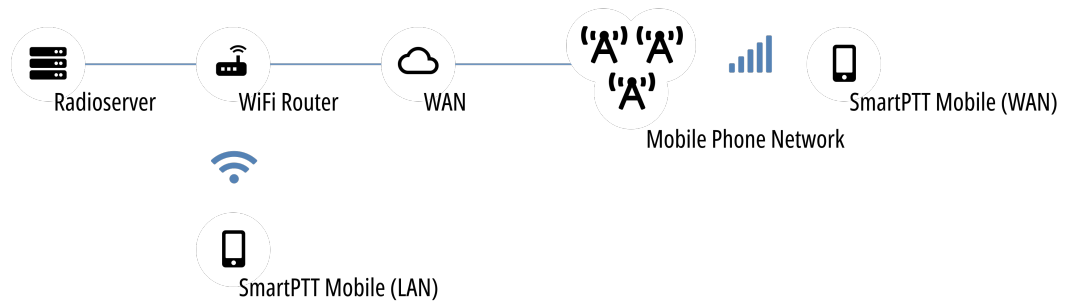

SmartPTT Mobile provides the following features:

- Voice communication with radios and talkgroups (group and private calls).
- Voice communication with other SmartPTT Mobile users (group and private calls).
- Tracking online/offline status of other SmartPTT Mobile users, radios, and virtual talkgroups in real time.
- Ability to create virtual groups for simultaneous voice communication with other SmartPTT Mobile users and DMR talkgroups.

For detailed information on SmartPTT Mobile, see *SmartPTT Mobile User Guide for Android* or *SmartPTT Mobile User Guide for iOS*.

Radioserver Configuration

To configure SmartPTT Mobile support on SmartPTT Radioserver, the following actions must be performed:

- SmartPTT license must allow voice and/or data communication for SmartPTT Mobile. For details, see [Viewing License Items](#).
- Client accounts must be created. For details, see [Managing Account Parameters](#).
- (Optional) Profiles must be created and configured. For details, see [Managing Profiles](#).
- Dedicated SmartPTT Radioserver interface must be configured. For details, see [Configuring SmartPTT Mobile Connection](#).
- Additional configuration of SmartPTT Radioserver must be performed by the [SmartPTT Technical Support Center](#).

8.1.3.1 Configuring SmartPTT Mobile Connection

Follow the procedure to configure client connections to support SmartPTT Mobile. For details, see [SmartPTT Mobile](#).

Prerequisites:

- Determine the SmartPTT Radioserver host IP address.
- Determine the HTTP port and VoIP Listen port numbers for connecting to the mobile application.
- Ensure you have the required license. For details, see [Installing License](#).

Procedure:

1. In SmartPTT Radioserver Configurator, open the **Settings** tab.
2. In the left pane, click **Client Connections**.

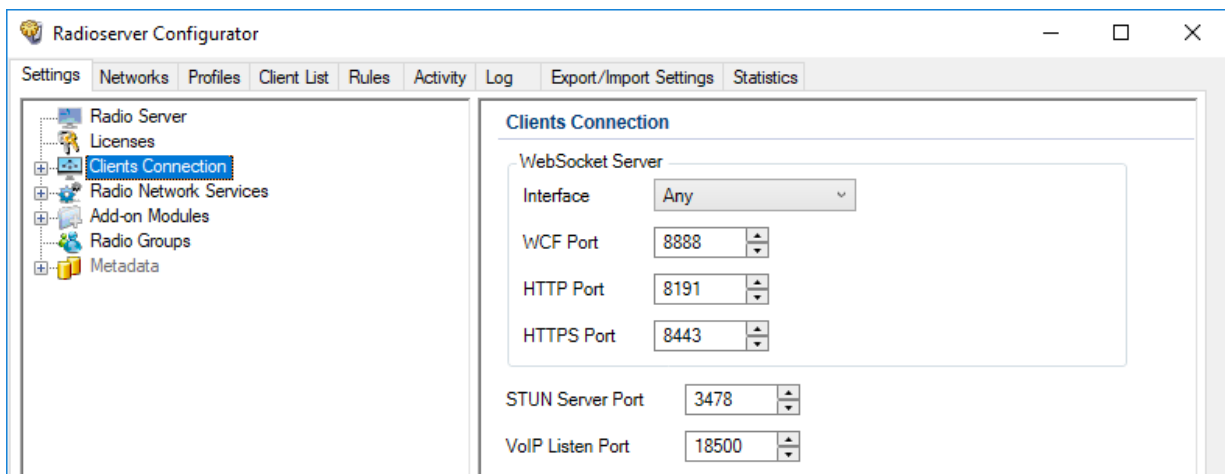



3. If required, in the right pane, from the **Interface** list, select the desired IP address:

To allow SmartPTT Radioserver to accept connection requests to any address of its own, select *Any*.

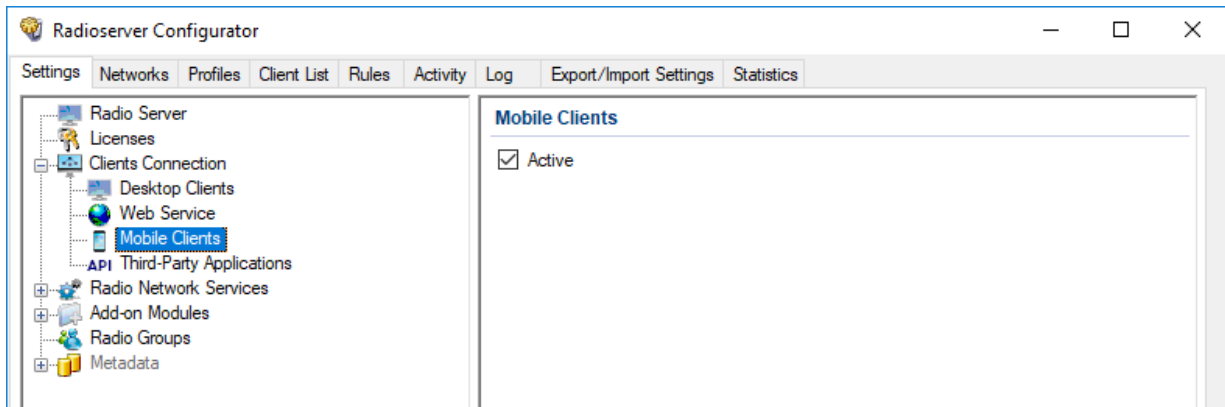

To allow client applications to connect to SmartPTT Radioserver only through a specific address, select the desired IP address from the list.

4. In the **HTTP port** field, enter the desired port number for connecting to SmartPTT Mobile.
5. In the **VoIP Listen Port** field, enter the UDP port number that will be used to exchange voice traffic between SmartPTT Radioserver and SmartPTT Mobile.
6. In the left pane, expand the **Client Connections** node.
7. Click the **Mobile Clients** node.



8. In the right pane, select the **Active** check box.
9. To save changes, at the bottom of the SmartPTT Radioserver Configurator window, click **Save Configuration** ().

Postrequisites:

- To apply changes immediately, at the bottom of the SmartPTT Radioserver Configurator window, click **Start** () or **Restart** ().
- Submit a request to the [SmartPTT Technical Support Center](#) for additional configuration of SmartPTT Radioserver.
- Create accounts to authorize in SmartPTT Mobile. For details, see [Managing Account Parameters](#).
- If required, in the firewall software, unlock the set TCP and UDP ports.
- If required, create and configure a profile. For details, see [Managing Profiles](#).

8.1.4 SmartPTT SCADA

SmartPTT supports SmartPTT SCADA, a data acquisition and remote control software for civil engineering that is developed by Elcomplus LLC.

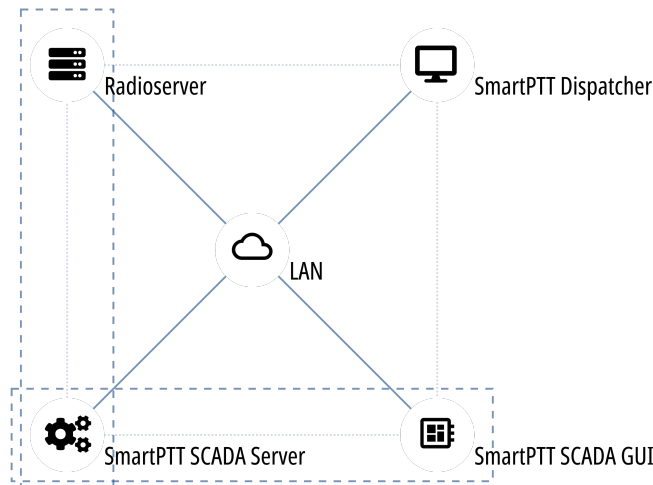

For information on the SmartPTT SCADA, visit [SmartPTT SCADA](#) on the SmartPTT website.

Radioserver Configuration

To configure SmartPTT SCADA support on SmartPTT Radioserver, the following actions must be performed:

- SmartPTT license must allow SmartPTT SCADA connection. For details, see [Installing License](#).
- Client accounts must be created. For details, see [Managing Account Parameters](#).
- Dedicated SmartPTT Radioserver interface must be configured. For details, see [Configuring Third-Party Applications](#).
- After the SmartPTT SCADA connection, SmartPTT Radioserver rules must be configured. For details, see [Rules](#).

8.1.5 Third-Party Apps

SmartPTT provides the platform-independent language-agnostic application programming interface (API). The API allows third-party applications development which includes end-user apps and middleware.



API provides the following capabilities to developers:

- SmartPTT Radioserver connection over the WebSocket protocol.
- Asynchronous data exchange with SmartPTT Radioserver using JSON-like messages.
- Voice and data exchange.
- Software Development Kit (SDK) access that includes traffic analyzer and embedded documentation.

For information on SDK and API, submit a request to [SmartPTT Technical Support Center](#).

Radioserver Configuration

To configure third-party applications on SmartPTT Radioserver, the following actions must be performed:

- SmartPTT license must allow API usage. For details, see [Installing License](#).
- *(Optional)* Profiles must be created and configured. For details, see [Managing Profiles](#).
- Client accounts must be created. For details, see [Managing Account Parameters](#).
- Dedicated SmartPTT Radioserver interface must be configured. For details, see [Configuring Third-Party Applications](#).

8.1.5.1 Configuring Third-Party Applications

Follow the procedure to configure client connections to support third-party applications that use Server API.

This procedure is also applied for SmartPTT SCADA. For supporting SmartPTT SCADA, SmartPTT release must be at least 9.4 version.

Prerequisites:

- Determine the SmartPTT Radioserver host IP address.
- Determine the HTTP port number for connecting to the desired application.
- If third-party applications support voice transmission, determine the VoIP Listen port number.
- Ensure you have the desired licenses:
 - API license (for the third-party application connection).
 - API and SCADA licenses (for the SmartPTT SCADA support).

For details, see [Installing License](#).

Procedure:

1. In SmartPTT Radioserver Configurator, open the **Settings** tab.
2. In the left pane, click **Client Connections**.

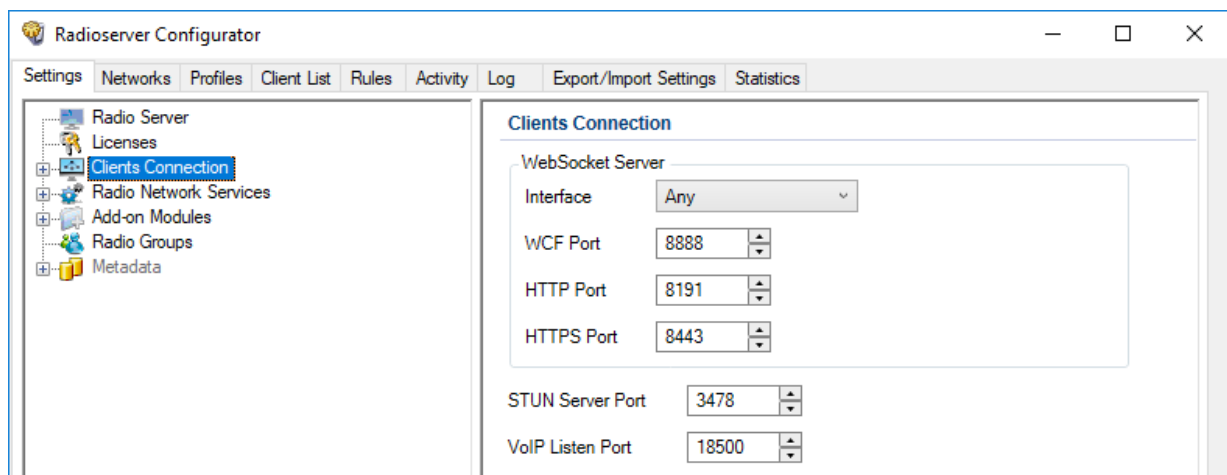



3. If required, in the right pane, from the **Interface** list, select the desired IP address:

To allow SmartPTT Radioserver to accept connection requests to any address of its own, select *Any*.

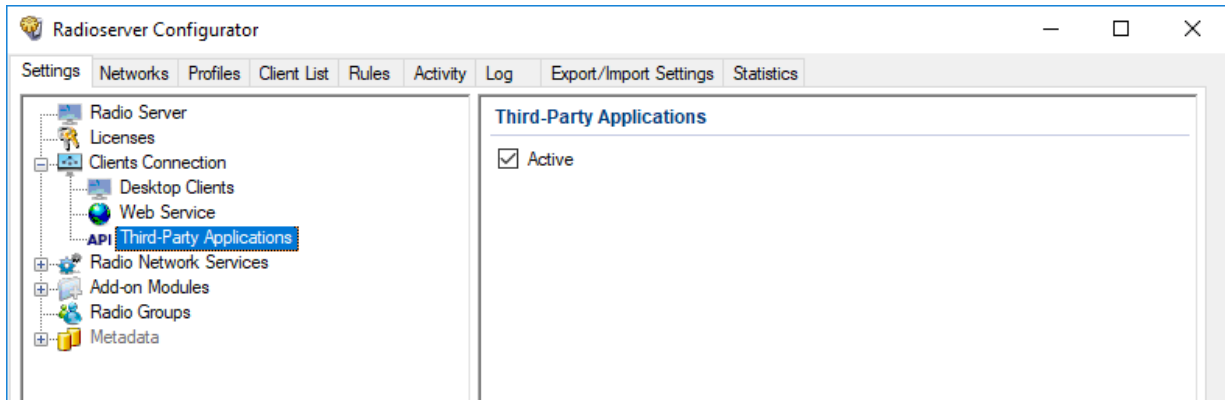

To allow third-party applications to connect to SmartPTT Radioserver only through a specific address, select the desired IP address from the list.

4. In the **HTTP Port** field, enter the desired port number for connecting to third-party applications or SmartPTT SCADA.
5. If third-party applications support voice transmission, in the **VoIP Listen Port** field, enter the UDP port number that will be used to exchange voice traffic between SmartPTT Radioserver and third-party applications.
6. In the left pane, expand the **Client Connections** node.
7. Click the **Third Party Applications** node.



8. In the right pane, select the **Active** check box.
9. To save changes, at the bottom of the SmartPTT Radioserver Configurator window, click **Save Configuration** ().

Postrequisites:

- To apply changes immediately, at the bottom of the SmartPTT Radioserver Configurator window, click **Start** () or **Restart** ().
- If required, in the firewall software, unlock the set TCP and UDP ports.
- Create accounts for authorization of third-party applications and SmartPTT SCADA on SmartPTT Radioserver. For details, see [Managing Account Parameters](#).

8.1.6 Profiles

In SmartPTT, profile is a tool for client permissions and restrictions management. Profiles control the following features:

- Radio systems access, including per-slot and per-control station access.
- Access to a limited set of radios and talkgroups.
- Access to a limited networks and features within them. For details, see [Available Networks](#).
- Access to a limited dispatcher actions. For details, see [Available Actions](#).

NOTE

In addition to profiles, client permissions and restrictions in SmartPTT Dispatcher can be adjusted on per-console basis using operator rights. For details, see "Operators" in *SmartPTT Dispatcher Guide*.

Profiles can be assigned to any type of supported clients. Before the assignment, the following details must be considered:

- Profile assignment is optional. If a client account does not have a profile, a client will have unlimited access to all radio systems, contacts, features.
- Each profile can be assigned to multiple client accounts.
- Desktop clients require profiles only if they must be authenticated by SmartPTT Radioserver.

8.1.6.1 Available Networks

Available networks and available features within them are as follows:

Available functionality	Description
Network	Allows/denies operation with the functionality of the radio network or control station.
All Call/All Call on sites	Allows/denies receiving and initiating All Calls including All Calls on sites (available for NAI-Linked Capacity Plus).
<Talkgroup name>	Allows/denies interaction with the talkgroup.

The following features are available for repeater-based systems only. They are unavailable for control stations.

Radio Network Services	<p>The subnodes of this node refer to the radio network services:</p> <ul style="list-style-type: none"> • ARS — allows/denies access to ARS service. This requires configuring ARS on SmartPTT Radioserver. For details, see Registration Service. <div data-bbox="824 1266 1511 1430" style="background-color: #ffe6e6; padding: 5px;"> <p>Important This parameter does not prohibit the registration of radios according to Heartbeats. For details, see Tallysman.</p> </div> <ul style="list-style-type: none"> • TMS — allows/denies access to TMS service. This requires configuring TMS on SmartPTT Radioserver. For details, see Text Messaging Service. • GPS — allows/denies access to GPS service. This requires configuring GPS on SmartPTT Radioserver. For details, see Location Service. <div data-bbox="824 1732 1511 1848" style="background-color: #e6e6e6; padding: 5px;"> <p>NOTE This parameter does not prohibit operation with Indoor beacon systems. For details, see Indoor Tracking.</p> </div>
-------------------------------	---

- **Telemetry** — allows/denies access to Telemetry service. This requires configuring Telemetry service on SmartPTT Radioserver. For details, see Telemetry Service.

Voice Calls

The subnodes of this node refer to the voice calls:

- **Group Calls** — allows/denies voice calls to the talkgroup.
- **Private Calls** — allows/denies initiating and receiving private calls to radios.
- **Private calls monitoring** — allows/denies remote monitor of private calls within the network including calls from one radio to another, calls from a radio to another dispatcher, calls from a radio to a telephone subscriber.

Available Networks and their Features Applicability to Different Client Types

The following network-level features are applicable to desktop clients only:

- Temporary talkgroups.
- Job tickets.
- Telemetry.

Other features are applicable to all client types.

8.1.6.2 Available Actions

For SmartPTT clients the following dispatcher actions are available:

Action	Description
Outgoing calls	Allows/denies the outgoing calls that are available within networks according to the settings on the Available Networks tab. The node contains the Maximum number of simultaneous calls node, limiting the number of simultaneous outgoing calls that the dispatcher can initiate. If selected, a specific value is set. If not selected, the number of simultaneous outgoing calls is limited by the bandwidth of the radio system. It ranges from 1 to 45. The default value is 45.
Radio Location Request	Allows/denies to request radio location data by means of single and periodic coordinate requests.

Remote Monitor	Allows/denies to use the Remote Monitor function. NOTE The Remote Monitor function requires permission to operate with private calls.
Block radio/Unblock radio	Allows/denies to block/unblock radios.
Cross-patches management	Allows/denies the dispatcher to edit those cross-patches, which include only talkgroups allowed to the dispatcher by the profile.
Bridging management	Allows/denies to configure the calls routing on SmartPTT Radioserver.
Request data from radioserver	This node has the following subnodes: <ul style="list-style-type: none"> • Event Log — allows/denies to request the SmartPTT Radioserver Event Log. • Reports and Movement reports — allows/denies to request the event history and data on the radio movement.
Monitoring	This node has the following subnodes: <ul style="list-style-type: none"> • Air monitoring — allows/denies to monitor the system in real time in SmartPTT Dispatcher. • Monitoring reports and coverage map — allows/denies to build monitoring reports and coverage maps according to monitoring data from SmartPTT Radioserver.

Available Dispatcher Actions Applicability to Different Client Types

The actions available within the network apply to different types of SmartPTT clients according to the following table:

Feature	Desktop	Web Clients	Third-Party Apps	SmartPTT Mobile
Outgoing calls	YES	YES	YES	YES
Maximum number of simultaneous calls	YES	YES	YES	YES
Radio location requests	YES	YES	YES	YES
Remote monitor	YES	NO	NO	NO

Feature	Desktop	Web Clients	Third-Party Apps	SmartPTT Mobile
Block/unblock radios	YES	YES	YES	YES
Cross patches management	YES	YES	NO	NO
Bridging management	YES	NO	NO	NO
Request data from radioserver	YES	NO	NO	NO
Event log	YES	NO	NO	NO
Reports and movement reports	YES	NO	NO	NO
Monitoring	YES	NO	NO	NO
Air monitoring	YES	NO	NO	NO
Monitoring reports and coverage map	YES	NO	NO	NO

8.1.6.3 Managing Profiles

Follow the procedure to add, make copy, delete or edit a profile.

Prerequisites:

- Determine the profile name.
- Determine radio IDs that will be available to a profile.

Procedure:

1. In SmartPTT Radioserver Configurator, open the **Profiles** tab.

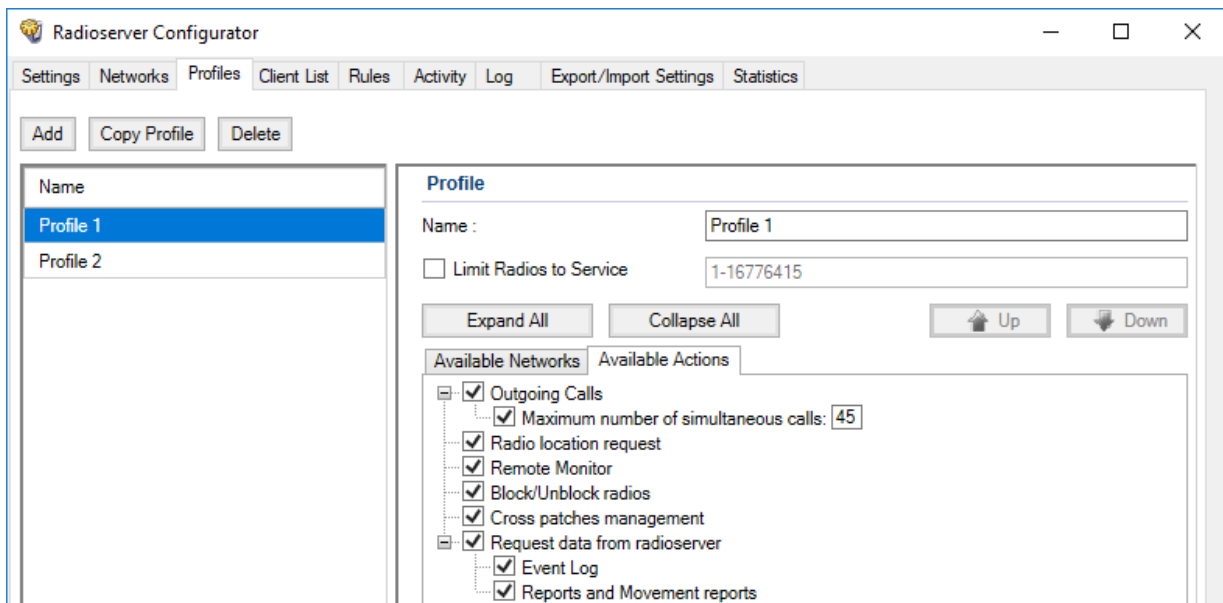

- In the left pane, perform one of the following actions:

To add a new profile,	click Add .
To copy a profile,	perform the following actions: <ol style="list-style-type: none">Select the desired profile.Click Copy Profile.
To modify an existing profile settings,	click the desired profile name.
To delete a profile,	perform the following actions: <ol style="list-style-type: none">Select the desired Profile.Click Delete.Proceed to the last step of this procedure.

- In the **Name** field, type the desired profile name.
- (Optional)* If required to limit profile access to radios, configure the radio filter:
 - Select the **Limit Radios to Service** check box.
 - In the **Allowed radio ID's** field, type the IDs of radios with which a profile can interact.
- On the **Available Networks** tab, specify networks to which profile access needs to be configured. For details, see [Configuring Available Networks](#).
- On the **Available Actions** tab, specify actions to which profile access needs to be configured within the desired network. For details, see [Configuring Available Actions](#).
- To save changes, at the bottom of the SmartPTT Radioserver Configurator window, click **Save Configuration** (). Changes will be applied without restarting SmartPTT Radioserver.

Postrequisites:

Create a new client account and assign the desired profile to it. For details, see [Managing Account Parameters](#).

8.1.6.3.1 Configuring Available Networks

Follow the procedure to configure available networks for a profile.

Prerequisites:

- Connect to radio networks. For details, see [MOTOTRBO Radio Systems](#).
- (Optional)* Configure base radioserver services. For details, see [Base Configuration](#).

Procedure:

- In SmartPTT Radioserver Configurator, open the **Profiles** tab.
- In the left pane, click the desired profile.
- In the right pane, open the **Available Networks** tab.

4. On the tab, perform one of the following actions:

To expand the desired network,

click the Expand button () next to the desired network name.

To expand all nodes,

click **Expand All**.

5. Select the check box next to the network name so that a profile can access it.

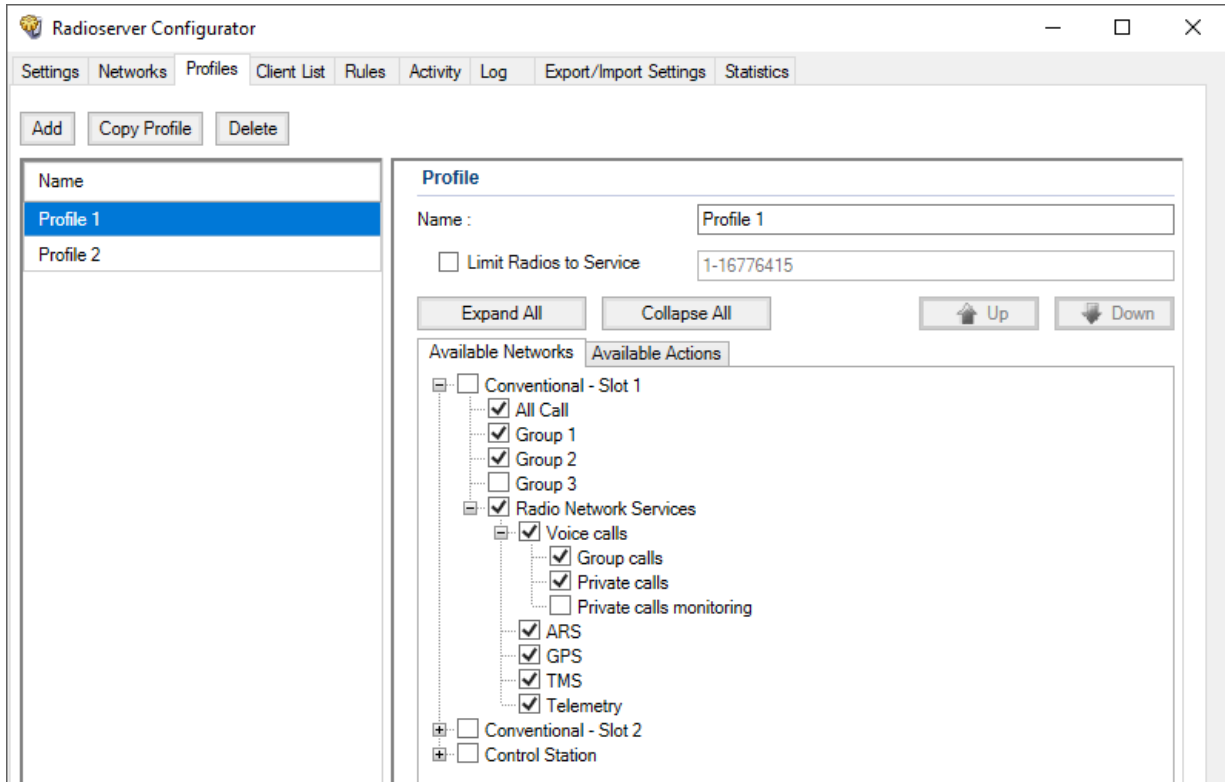

6. To limit profile functions referred to the groups, perform the following actions:

To limit access to the talkgroup,

clear the **<group name>** check box.

To limit access to the All Call feature,

clear the **All Call** check box.

7. To limit profile access to radio network services, perform the following actions:

To limit access to ARS,

clear the **ARS** check box.

To limit access to GPS,

clear the **GPS** check box.

To limit access to TMS,

clear the **TMS** check box.

To limit access to Telemetry,

clear the **Telemetry** check box.

To limit access to all radio network services,

clear the **Radio Network Services** check box.

8. To limit profile functions referred to voice calls, perform the following actions:

To limit access to group calls,	clear the Group calls check box.
To limit access to private calls,	clear the Private calls check box.
To deny to listen to calls in which the profile does not participate,	clear the Private calls monitoring check box.
To limit access to voice calls,	clear the Voice calls check box.

9. (Optional) Click **Up** or **Down** to move objects to the desired position in the network tree. For this, select the node with the network name.
10. To save changes, at the bottom of the SmartPTT Radioserver Configurator window, click **Save Configuration** (). Changes will be applied without restarting SmartPTT Radioserver.

Postrequisites:

- Configure available actions within the selected network for a profile. For details, see [Configuring Available Actions](#).
- Create the client account and assign the desired profile to it. For details, see [Managing Account Parameters](#).

8.1.6.3.2 Configuring Available Actions

Follow the procedure to configure available actions for a profile.

Prerequisites:

- Connect to radio networks. For details, see [MOTOTRBO Radio Systems](#).
- (Optional) Enable the following features:
 - Radio Network Services.
 - Bridging. For details, see [Managing Bridging](#).
 - Event Log database. For details, see [Configuring Event Log Database Connection](#).
 - Monitoring. For details, see [Configuring Monitoring Database Connection](#).
 - Configure the available networks. For details, see [Configuring Available Networks](#).

Procedure:

1. In SmartPTT Radioserver Configurator, open the **Profiles** tab.
2. In the left pane, click the desired profile.
3. In the right pane, open the **Available Actions** tab.
4. On the tab, perform one of the following actions:

To see the specified action subnodes,	click the Expand button () next to the desired action.
---------------------------------------	---

To expand all nodes,

click **Expand All**.

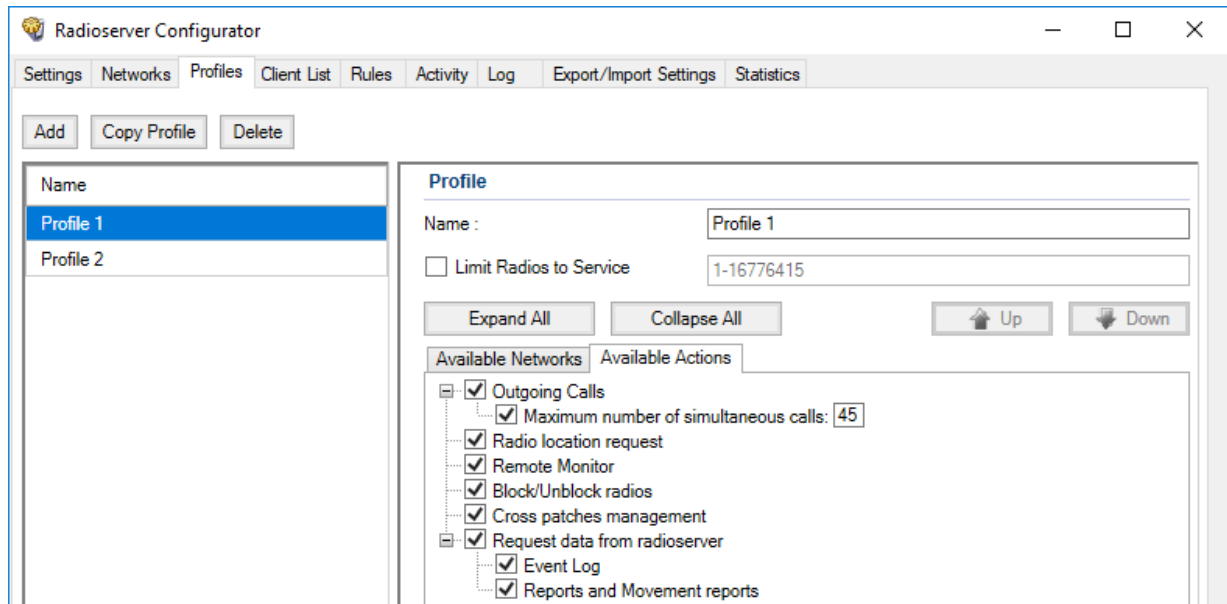

5. To limit the profile actions referred to outgoing calls, perform the following actions:

To limit outgoing calls,

clear the **Outgoing calls** check box.

To limit number of simultaneous outgoing calls that can be initiated at the same time,

perform the following actions:

1. Select the **Maximum number of simultaneous calls** check box.
2. Edit the value:
 - a. Click the default quantity.
 - b. Type the desired value.

6. To limit the profile actions referred to request data from SmartPTT Radioserver, perform the following actions:

To make unable to request data from SmartPTT Radioserver via Event Log and reports,

clear the **Request data from radioserver** check box.

To make unable to request the SmartPTT Radioserver Event Log,

clear the **Event Log** check box.

To make unable to request the event history and data on the radio movement.

clear the **Reports and Movement reports** check box.

7. To limit the profile actions referred to monitoring, perform the following actions:

To make unable to monitor the system and build monitoring reports,

clear the **Monitoring** check box.

To make unable to monitor in real time,	clear the Air monitoring check box.
To make unable to build monitoring reports and coverage maps according to monitoring data from SmartPTT Radioserver,	clear the Monitoring reports and coverage map check box.

8. To limit the profile other actions, perform the following actions:

To limit possibility to request radio location data,	clear the Radio location request check box.
To limit access to the Remote Monitor function,	clear the Remote Monitor check box.
To make unable to block/unblock radios,	clear the Block/Unblock radios check box.
To make unable to manage cross patches,	clear the Cross patches management check box.
To make unable to configure the calls routing on SmartPTT Radioserver,	clear the Bridging management check box.

9. To save changes, at the bottom of the SmartPTT Radioserver Configurator window, click **Save Configuration** (). Changes will be applied immediately, without SmartPTT Radioserver restart.

Postrequisites:

Create the client account and assign the desired profile to it. For details, see [Managing Account Parameters](#).

8.1.7 Managing Account Parameters

Follow the procedure to create a new or modify an existing client account used in SmartPTT Dispatcher, Web Client, SmartPTT Mobile, SmartPTT SCADA, or third-party application.

Prerequisites:

- Determine the name and the password for the client account.
- *(Optional)* Create and configure a profile for assigning it to the client account. For details, see [Managing Profiles](#).
- Determine the unique dispatcher identifier.

Procedure:

1. In SmartPTT Radioserver Configurator, open the **Client List** tab.
2. At the top of the **Client List** tab, click **All**.

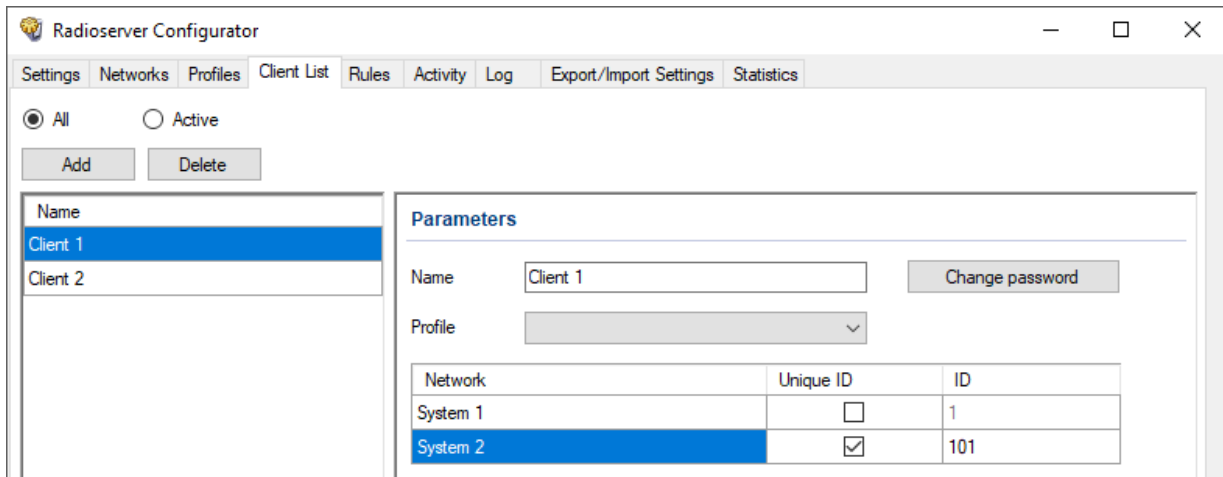

3. Perform one of the following actions:

To create a new client account, in the left pane of SmartPTT Radioserver Configurator, click **Add**.

To edit an existing client account properties, in the left pane of SmartPTT Radioserver Configurator, click the name of the desired client account.

To delete a client account, perform the following actions:

1. In the left pane of SmartPTT Radioserver Configurator, click the name of the client account you want to delete.
2. Click the **Delete** button.
3. Proceed to the last step of the procedure.

4. In the **Parameters** pane, in the **Name** field, type the user name.

5. Set the user password:

- a. Next to the **Name** field, click **Change password**.
The dialog box for entering password appears.

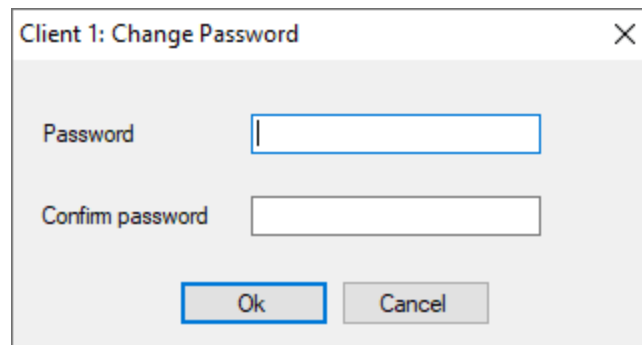

- b. In the dialog box, in the **Password** field, type the password.
- c. In the **Confirm password** field, type the password one more time.
- d. Click **Ok** to set the password and close the dialog box.

6. In the **Parameters** pane, from the **Profile** list, select the desired profile.
7. *(Optional)* In the table below, in the **Unique ID** column, set the unique dispatcher identifier:
 - a. If the dispatcher must connect to the network under a unique network identifier different from the SmartPTT Radioserver identifier, select the check box into the **Unique ID** column next to the network name.
 - b. In the **ID** column, type the identifier assigned to the dispatcher within the specified network. It must be unique within the specified network.
8. To save changes, at the bottom of the SmartPTT Radioserver Configurator window, click **Save Configuration** (). Changes will be applied without restarting SmartPTT Radioserver.

8.2 Voice Notifications

In SmartPTT, voice notifications are audio files that will be sent to one or several pre-configured talkgroups at once. They are sent by dispatchers or as a result of rules conditions fulfillment. For details, see [Rules](#).

Voice notifications are sent to radio networks as voice transmissions. They cannot be sent in radio networks where voice calls are **not** licensed or configured. Also, they cannot be sent to other VoIP system like phone systems or WAVE.

To create a voice stream, radioserver reads audio file that is available in the local or network file storage. SmartPTT does **not** copy audio files to its internal storage. If audio file is unavailable to read, or its access requires authorization, voice notification will fail.

Audio file used in voice notifications must comply with the common SmartPTT requirements to transmitted audio files. For details, see [Audio File Requirements](#).

8.2.1 Managing Voice Notifications

Follow the procedure to add a voice notification and configure its recipients.

Prerequisites:

- Configure talkgroups in the desired radio networks. For details, see [MOTOTRBO Radio Systems](#).
- Create an audio file that complies with SmartPTT requirements. For details, see [Audio File Requirements](#).

Procedure:

1. In SmartPTT Radioserver Configurator, open the **Settings** tab.
2. In the left pane, expand **Add-on Modules**, and then click **Voice Notifications**.
In the right pane, the **Active** check box appears.

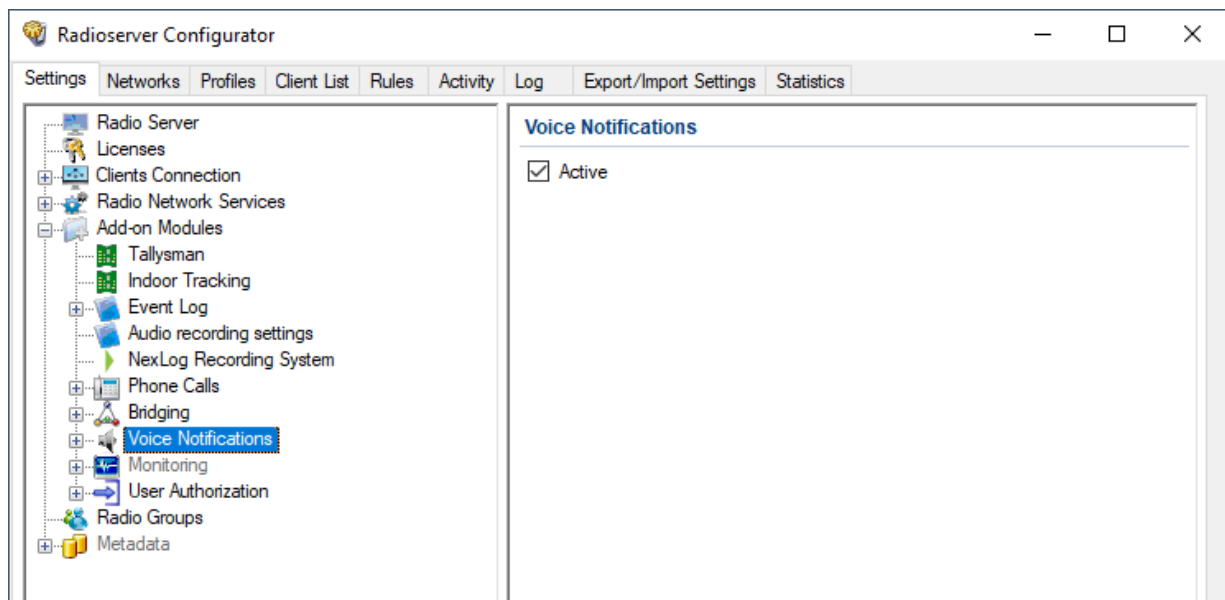

3. Select the **Active** check box.
4. Perform one of the following actions:

To add a new voice notification,

right-click the **Voice Notifications** node, and then from the actions menu, select **Add**.

To modify an existing voice notification,

expand the **Voice Notifications** node, and then select the desired voice notification.



To delete an existing voice notification,

perform the following actions:

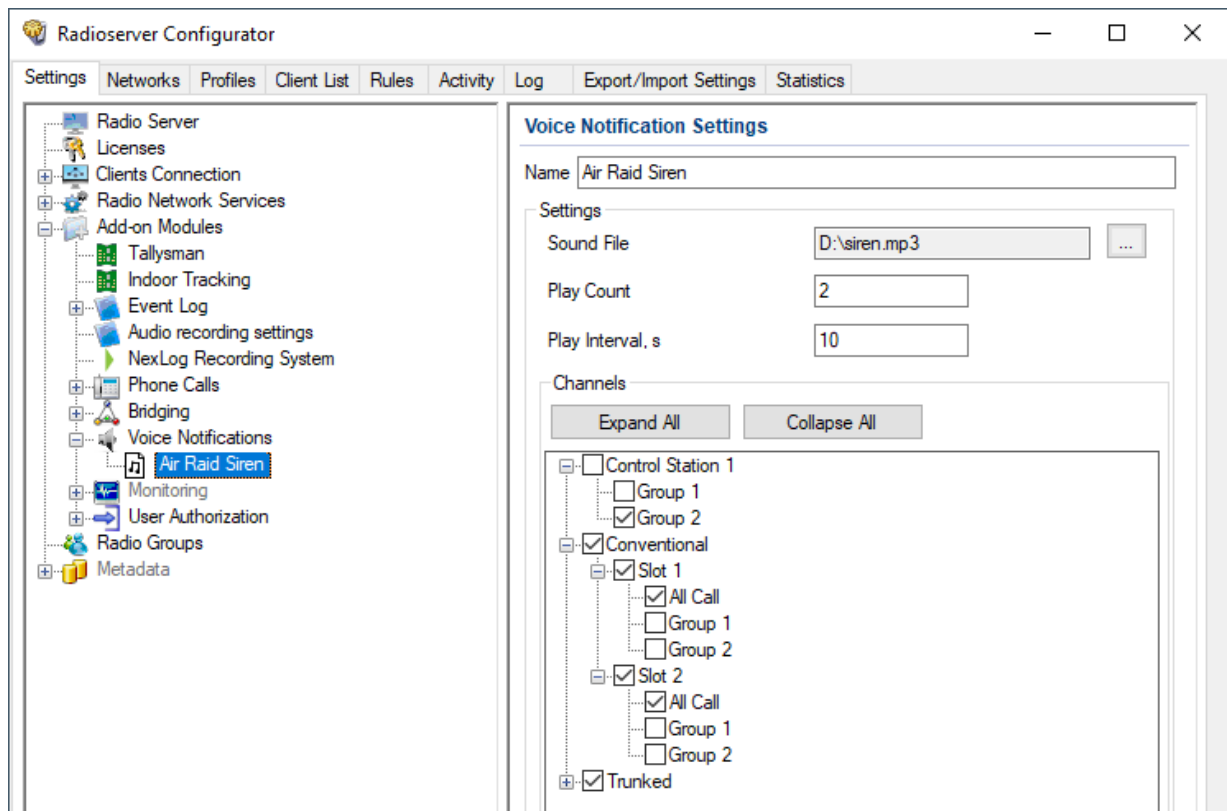
1. Expand the **Voice Notifications** node.
2. Right-click the desired voice notification, and then from the actions menu, select **Delete**.
3. Proceed to the last step of this procedure.



5. In the right pane, in the **Name** field, type the voice notification name.
6. Select the desired audio file:
 - a. To the right of the **Sound File** field, click the Browse () button.
 - b. In the dialog box that opens, select the desired file.
7. In the **Play Count** field, type the number of times the voice notification will be repeated.
8. In the **Play Interval, s** field, type the time interval between repetitions of the voice notification.
9. Configure voice notification recipients:



- a. In the **Channels** area, click **Expand All** to expand all nodes of the radio network object tree. If necessary, click Expand () or Collapse () to expand or collapse an individual node.
- b. Select the check boxes next to the desired recipients.

NOTE

Only one recipient (talkgroup or All Call) can be selected for each control station or a conventional radio system.

- c. Clear the check boxes next to the undesired recipients.
10. To save changes, at the bottom of the SmartPTT Radioserver Configurator window, click **Save Configuration** ().

Postrequisites:

To apply changes immediately, at the bottom of the SmartPTT Radioserver Configurator window, click **Start** () or **Restart** ().

8.3 Bridging

In SmartPTT, bridging is a radioserver-controlled voice-only integration feature for radios and/or talkgroups from various radio systems. Typical cases of bridging implementation are as follows:

- Voice communication between VHF and UHF radio systems.
- Radio systems integration to increase the total voice communication coverage area.
- Privileged radios integration into multiple radio systems.
- Bridging does **not** depend on dispatch consoles (active or inactive).

Bridging advances over patches for the following reasons:

- Bridging provides the ability integrate group and private calls.
- Bridging configuration rights can be provided to dispatchers.
- Bridging configuration changes do **not** require radioserver restart.

Important

Bridging does not provide text message exchange between radio systems.

Important

Bridging is unavailable for systems accessed over the 4-wire interfaces. For details, see [MOTOTRBO Control Stations](#).

In SmartPTT, bridging includes the following configuration options:

- Radioserver-defined multigroups. For details, see [Multigroups](#).
- Dispatcher-controlled routes. For details, see “Bridging” in *SmartPTT Dispatcher Guide*.

8.3.1 Multigroups

Multigroup is a SmartPTT wrapping over talkgroup that is provided within the Bridging feature. If radioserver receives a group call and the talkgroup ID is equal to the multigroup ID, radioserver will initiate a group call to the same ID in other radio systems.

To initiate a call in other radio systems, the following conditions must be fulfilled:

- Multigroup settings provide a list of control stations, conventional system slots, and trunked radio systems where the call must be initiated.
- Corresponding control stations, slots, and trunked radio systems must have the corresponding talkgroup.
- If talkgroups are unavailable, at least one radio from the list of radios must be registered on the corresponding control station, slot, or trunked radio system.

The following table provides the summary of the multigroup features:

Target System is Selected	Talkgroup is Available	Radio is Registered	Result
NO	any	any	call is not initiated
YES	NO	NO	call is not initiated
YES	YES	YES	call initiation succeeded
YES	YES	NO	call initiation succeeded
YES	YES	YES	call initiation succeeded

8.3.2 Managing Bridging

Follow the procedure to enable or disable bridging in SmartPTT.

Prerequisites:

Ensure that the installed license includes the bridging feature. For details, see [Viewing License Items](#).

Procedure:

1. In SmartPTT Radioserver Configurator, open the **Settings** tab.
2. In the left pane, expand **Add-on Modules**, and then click **Bridging**.

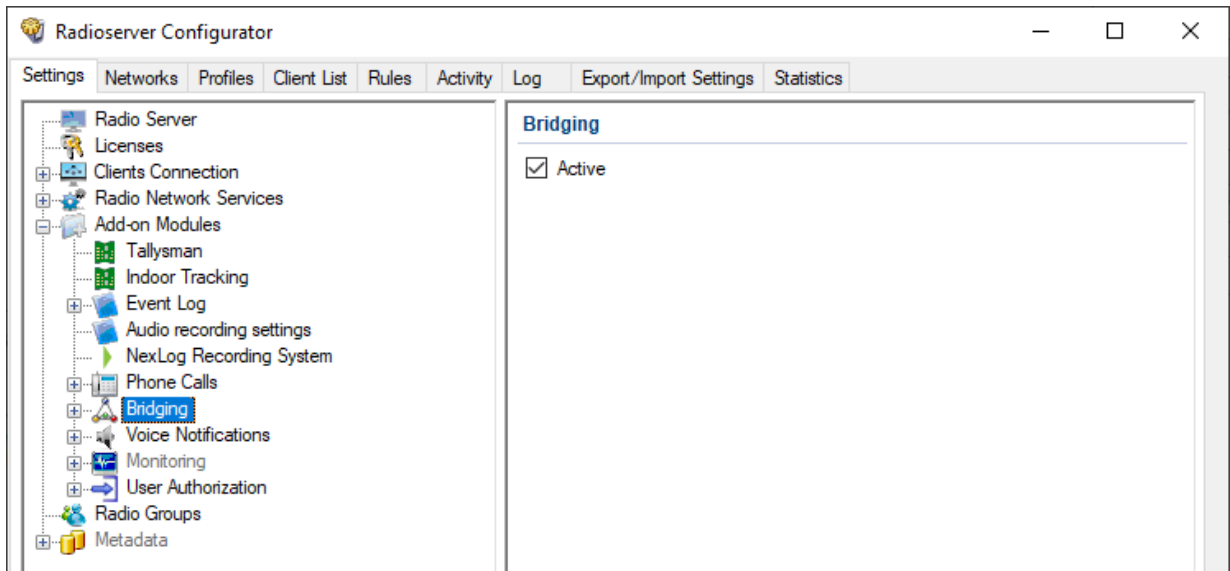



3. In the right pane, perform one of the following actions:

To enable bridging, select the **Active** check box.

To disable bridging, clear the **Active** check box.

4. To save changes, at the bottom of the SmartPTT Radioserver Configurator window, click **Save Configuration** ().

Postrequisites:

- To apply changes immediately, at the bottom of the SmartPTT Radioserver Configurator window, click **Start** () or **Restart** ().
- Configure bridging in dispatch consoles. For details, see “Bridging Service” in *SmartPTT Dispatcher Guide*.
- Add and configure multigroups. For details, see [Managing Multigroups](#).

8.3.3 Managing Multigroups

Follow the procedure to modify the list of multigroups supported by SmartPTT Radioserver.

Prerequisites:

Enable bridging. For details, see [Managing Bridging](#).

Procedure:

1. In SmartPTT Radioserver Configurator, open the **Settings** tab.
2. In the left pane, expand **Add-on Modules** → **Bridging**, and then click **Multigroups**.

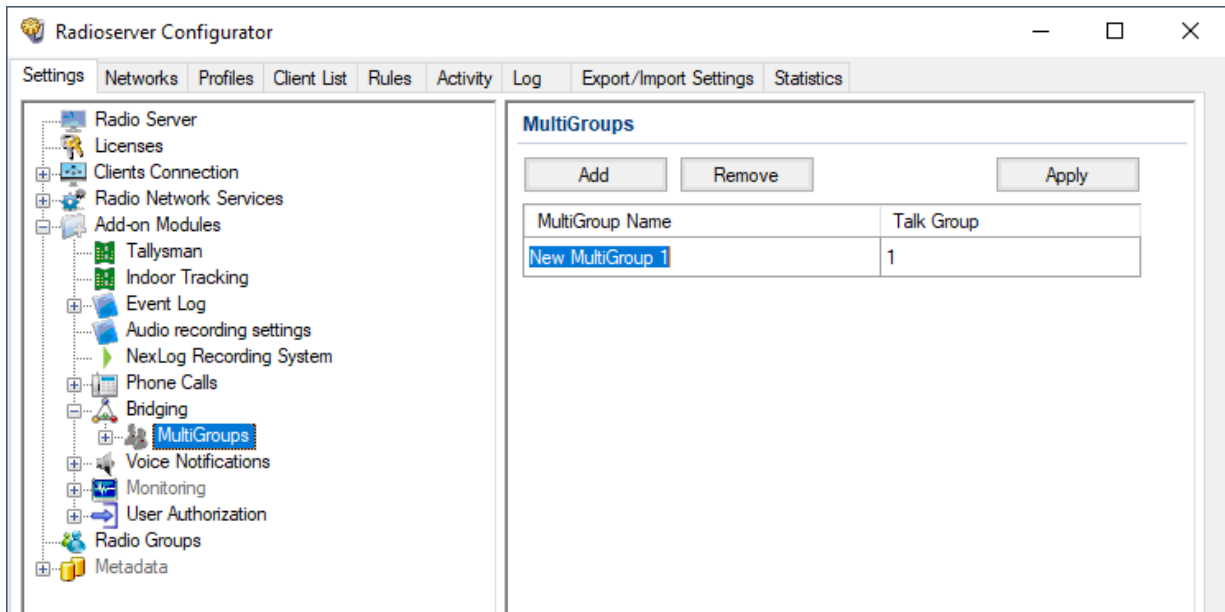

3. In the right pane, perform one of the following actions:

To add a new multigroup,

perform the following actions:

1. Click **Add**.
2. Proceed to [step 4](#).

To delete an existing multigroup,

perform the following actions:

1. Click the desired multigroup in the table.
2. Click **Remove**.

4. (Optional) Modify the parameters of the desired multigroup in the table:

- a. In the **MultiGroup Name** column, click twice the multigroup name, and then type a new name.
- b. In the **Talk Group** column, click twice the current ID, and then type a new ID.

5. (Optional) Configure the multigroups. For details, see [Configuring Multigroups](#).

6. To immediately apply changes, click **Apply**.

7. To save changes, at the bottom of the SmartPTT Radioserver Configurator window, click **Save Configuration** ().

8.3.4 Configuring Multigroups

Follow the procedure to configure an existing multigroup.

Prerequisites:

- Connect to radio networks. For details, see [MOTOTRBO Radio Systems](#).
- Add multigroups. For details, see [Managing Multigroups](#).

Procedure:

1. In SmartPTT Radioserver Configurator, open the **Settings** tab.
2. In the left pane, expand **Add-on Modules** → **Bridging** → **MultiGroups**, and then click the desired multigroup.

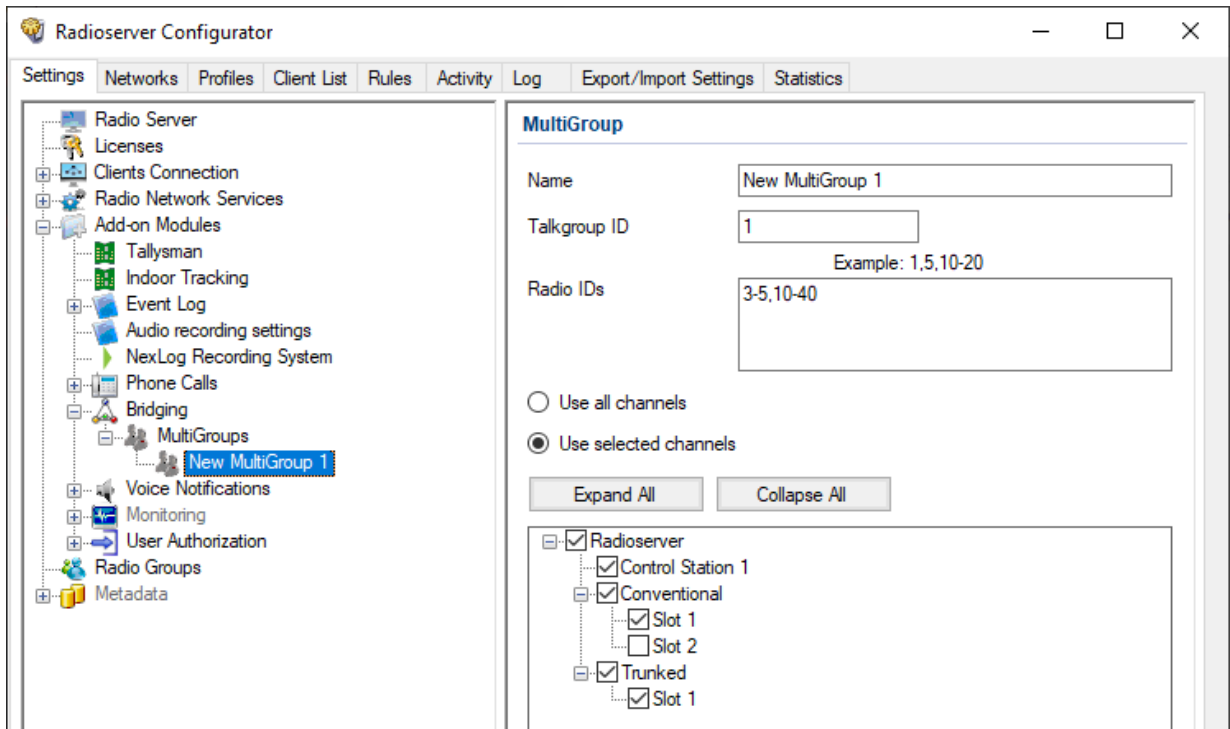

3. In the **Name** field, type the desired name for the multigroup.
4. In the **Talkgroup ID** field, type the talkgroup ID, calls to which will be interpreted by SmartPTT Radioserver as calls to the multigroup.
5. In the **Radio IDs** field, type the IDs of radios, whose registration in a radio system is required for calls to the multigroup to be bridged to that system.

6. Select bridging mode:

To bridge calls to any radio network if at least one radio listed in the **Radio IDs** field is registered there,

select the **Use all channels** option.

To bridge calls only to a limited set of radio networks,

perform the following actions:

1. Select the **Use selected channels** option.
2. Click **Expand All** to expand all nodes of the radio system object tree.
3. Select the check boxes next to the desired control stations, channels and systems.
4. Clear the check boxes next to the undesired control stations, channels and systems.

7. To save changes, at the bottom of the SmartPTT Radioserver Configurator window, click **Save Configuration** ().
8. To immediately apply changes, perform the following actions:
 - a. In the left pane, click **MultiGroups**.
 - b. In the right pane, click **Apply**.

8.4 Rules

Rules are the automatic SmartPTT reaction on events occurred in the radio system. For example, SmartPTT may react on the following events:

- Emergency alarm or call.
- Text message with a specific content.
- Dispatch console (desktop client) disconnection from radioserver.

For information on the full list of events, see [Rule Conditions](#).

When event is detected, radioserver is able to perform one or several actions:

- Send an audio file to the radio network.
- Send a group or a private text message.
- Send a voice notification. For details, see [Voice Notifications](#).

Radioserver actions may trigger other rules.

NOTE

SmartPTT Dispatcher provides additional rules to its users. For details, see “Rules” and “Lone Worker” in *SmartPTT Dispatcher Guide*.

8.4.1 Rule Conditions

Rule conditions are set of logical expressions that consist of the following elements:

- Attribute (for example, “event type”).
- Operator (for example, “equal to”).
- Value (for example, “call”).

Each rule may have several expressions. For example, in may consist of the “incoming call” and “incoming text message” expressions. To trigger a rule, all attributes must match the event.

SmartPTT does **not** prevent users from invalid conditions configuration. For example, it does **not** prevent users from configuring the “outgoing ARS” condition.

8.4.1.1 Condition Attributes

Condition attributes are as follows:

Attribute	Description
Direction	Shows if dispatch subsystem receives (incoming event) or transmits (outgoing event) to the radio network.
Event Type	One or multiple event types. For details, see Event Types below.
Date	Calendar date or date range when an event must occur.
Additional Info	Miscellaneous information that is related to the transmission (for example, text message fragment or target ID).
Control station	Name of the control station, IP Site Connect slot, or trunked system.
Talkgroup	Name of the talkgroup that receives voice call or text message.
Radio	ID of a radio that receives or initiates a transmission.
User	Radio user name. Applicable to radio systems accessible over NAI and for Capacity Max. For details, see Radio Users .
Status	Result of various transmissions. For details, see Statuses below.
Duration	Voice call duration.
SCADA Point	Name of the SCADA Point which alarm must trigger a rule. SCADA Points are available only after SmartPTT SCADA is connected to the radioserver.
Alarm	Name of the SCADA Point parameter which alarm must trigger a rule. Parameters are available only after SmartPTT SCADA is connected to the radioserver.

Event Types

In the **Event Type** list, the following options are available:

- ARS — radio registration/de-registration. For details, see [Registration of Radios](#).
- Call — group or private voice call (including Emergency Call) or voice notification or the Remote Monitor voice.
- Message — text message and/or job ticket.
- Telemetry — telemetry information and/or remote control command.
- Alarm — incoming emergency alarm.
- Block — Block Radio or Unblock Radio command. For details, see [Configuring Radioserver](#).
- User Authorization — radio user signs in or signs out from the radio.

Statuses

In the **Status** list, the following options are available:

- Monitoring — the Remote Monitor command is sent.
- Phone Call — voice call to/from the phone network.
- Radio is Available — one of the Radio Check command result.
- Sign in — radio user signs in to the radio (authorizes in it).
- Sign out — radio user signs out from the radio.

Meaning of other attribute values is the same as their names.

8.4.1.2 Condition Operators

For each attribute, the following operators are available:

Attribute	Equal to	Not equal to	Between	Contains
Direction	YES			
Event Type	YES	YES		
Date			YES	
Additional Info	YES			YES
Control station	YES			YES
Talkgroup	YES			YES
Radio	YES	YES		

Attribute	Equal to	Not equal to	Between	Contains
User	YES	YES		
Status	YES	YES		
Duration	YES	YES	YES	
SCADA Point	YES	YES		
Alarm	YES	YES		

The following operators are available for the Duration attribute only:

- Greater than.
- Greater than or equal to.
- Less than.
- Less that or equal to.

8.4.2 Adding or Modifying Rules for Radios

Follow the procedure to add a new rule for events on radios or modify an existing one.

Prerequisites:

- Create a list of events that must be affected by rules. Include the initiator and target information in the list of events.
- Connect to radio networks. For details, see [MOTOTRBO Radio Systems](#).
- *(Optional)* Ensure that audio files comply with their requirements. For details, see [Audio File Requirements](#).
- *(Optional)* Create and configure voice notifications. For details, see [Managing Voice Notifications](#).

Procedure:

1. In SmartPTT Radioserver Configurator, select the **Rules** tab.
2. On the **Rules** tab, select the **Events on radios** option.
3. Perform one of the following actions:

To add a new rule,

click **Add (+)** at the top of the window.

To modify an existing rule,

select the desired rule in the rule table, and then click **Modify (✎)**.

The **Rule** window appears.

Rule
— □ ×

Name:

Active:

Conditions

Direction: Equal to Incoming

Event Type: Equal to Alarm

Date:

Additional Information:

Control Station:

Talkgroup:

Radio: Equal to 417 0 0

User:

Status:

Duration:

SCADA object:

SCADA Alarm:

Actions

Play Sound:

Send Message:

Example: 1-99, 150

Radios

User

Talkgroup

Send Message To Initiator



Start Voice Notification:

Stop Current Voice Notification:

4. In the **Name** field, type the rule name.
5. *(Optional)* Select the **Active** check box to create an active rule.
6. In the **Conditions** area, perform the following actions:
 - a. Select the check box that is related to the desired condition attribute. For details, see [Rule Conditions](#).
 - b. From the list next to the check box, select the desired dispatcher.

- c. In the fields and/or from the lists placed next to the dispatcher, select the desired condition values.
7. Repeat [step 6](#) for all the desired conditions.
8. In the **Actions** area, configure the actions that will be taken when the rule is triggered. For details, see [Configuring Actions](#).
9. Click **Save** at the bottom of the **Rule** window to apply changes and close the window. The configured rule appears in the rules table.
10. To save changes, at the bottom of the SmartPTT Radioserver Configurator window, click **Save Configuration** ().

Postrequisites:

To apply changes immediately, at the bottom of the SmartPTT Radioserver Configurator window, click **Start** () or **Restart** ().

8.4.2.1 Configuring Actions

Follow the procedure to configure the actions that will be taken when the rule is triggered.

Prerequisites:

- Start the rule configuration.
- Ensure that the desired voice notification is created and configured. For details, see [Managing Voice Notifications](#).
- If an audio must be sent to the initiator, create an audio file that complies with the general audio file requirements. For details, see [Audio File Requirements](#)

8.4.3 Adding or Modifying Rules for Dispatcher

Follow the procedure to add a new or edit an existing rule that is related to the SmartPTT Dispatcher connection status. The rule is **not** applicable to other types of clients.

Important

Created rule will be applied to all SmartPTT Dispatcher applications.

Prerequisites:

- *(Optional)* Ensure that audio files comply with their requirements. For details, see [Audio File Requirements](#)

8.4.4 Managing Rules

Follow the procedure to activate/deactivate or delete an existing rule.

Procedure:

1. In SmartPTT Radioserver Configurator, open the **Rules** tab.

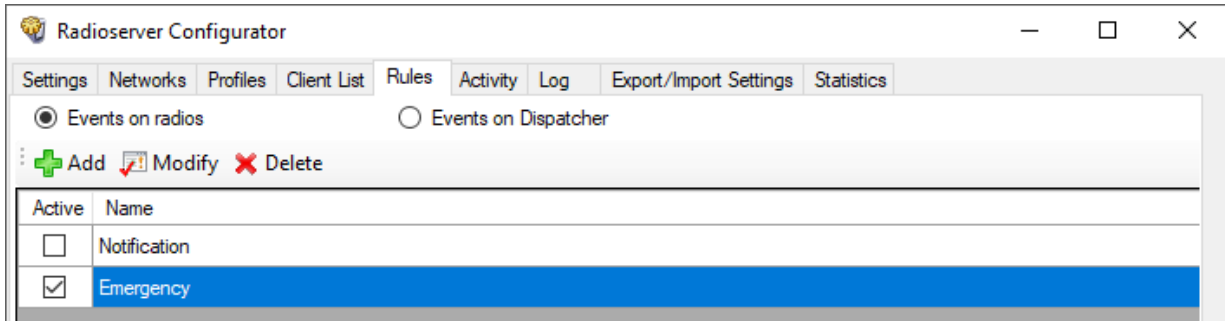

2. Show the desired rules:

To show rules related to events in the radio network,

click **Event on radios**.

To show rules related to the dispatch console disconnection and/or connection,

click **Events on Dispatcher**.

3. Click the desired rule.
4. Perform one of the following actions:

To activate the desired rule,

perform the following actions:

1. Click **Modify** () at the top of the window. The **Rule** window opens.
2. Select the **Active** check box.
3. At the bottom of the window, click **Save**.

To deactivate the desired rule,

perform the following actions:

1. Click **Modify** () at the top of the window. The **Rule** window opens.
2. Select the **Active** check box.
3. At the bottom of the window, click **Save**.

To delete a rule,

in the top part of the **Rules** tab, click **Delete** (), and then confirm the deletion.

5. To save changes, at the bottom of the SmartPTT Radioserver Configurator window, click **Save Configuration** ().

Postrequisites:

To apply changes immediately, at the bottom of the SmartPTT Radioserver Configurator window, click **Start** (▶) or **Restart** (◀▶).

8.5 Network Monitoring

In SmartPTT, network monitoring is a process of the information gathering about wireline network devices performance. Information gathering is performed by the radioserver over the Simple Network Management Protocol (SNMP). Data are saved to the dedicated database.

Important

Network monitoring is unavailable for Capacity Max.

When the monitoring is active, dispatch console receives the following capabilities:

- Network topology visualization.
- Network devices control.
- Information on device alarms.
- Monitoring reports generation.

SmartPTT gathers information for the following devices:

- Radioserver host.
- Repeaters.
- Routers and switches.
- Uninterruptible power supplies (UPS).
- Supermicro server platforms.
- Generic network devices (for example, dispatch console hosts).

All the devices can be grouped into Locations, a logical elements that can be associated with a site or a dispatch center.

NOTE

In Connect Plus, the Location element is created automatically per each XRC controller and, therefore, is associated with a system site.

8.5.1 External SNMP Services

SmartPTT provides integration with a third-party SNMP services. Radioserver connects to those services as a client application and provides information about all of the monitored devices.

To support SmartPTT connection, SNMP services must have specific MIB files uploaded to it. MIB files are the management information base files that define a device parameters and its attributes. If you need more information on MIB files utilization for your SNMP, submit a request to [SmartPTT Technical Support Center](#).

MIB files that define radioserver as a network device, are available in the `.\MIB` directory of the radioserver installation directory.

8.5.1.1 Configuring SNMP Server Connection

Follow the procedure to configure SNMP server connection.

Prerequisites:

- Ensure that SmartPTT license allows SNMP connection. For details, see [Viewing License Items](#).
- Configure SmartPTT connection to the monitoring database. For details, see [Configuring Monitoring Database Connection](#).

Procedure:

1. In SmartPTT Radioserver Configurator, open the **Settings** tab.
2. In the left pane, expand **Add-on Modules** → **Monitoring**, and then click **SNMP Service**.
The SNMP service settings appear in the right pane.

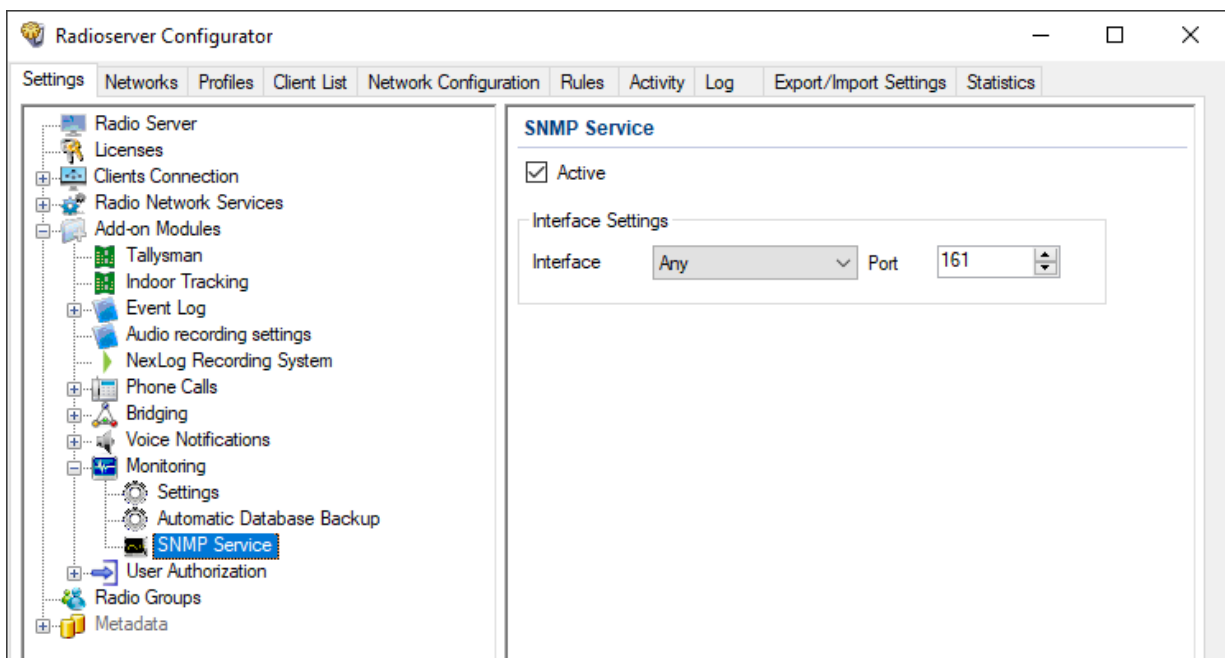

3. Select the **Active** check box.

Important

Do not change **Interface Settings** without need.

4. If necessary, change **Interface Settings**:
 - a. In the **Interface** list, select the SmartPTT Radioserver IP address to which the SNMP server will connect.
 - b. In the **Port** field, enter the port number for listening to requests from the SNMP server.
5. To save changes, at the bottom of the SmartPTT Radioserver Configurator window, click **Save Configuration** ().

Postrequisites:

- To apply changes immediately, at the bottom of the SmartPTT Radioserver Configurator window, click **Start** () or **Restart** ().

- Configure external SNMP monitoring for SmartPTT Radioserver. For details, see [Configuring SNMP for Radioserver](#).
- Configure external SNMP monitoring for radio network devices.
- Install the SNMP server and configure it, specifying the SmartPTT Radioserver IP address.
- In the SNMP server, install the MIB files located in the following folder: <SmartPTT installation path>\Server\MIB.
- Configure the desired devices in the SNMP server.

8.5.2 Configuring SNMP for Radioserver

Follow the procedure to configure the SNMP monitoring of the SmartPTT Radioserver host as a separate network device that is not part of the radio network.

Prerequisites:

- Configure SmartPTT connection to the monitoring database. For details, see [Configuring Monitoring Database Connection](#).
- Configure SmartPTT interface for an external SNMP server. For details, see [Configuring SNMP Server Connection](#).
- Obtain the community string for the SNMP server.

Procedure:

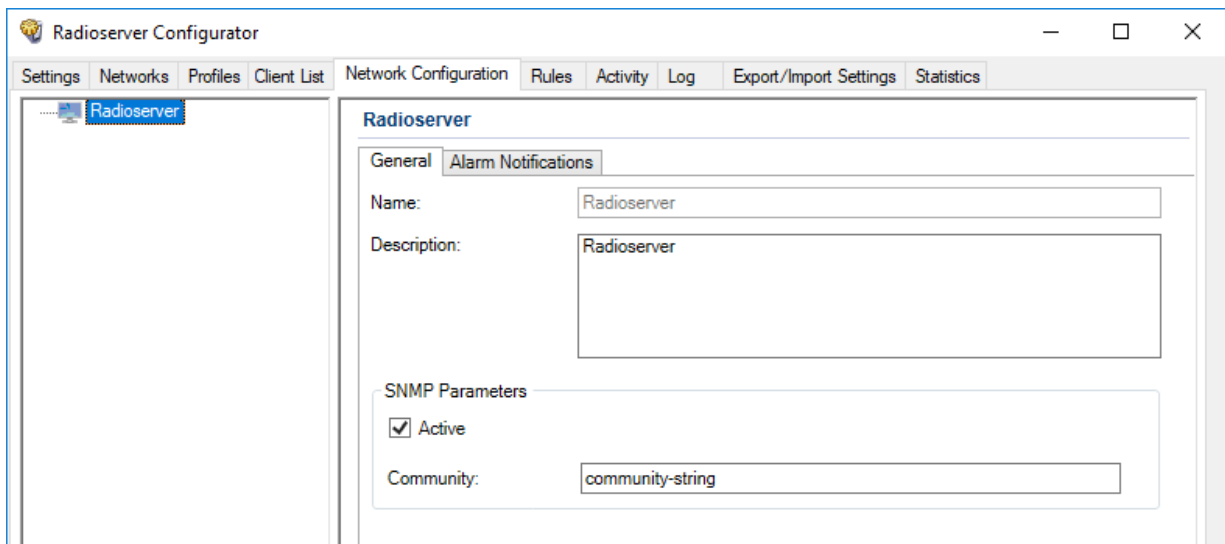

1. In SmartPTT Radioserver Configurator, open the **Network Configuration** tab.
2. In the left pane of the **Network Configuration** tab, click <Radioserver name>.



3. In the right pane of the **Network Configuration** tab, open the **General** tab.
4. (Optional) In the tab, in the **Description** field, type the information about a radioserver.
5. In the **SNMP Parameters** area, select the **Active** check box.
6. In the **Community** field, type the community string of the SNMP server.

- To save changes, at the bottom of the SmartPTT Radioserver Configurator window, click **Save Configuration** ().

Postrequisites:

- Configure alarm notifications. For details, see [Configuring Alarm Notifications](#).
- In the SNMP server settings, assign the read-only attribute to the community entry.
- To apply changes immediately, at the bottom of the SmartPTT Radioserver Configurator window, click **Start** () or **Restart** ().

8.5.3 Configuring Radioserver Monitoring in the Network

Follow the procedure to configure the radioserver monitoring as a virtual network device.

Prerequisites:

- Connect a radioserver to the desired radio systems. For details, see [MOTOTRBO Radio Systems](#).
- Configure SmartPTT connection to the monitoring database. For details, see [Configuring Monitoring Database Connection](#).
- Configure SmartPTT interface for an external SNMP server. For details, see [Configuring SNMP Server Connection](#).
- Obtain the community string for the SNMP server.

Procedure:

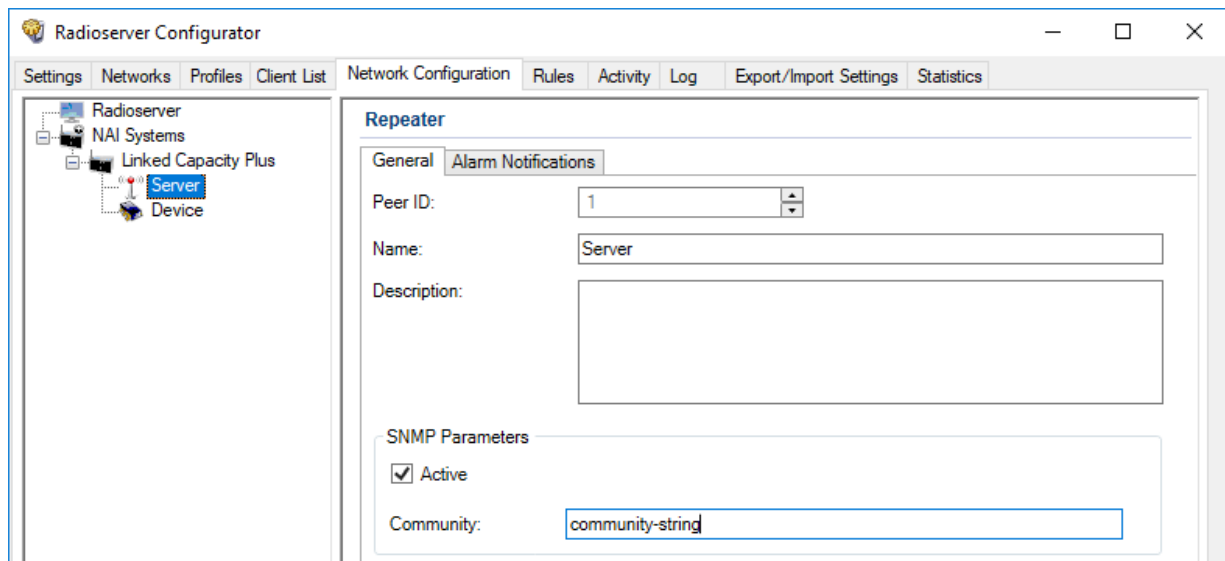

- In SmartPTT Radioserver Configurator, open the **Network Configuration** tab.
- In the left pane of the **Network Configuration** tab, expand <network type> → <network name>. If the element corresponding to a radioserver misses, expand the <location name> node, and then click the node that corresponds to the radioserver element.



- In the right pane of the **Network Configuration** tab, in the **Name** field, type the name of a radioserver.
- In the **Description** field, type the short information about a radioserver.

5. In the **SNMP Parameters** area, select the **Active** check box.
6. In the **Community** field, type the community entry used for authentication on the SNMP server.
7. To save changes, at the bottom of the SmartPTT Radioserver Configurator window, click **Save Configuration** ().

Postrequisites:

- Configure alarm notifications. For details, see [Configuring Alarm Notifications](#).
- To apply changes immediately, at the bottom of the SmartPTT Radioserver Configurator window, click **Start** () or **Restart** ().

8.5.4 Adding and Configuring Repeaters

Follow the procedure to add or configure the repeater monitoring settings.

Prerequisites:

- Connect a radioserver to the desired radio systems. For details, see [MOTOTRBO Radio Systems](#).
- Configure SmartPTT connection to the monitoring database. For details, see [Configuring Monitoring Database Connection](#).
- Configure SmartPTT interface for an external SNMP server. For details, see [Configuring SNMP Server Connection](#).
- Obtain the community string for the SNMP server.

Procedure:

1. In SmartPTT Radioserver Configurator, open the **Network Configuration** tab.
2. In the left pane of the **Network Configuration** tab, expand **<network type>** → **<network name>**.
3. Perform one of the following actions:

To add a new repeater,

right-click the network name, and then (from the actions menu) select **Add Repeater**.

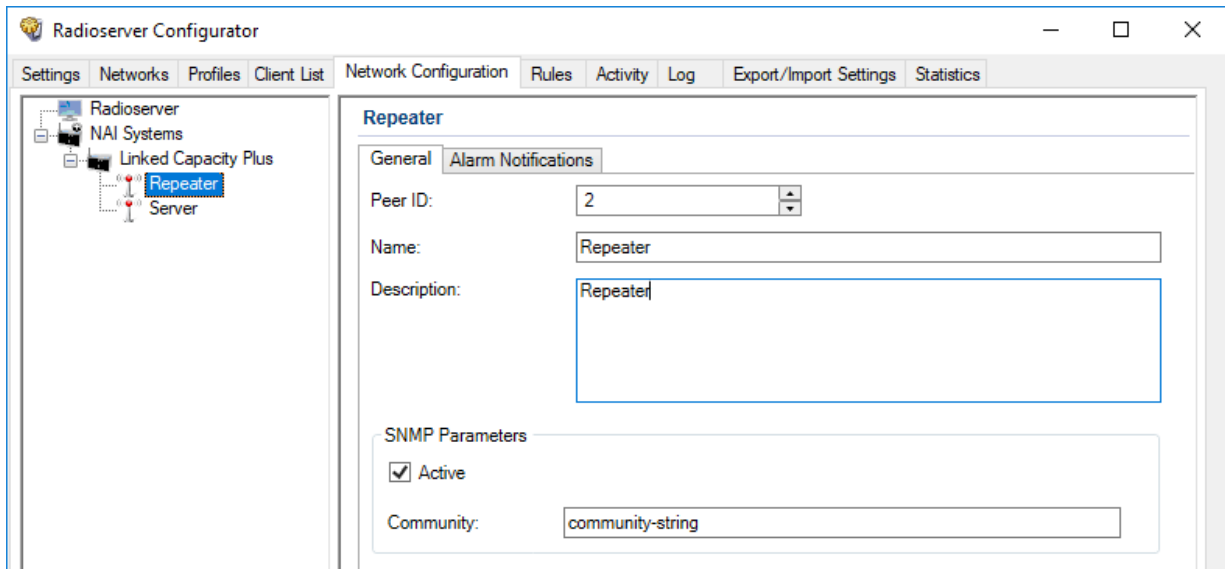

To edit repeater parameters,

click the desired repeater. If the desired element misses, expand the **<location name>** node, and then click the element corresponding to a repeater.



4. In the right pane of the **Network Configuration** tab, open the **General** tab.
5. In the **General** tab, perform the following actions:
6. In the **Peer ID** field, enter a unique identifier of a repeater.
7. In the **Name** field, type any repeater name.
8. *(Optional)* In the **Description** field, type the repeater description that appears on a topology diagram in SmartPTT Dispatcher.
9. In the **SNMP Parameters** area, select the **Active** check box.
10. In the field **Community**, type the community entry of the SNMP server.
11. To save changes, at the bottom of the SmartPTT Radioserver Configurator window, click **Save Configuration** ().

Postrequisites:

- Configure alarm notifications. For details, see [Configuring Alarm Notifications](#).
- Update the topology. For details, see [Updating Topology](#).
- To delete a repeater, in the left pane of the tab, right-click the repeater name and select **Remove Repeater**.
- To apply changes immediately, at the bottom of the SmartPTT Radioserver Configurator window, click **Start** () or **Restart** ().

8.5.5 Adding and Configuring Devices

Follow the procedure to add and configure the device monitoring settings.

Prerequisites:

- Connect to radio networks. For details, see [MOTOTRBO Radio Systems](#).
- Configure SmartPTT connection to the monitoring database. For details, see [Configuring Monitoring Database Connection](#).

- Configure SmartPTT interface for an external SNMP server. For details, see [Configuring SNMP Server Connection](#).
- Obtain the community string for the SNMP server.

Procedure:

1. In SmartPTT Radioserver Configurator, open the **Network Configuration** tab.
2. In the left pane of the **Network Configuration** tab, perform one of the following actions:

To access devices operating with control stations, expand **Control Stations**.

To access devices of repeater systems, expand **<network type>** → **<network name>**

3. Perform one of the following actions:

To add a new device, right-click the network name or the **Control Stations** node, and then from the actions menu select **Add Device**.



To edit device parameters, click the desired device. If the desired element misses, expand the **<location name>** node, and then click the element corresponding to a device.

The screenshot shows the Radioserver Configurator interface. The 'Network Configuration' tab is active. The left pane shows a tree view with 'RadioServer', 'NAI Systems', 'Linked Capacity Plus', 'Server', and 'Device'. The 'Device' configuration form is displayed, with the following fields and values:

- Device type: Unknown (dropdown)
- Name: Device (text box)
- Description: (empty text box)
- Interface: Any (dropdown)
- Port 162: (spin box)
- IP address: 0.0.0.0 (text box)
- Port 161: (spin box)
- SNMP Version: V1 (dropdown)
- Community: ? (text box)
- Response Timeout, s: 3 (text box)
- Polling Interval, s: 30 (text box)
- Check Connection: (button)
- SNMP Parameters:
 - Active:
 - Community: community-string (text box)

4. In the right pane of the tab, open the **General** tab.
5. In the **General** tab, from the **Type** list, select the desired device type.
6. In the **Name** field, type the device name.
7. *(Optional)* In the **Description** field, type the device description that appears on a topology diagram in SmartPTT Dispatcher.
8. Configure connection to a device:
 - a. From the **Interface** list, select the IP address of the SmartPTT Radioserver host for interacting with a device.
 - b. In the **Port** field, enter the port number that a server will use for interacting with a device.
 - c. In the **IP-address** field, type the IP address of a device.
 - d. In the **Port** field, enter the device port number.
9. From the **SNMP Version** list, select the desired version of the SNMP protocol.
10. In the **Community** field, type the community name that is used for connection to a radio gateway over the SNMP protocol in the local network.
11. In the **Response Timeout, s** field, type the amount of time in seconds during which a radioserver expects a response from a device.
12. In the **Polling Interval, s** field, type the amount of time in seconds after which a radioserver sends a request to a device.
13. Click the **Check Connection** button to check the status of the radio gateway connection. A new window with information on the connection status appears.
14. To save changes, at the bottom of the SmartPTT Radioserver Configurator window, click **Save Configuration** ().

Postrequisites:

- Configure alarm notifications. For details, see [Configuring Alarm Notifications](#).
- Update the topology. For details, see [Updating Topology](#).
- To delete a device, in the left pane of the tab, right-click the device name and select **Remove Device**.
- To apply changes immediately, at the bottom of the SmartPTT Radioserver Configurator window, click **Start** () or **Restart** ().

8.5.6 Adding and Configuring Locations

Follow the procedure to add or configure location settings in the network configuration.

Prerequisites:

- Connect to radio networks. For details, see [MOTOTRBO Radio Systems](#).
- Configure SmartPTT connection to the monitoring database. For details, see [Configuring Monitoring Database Connection](#).

- Add the repeaters and devices to the network configuration:
 - To add a repeater, see [Adding and Configuring Repeaters](#).
 - To add a device, see [Adding and Configuring Devices](#).

Procedure:

1. In SmartPTT Radioserver Configurator, open the **Network Configuration** tab.
2. In the **Network Configuration** tab, perform one of the following actions:

To access locations connected to control stations, expand **Control Stations**.

To access locations of repeater systems, expand **<network type>** → **<network name>**

3. Perform one of the following actions:

To add a new location, right-click the network name, and then from the actions menu select **Add Location**.

To edit location parameters, click the desired location.

Important

Location adding is not available for Connect Plus systems.

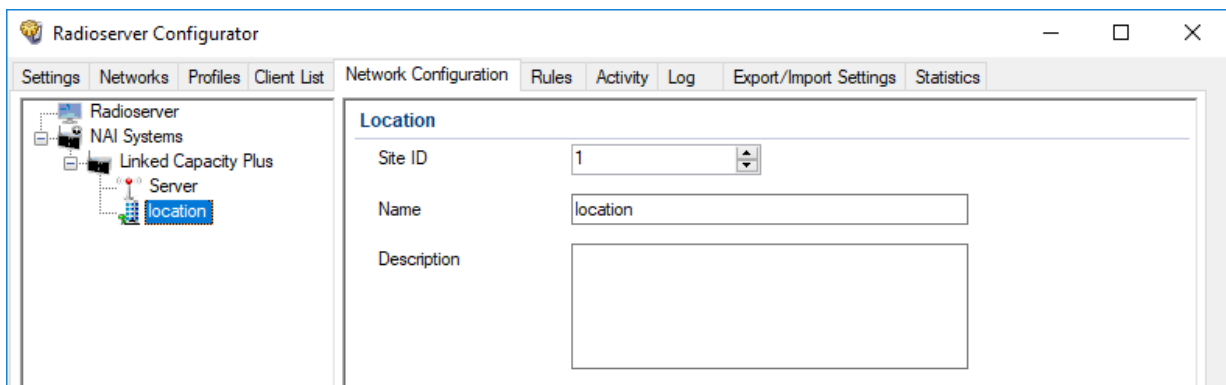

4. In the right part of the tab, in the field **Site ID** (if available), type the site number.
5. In the right pane of the tab, in the **Name** field (if available), type the desired location name.
6. (Optional) In the **Description** field, type the location description.
7. Specify elements that should be grouped in this location:

To add an element to the location, drag the desired element to the location.

To move an element from one location to another, perform the following actions:

1. Expand the node corresponding to the location from which you want to move an element.
 2. Expand the node corresponding to the location where you want to move an element.
-

3. Drag the desired element to the desired location.



To move an element from the location,

perform the following actions:

1. Expand the node corresponding to the desired location.
2. Drag the desired element to the network name or another location.

8. To save changes, at the bottom of the SmartPTT Radioserver Configurator window, click **Save Configuration** ().

Postrequisites:

- Update topology. For details, see [Updating Topology](#).
- To delete location, in the left pane of the tab, right-click the location name and select **Remove Location**.
- To apply changes immediately, at the bottom of the SmartPTT Radioserver Configurator window, click **Start** () or **Restart** ().

8.5.7 Configuring Local Stations Monitoring

Follow the procedure to configure control stations monitoring that will be displayed on the topology diagram in SmartPTT Dispatcher.

Prerequisites:

- Connect SmartPTT to local control stations. For details, see [MOTOTRBO Control Stations](#).
- Configure SmartPTT connection to the monitoring database. For details, see [Configuring Monitoring Database Connection](#).
- Configure SmartPTT connection to an external SNMP server. For details, see [Configuring SNMP Server Connection](#).
- Obtain the community string for the SNMP server.

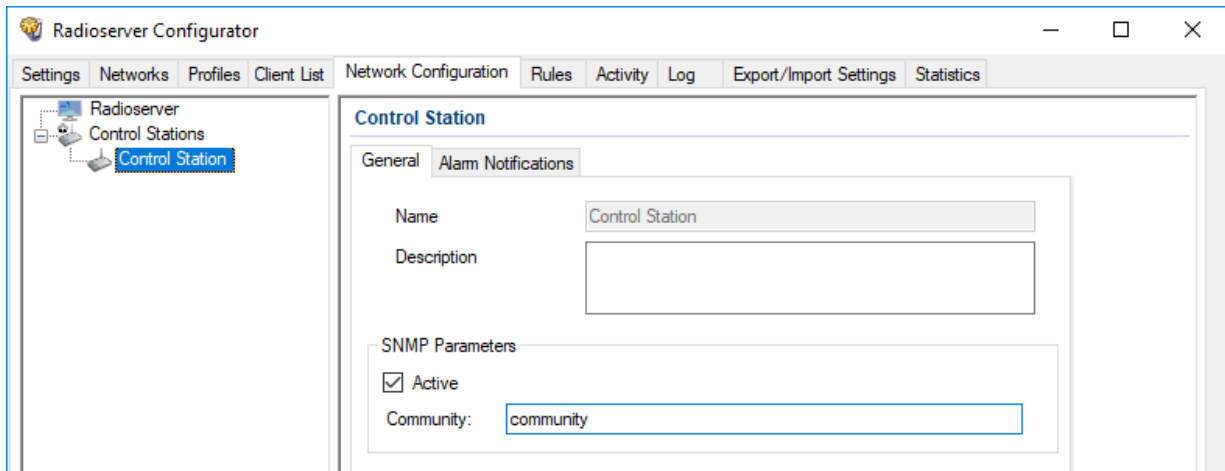

Procedure:

1. In SmartPTT Radioserver Configurator, open the **Network Configuration** tab.
2. In the left pane of the **Network Configuration** tab, expand the **Control Stations** node, and then select the desired control station.



3. In the **General** tab, in the **Description** field, type the description of a control station that will be displayed on a topology diagram in *SmartPTT Dispatcher*.
4. In the **SNMP parameters** area, select the **Active** check box.
5. In the **Community** field, type the community string of the SNMP server.
6. To save changes, at the bottom of the SmartPTT Radioserver Configurator window, click **Save Configuration** ().

Postrequisites:

- Configure alarm notifications. For details, see [Configuring Alarm Notifications](#).
- To apply changes immediately, at the bottom of the SmartPTT Radioserver Configurator window, click **Start** () or **Restart** ().

8.5.8 Configuring Remote Gateway Monitoring

Follow the procedure to configure the radio gateway monitoring in SmartPTT.

Prerequisites:

- Add the desired gateways and (if required) control station connections:
 - To connect MOTOTRBO stations, see [MOTOTRBO Radio Systems](#).
 - To connect stations over analog interface, see [Analog Interfaces](#).
- Configure SmartPTT connection to the monitoring database. For details, see [Configuring Monitoring Database Connection](#).
- Configure SmartPTT interface for an external SNMP server. For details, see [Configuring SNMP Server Connection](#).
- Obtain the community string for the SNMP server.

Procedure:

1. In SmartPTT Radioserver Configurator, open the **Network Configuration** tab.
2. In the left pane of the **Network Configuration** tab, expand **Remote Gateways**, and then select the desired gateway.

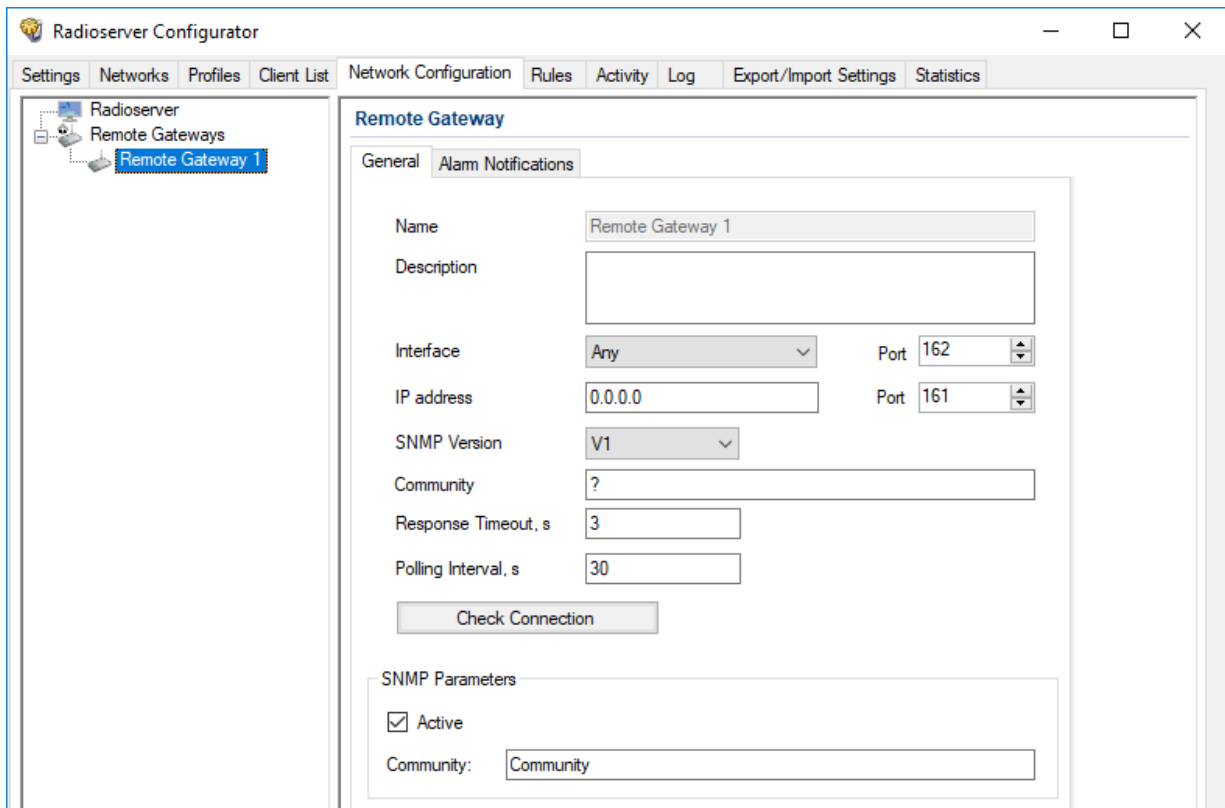

- In the right pane of the **Network Configuration** tab, open the **General** tab.



- In the **Description** field, type the radio gateway description.
- Configure the connection to a control station or a radio gateway:
 - From the **Interface** list, select the IP address of the SmartPTT Radioserver host for interacting with a radio gateway.
 - In the **Port** field, enter the SmartPTT Radioserver port number for interacting with a radio gateway.
 - In the **IP-address** field, type the IP address of a radio gateway.
 - In the **Port** field, enter the radio gateway port number.
- From the **SNMP Version** list, select the SNMP protocol that is used in the radio system.
- In the **Community** field, type a name of the community that is used for connection to a radio gateway over the SNMP protocol in the local network.
- In the **Response Timeout, s** field, type the amount of time in seconds during which SmartPTT Radioserver expects a response from a radio gateway.
- In the **Polling Interval, s** field, type the amount of time in seconds after which SmartPTT Radioserver sends a request to a radio gateway.
- Click the **Check Connection** button to check the status of the radio gateway connection. The window with information on the connection status appears.
- Configure sending radio gateway data to the SNMP service:
 - In the **SNMP Parameters** area, select the **Active** check box.

- b. In the field **Community**, type the community entry of the SNMP server.
12. To save changes, at the bottom of the SmartPTT Radioserver Configurator window, click **Save Configuration** ().

Postrequisites:

- Configure alarm notifications. For details, see [Configuring Alarm Notifications](#).
- To apply changes immediately, at the bottom of the SmartPTT Radioserver Configurator window, click **Start** () or **Restart** ().

8.5.8.1 Configuring Remote Control Stations Monitoring

Follow the procedure to configure the remote control stations monitoring that will be displayed on the topology diagram in SmartPTT Dispatcher.

Prerequisites:

- Add radio gateways and the desired control stations:
 - To connect MOTOTRBO stations, see [MOTOTRBO Radio Systems](#).
 - To connect stations over analog interface, see [Analog Interfaces](#).
- Configure SmartPTT connection to the monitoring database. For details, see [Configuring Monitoring Database Connection](#).
- Configure SmartPTT interface for an external SNMP server. For details, see [Configuring SNMP Server Connection](#).
- Obtain the community string for the SNMP server.

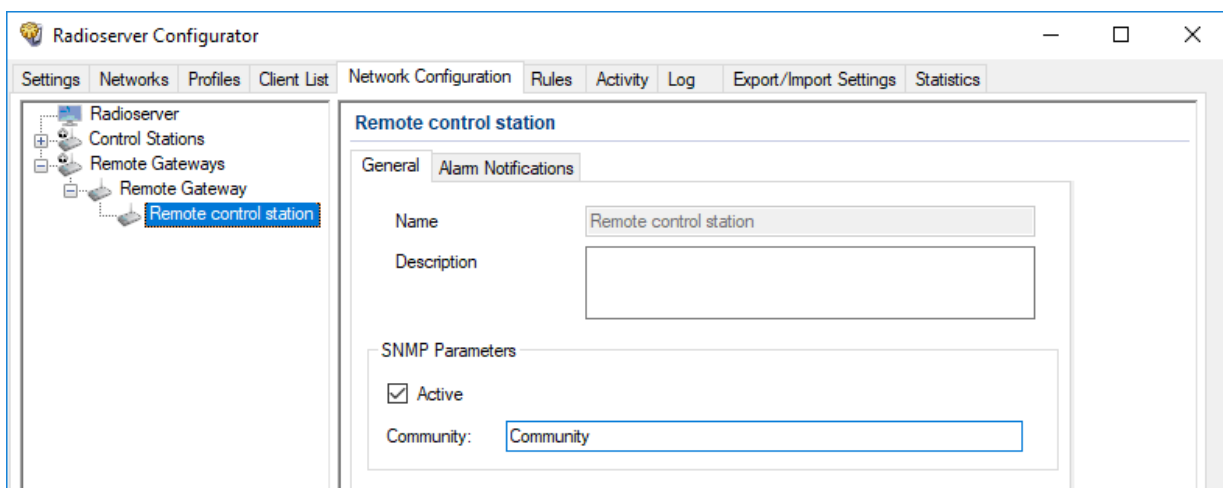

Procedure:

1. In SmartPTT Radioserver Configurator, open the **Network Configuration** tab.
2. In the left pane of the **Network Configuration** tab, expand **Remote Gateways** → **<remote gateway name>**, and then select the desired control station.
3. In the right pane, select the **General** tab.



4. On the **General** tab, in the **Description** field, type the description of a control station.
5. In the **SNMP parameters** area, select the **Active** check box.
6. In the **Community** field, type the community string of the SNMP server.
7. To save changes, at the bottom of the SmartPTT Radioserver Configurator window, click **Save Configuration** ().

Postrequisites:

- Configure alarm notifications. For details, see [Configuring Alarm Notifications](#).
- To apply changes immediately, at the bottom of the SmartPTT Radioserver Configurator window, click **Start** () or **Restart** ().

8.5.9 Configuring Alarm Notifications

Follow the procedure to configure automatic sending of alarm notifications during malfunctions in the radio system.

Prerequisites:

- Connect to radio systems. For details, see [MOTOTRBO Radio Systems](#).
- Connect SmartPTT to the monitoring database. For details, see [Configuring Monitoring Database Connection](#).
- Configure SmartPTT interface for an external SNMP server. For details, see [Configuring SNMP Server Connection](#).
- Configure SmartPTT connection to the mobile phone network. For details, see [Connecting to Phone Modems](#).
- Configure SmartPTT connection to the Email server. For details, see [Configuring Message Processing](#).
- Determine an object for which you want to configure alarm notifications. For details, see [Network Monitoring](#).
- Obtain identification receiver data (Email, telephone number, radio ID, the community entry used for authentication on the SNMP server etc.) to enter the **Receiver** dialog box.

Procedure:

1. In SmartPTT Radioserver Configurator, open the **Network Configuration** tab.
2. In the left pane of the tab, perform one of the following actions:

To configure notifications for a radioserver,	click <Radioserver name> .
To configure notifications for individual repeater networks,	expand <network type> and then click the desired child node.
To configure notifications for individual nodes of repeater systems,	perform the following actions: <ol style="list-style-type: none"> 1. Expand <network type> → <network name>. 2. If the desired element misses, expand the <location name> node. 3. Click the desired element.

To configure notifications for devices connected with control stations,

perform the following actions:

1. Expand **Control Stations**.
2. Click the desired element.

To configure notifications for alarms connected with all control stations that are not part of repeater systems,

click **Control Stations**.

To configure notifications for alarms connected with all control stations connected over the RG-1000e gateway,

expand the **Remote gateways** node, and then click the desired **<remote gateway name>** subnode.

To configure notifications for separate control stations,

Expand **Control Stations**, and then click the desired child node.

To configure notifications for separate remote control stations,

perform the following actions:

1. Expand the **Remote gateways** node.
2. Expand the **<remote gateway name>** node.
3. Click the **<control station name>** node.

3. In the right pane of the **Network Configuration** tab, open the **Alarm Notifications** tab.
4. In the **Alarms** area (if available), configure the desired alarms:

To configure sending of all alarm notifications,

click **Select All**.

To cancel sending of all alarm notifications,

click **Reset All**.

To configure manually the desired alarms about which notifications will be sent,

select or clear the desired alarms.

To configure alarms from network settings,

click **Apply Network Settings**.

5. In the tab, click **Add**.
The **Receiver** dialog box appears.

The image shows a 'Receiver' dialog box with the following fields and values:

- Type: SNMP
- Address (host:port): 0.0.0.0:162
- SNMP version: V1
- Realm: public

Buttons: OK, Cancel

6. In the open dialog box, specify receivers of notifications:

To send notifications to Email,

perform the following actions:

1. From the **Type** list, select the desired *Email*.
2. In the **Email** field, type the Email of a receiver.

NOTE

To send notifications to several Emails, you have to configure several notifications.

To send notifications to talkgroups,

perform the following actions:

1. From the **Type** list, select *Message (Talkgroup)*.
 2. From the **Control Station** list, select the desired slot, control station, or trunked system.
 3. From the **Talkgroup** list, select the desired talkgroup.
-

To send notifications to radios,

perform the following actions:

1. From the **Type** list, select *Message (Radio)*.
 2. In the **Radio ID** field, type ID of desired radios. Use hyphens to specify ranges and commas for enumeration of ID and ranges.
-

To send notification to SMS,

perform the following actions:

1. From the **Type** list, select *SMS*.
2. In the **Telephone** field, type the telephone number in international format.

NOTE

To send SMS to several telephone numbers you have to configure several notifications.

To send notifications to the SNMP server,



perform the following actions:

1. From the **Type** list, select *SNMP*.
 2. In the field **Address (host:port)**, type IP address and port number of the SNMP server in the following format: *<IP address in decimal format with dots>:<number of port>*.
 3. From the list **SNMP Version**, select the desired version of the SNMP protocol.
-

4. In the field **Community**, type the community entry used for authentication.

7. In the **Receiver** dialog box, click **OK** to apply changes.
8. To save changes, at the bottom of the SmartPTT Radioserver Configurator window, click **Save Configuration** ().

Postrequisites:

- Repeat the procedure to add other receivers of notifications.
- To apply changes immediately, at the bottom of the SmartPTT Radioserver Configurator window, click **Start** () or **Restart** ().

8.5.10 Updating Topology

Follow the procedure to update topology.

Prerequisites:

Connect SmartPTT Radioserver to the desired radio systems. For details, see [MOTOTRBO Radio Systems](#).

Procedure:

1. In SmartPTT Radioserver Configurator, open the **Network Configuration** tab.
2. In the left pane of the **Network Configuration** tab, expand <network type>, and then click <network name>.
3. In the right pane of the tab, open the **Network** tab.
4. In the **Network** tab, click **Update Topology**.

The **Topology Update** window appears and the update process starts automatically.

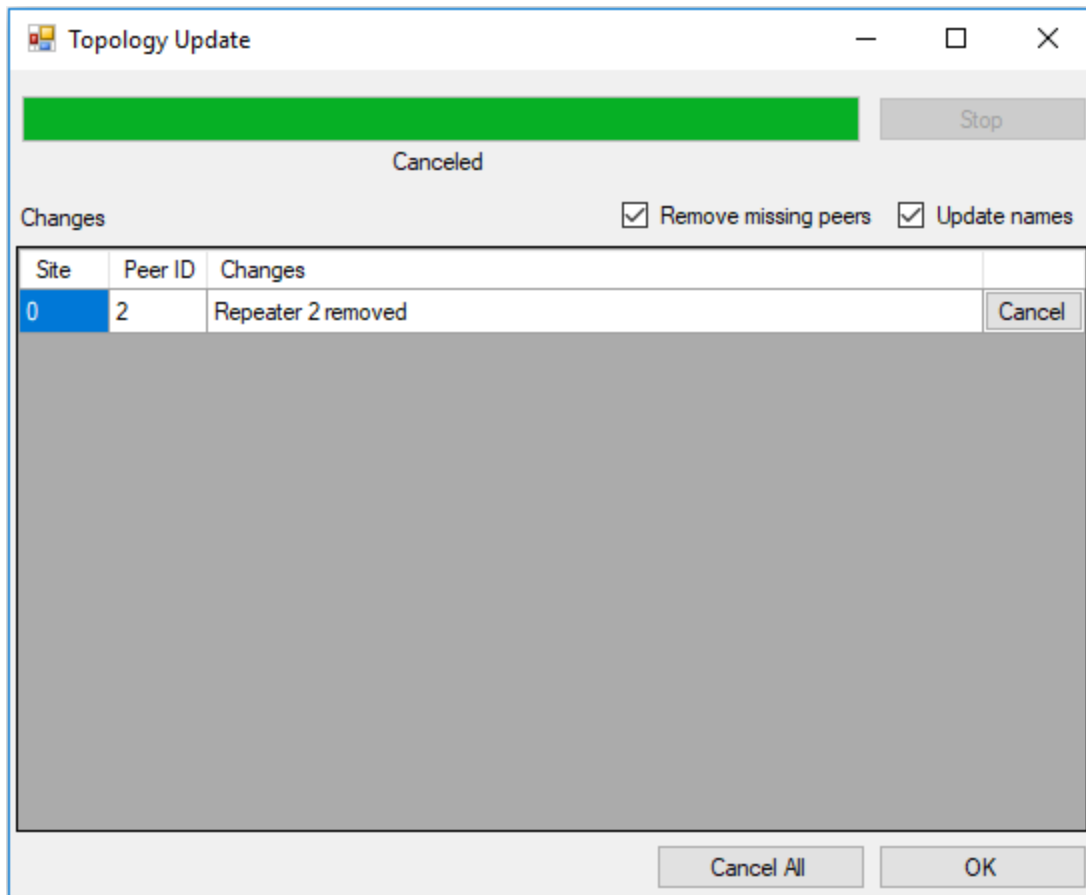

5. To change the topology update settings, perform the following actions:

To delete from topology missing nodes, select the **Remove missing peers** check box.

To replace the current repeater names by those defined in their configuration files, select the **Update names** check box.



To cancel changes for the desired node, click **Cancel** next to the desired node.

To cancel all changes, click **Cancel All**.

To interrupt the update process, click **Stop**.

6. Click **OK** to apply changes.
7. To save changes, at the bottom of the SmartPTT Radioserver Configurator window, click **Save Configuration** ().

Postrequisites:

To apply changes immediately, at the bottom of the SmartPTT Radioserver Configurator window, click **Start** () or **Restart** ().

8.6 Exporting Settings

Follow the procedure to export SmartPTT Radioserver settings and its database (optional).

Prerequisites:

Stop SmartPTT Radioserver by clicking the **Stop** (■) button at the bottom of SmartPTT Radioserver Configurator.

Procedure:

1. In SmartPTT Radioserver Configurator, open the **Export/Import Settings** tab.

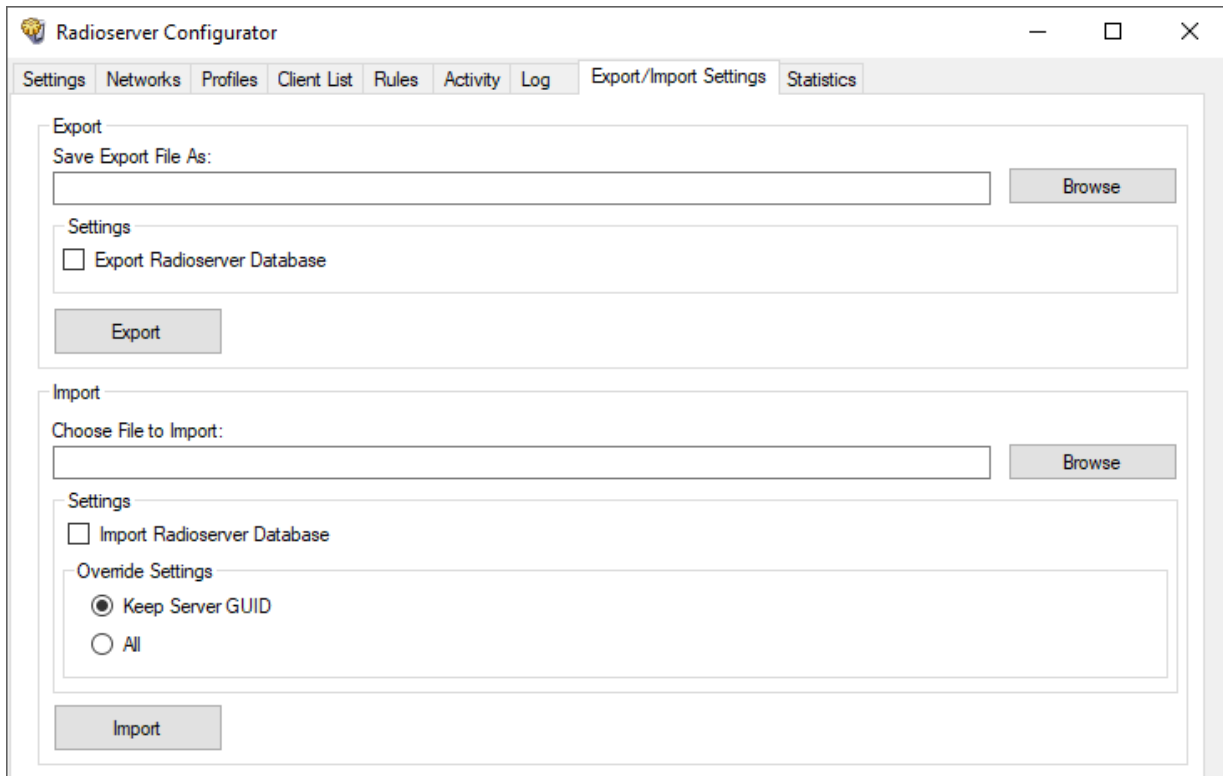

2. In the **Export** area at the top of the tab, specify the file to export settings into:
 - a. Click the **Browse** button to the right of the **Save Export File As** field.
 - b. In the window that appears choose the desired folder and type file name in the text field at the bottom of the window.
 - c. Click the **Save** button at the bottom of the window.
The specified path and file name are displayed in the **Save Export File As** field.

NOTE

You can also type or paste the full file path into this field.

3. (Optional) Select the **Export Radioserver Database** check box to include the SmartPTT Radioserver database into the same backup file.
4. Click the **Export** button.
If the operation is successful, a notification appears.
5. After successful exporting, in the dialog box, click **OK**.

8.7 Firewall Configuraiton

Firewall configuration is required for uninterrupted connection between SmartPTT components and communication systems. All port numbers below are default ones. They can be changed if required. However, some port ranges are limited. For details, see the corresponding documentation and/or embedded help files.

8.7.1 Radioserver Host

Table below provides information about network ports that must be unlocked on the radioserver host. For information on table conventions, see [Firewall Conventions](#).

DBMS CONNECTION

Value	Quantity	Initiator	Direction	Protocol
1433	1	RadioService.exe	out	TCP
1434	1	RadioService.exe	out	UDP

IP SITE CONNECT

Value	Quantity	Initiator	Direction	Protocol
-------	----------	-----------	-----------	----------

WIRELINE CONNECTION

Master repeater connection:

50000	1	RadioService.exe	out	UDP
-------	---	------------------	-----	-----

NETWORK APPLICATION INTERFACE

Master repeater connection:

50000	1	RadioService.exe	out	UDP
-------	---	------------------	-----	-----

DDMS connection:

3000	1	RadioService.exe	out	UDP
------	---	------------------	-----	-----

MNIS connection:

any	1	RadioService.exe	out	TCP
-----	---	------------------	-----	-----

Radio location updates over the LIP protocol:

5017	1	ext.	in	UDP
------	---	------	----	-----

Radio location updates over the LRRP protocol:

Value	Quantity	Initiator	Direction	Protocol
4001	1	RadioService.exe	out	UDP
		ext.	in	
Incoming and outgoing text messages:				
4007	1	RadioService.exe	out	UDP
		ext.	in	
Telemetry data and remote control commands:				
4008	1	RadioService.exe	out	UDP
		ext.	in	

MOTOTRBO™ CAPACITY PLUS

Value	Quantity	Initiator	Direction	Protocol
HYBRID INTERFACE				
Master repeater connection:				
50000	1	RadioService.exe	out	UDP
TX station connection:				
any	1	RadioService.exe	out	TCP and UDP
Radio location updates over the LIP protocol:				
5017	1	ext.	in	UDP
Radio location updates over the LRRP protocol (local TX stations only):				
4001	1	RadioService.exe	out	UDP
		ext.	in	
ARS information updates (local TX stations only):				
4005	1	RadioService.exe	out	UDP
		ext.	in	
Incoming and outgoing text messages (local TX stations only):				

Value	Quantity	Initiator	Direction	Protocol
4007	1	RadioService.exe	out	UDP
		ext.	in	
Telemetry data and remote control commands (local TX stations only):				
4008	1	RadioService.exe	out	UDP
		ext.	in	
Radio gateway connection for TX station control (remote TX stations only):				
1024	1	RadioService.exe	out	TCP
		ext.	in	
Radio gateway connection for voice and data communication (remote TX stations only):				
1024	1	RadioService.exe	out	UDP
		ext.	in	
Radio location updates over the LRRP protocol (remote TX stations only):				
1025	1	RadioService.exe	out	TCP and UDP
		ext.	in	
Incoming and outgoing text messages (remote TX stations only):				
1026	1	RadioService.exe	out	TCP and UDP
		ext.	in	
ARS information updates (remote TX stations only):				
1027	1	RadioService.exe	out	TCP and UDP
		ext.	in	
Telemetry data and remote control commands (remote TX stations only):				
1028	1	RadioService.exe	out	TCP and UDP
		ext.	in	
NETWORK APPLICATION INTERFACE				
Master repeater connection:				

Value	Quantity	Initiator	Direction	Protocol
50000	1	RadioService.exe	out	UDP
DDMS connection:				
3000	1	RadioService.exe	out	UDP
MNIS connection:				
any	1	RadioService.exe	out	TCP
Radio location updates over the LIP protocol:				
5017	1	ext.	in	UDP
Radio location updates over the LRRP protocol:				
4001	1	RadioService.exe	out	UDP
		ext.	in	
Incoming and outgoing text messages:				
4007	1	RadioService.exe	out	UDP
		ext.	in	
Telemetry data and remote control commands:				
4008	1	RadioService.exe	out	UDP
		ext.	in	

MOTOTRBO™ CAPACITY PLUS MULTI-SITE (LINKED CAPACITY PLUS)

Value	Quantity	Initiator	Direction	Protocol
Master repeater connection:				
50000	1	RadioService.exe	out	UDP
DDMS connection:				
3000	1	RadioService.exe	out	UDP
MNIS connection:				
any	1	RadioService.exe	out	TCP

Value	Quantity	Initiator	Direction	Protocol
Radio location updates over the LIP protocol:				
5017	1	ext.	in	UDP
Radio location updates over the LRRP protocol:				
4001	1	RadioService.exe	out	UDP
		ext.	in	
Incoming and outgoing text messages:				
4007	1	RadioService.exe	out	UDP
		ext.	in	
Telemetry data and remote control commands:				
4008	1	RadioService.exe	out	UDP
		ext.	in	

MOTOTRBO™ CAPACITY MAX

Value	Quantity	Initiator	Direction	Protocol
Connection to the single Presence Server (up to 5 connections is supported):				
any*	1	RadioService.exe	out	TCP
Radio location updates over the LIP protocol:				
5017	1	ext.	in	UDP
Radio location updates over the LRRP protocol through the primary MNIS data gateway:				
4001	1	RadioService.exe	out	UDP
		ext.	in	
Incoming and outgoing text messages through the primary MNIS data gateway:				
4007	1	RadioService.exe	out	UDP
		ext.	in	
Telemetry data and remote control commands through the primary MNIS data gateway:				

Value	Quantity	Initiator	Direction	Protocol
4008	1	RadioService.exe	out	UDP
		ext.	in	
Radio location updates over the LRRP protocol through the alternate/redundant MNIS data gateway:				
4011	1	RadioService.exe	out	UDP
		ext.	in	
Incoming and outgoing text messages through the alternate/redundant MNIS data gateway:				
4017	1	RadioService.exe	out	UDP
		ext.	in	
Telemetry data and remote control commands through the alternate/redundant MNIS data gateway:				
4018	1	RadioService.exe	out	UDP
		ext.	in	
Connection to the locally installed MNIS service:				
any	1	RadioService.exe	out	TCP
Connection to the remotely installed MNIS service:				
any	1	RadioService.exe	out	TCP

MOTOTRBO™ CONNECT PLUS

Value	Quantity	Initiator	Direction	Protocol
Connection to the network monitoring service that is hosted in XRC controllers:				
38000	1	RadioService.exe	out	TCP and UDP
Connection to the presence notification service (ARS) that is hosted in XRC contorollers:				
50005	1	RadioService.exe	out	TCP and UDP
Connection to the radio location service that is hosted in XRC controllers:				
50001	1	RadioService.exe	out	TCP and UDP
Connection to the text message service that is hosted in XRC controllers:				

Value	Quantity	Initiator	Direction	Protocol
50007	1	RadioService.exe	out	TCP and UDP

MOTOTRBO CONTROL STATION

Value	Quantity	Initiator	Direction	Protocol
Radio location updates over the LIP protocol:				
5017	1	ext.	in	UDP

Radio location updates over the LRRP protocol:				
4001	1	RadioService.exe	out	UDP
		ext.	in	

ARS information updates:				
4005	1	RadioService.exe	out	UDP
		ext.	in	

Incoming and outgoing text messages:				
4007	1	RadioService.exe	out	UDP
		ext.	in	

Telemetry data and remote control commands:				
4008	1	RadioService.exe	out	UDP
		ext.	in	

Radio gateway connection for TX station control (remote stations only):				
1024	1	RadioService.exe	out	TCP
		ext.	in	

Radio gateway connection for voice and data communication (remote stations only):				
1024	1	RadioService.exe	out	UDP
		ext.	in	

Radio location updates using the LRRP protocol (remote stations only):				
1025	1	RadioService.exe	out	TCP and UDP

Value	Quantity	Initiator	Direction	Protocol
		ext.	in	
Incoming and outgoing text messages (remote stations only):				
1026	1	RadioService.exe	out	TCP and UDP
		ext.	in	
ARS information updates (remote stations only):				
1027	1	RadioService.exe	out	TCP and UDP
		ext.	in	
Telemetry data and remote control commands (remote stations only):				
1028	1	RadioService.exe	out	TCP and UDP
		ext.	in	

ERDM REPEATER

Value	Quantity	Initiator	Direction	Protocol
Repeater connection:				
50000	1	RadioService.exe	out	UDP

DESKTOP CLIENT

Value	Quantity	Initiator	Direction	Protocol
Radioserver connection:				
any	1	ext.	in	TCP
Exchange voice traffic with the radioserver:				
18500*	1	RadioService.exe	out	UDP
		ext.	in	

WEB CLIENT

Value	Quantity	Initiator	Direction	Protocol
Local network connection:				

Value	Quantity	Initiator	Direction	Protocol
8443	1	ext.	in	TCP
STUN service:				
3478	1	ext.	in	TCP and UDP
Exchange voice traffic with the radioserver:				
18500*	1	RadioService.exe	out	UDP
		ext.	in	

SMARTPTT MOBILE, SMARTPTT SCADA, AND THIRD-PARTY APPS

Value	Quantity	Initiator	Direction	Protocol
Application connection:				
8191*	1	RadioService.exe	out	TCP
Exchange voice traffic with the radioserver:				
18500*	1	RadioService.exe	out	UDP
		ext.	in	

DDMS SERVICE

Value	Quantity	Initiator	Direction	Protocol
Radio presence information:				
any	1	RadioService.exe	out	TCP and UDP
Radio user information:				
5055	1	RadioService.exe	out	TCP and UDP

MNIS SERVICE

Value	Quantity	Initiator	Direction	Protocol
Local or remote MNIS connection:				
any	1	RadioService.exe	out	TCP and UDP

EMAIL SERVERS

Value	Quantity	Initiator	Direction	Protocol
Email Message Reception (IMAP or POP):				
any	1	RadioService.exe	out	TCP
Email Message Transmission (SMTP):				
any	1	RadioService.exe	out	TCP

SMARTPTT FILE TRANSFER

Value	Quantity	Initiator	Direction	Protocol
File Receive service:				
5001	1	RadioService.exe	out	UDP

PHONE LINE CONNECTION OVER SIP TRUNK

Value	Quantity	Initiator	Direction	Protocol
Control connection:				
5060	1	RadioService.exe	out	TCP or UDP
Full-duplex voice communication with individual phone:				
18650	300	RadioService.exe	out	UDP

OPTION BOARD FEATURES

Value	Quantity	Initiator	Direction	Protocol
Heartbeats:				
5000	1	ext.	in	UDP
Location Reports:				
4010	1	ext.	in	UDP

INDOOR TRACKING USING KILCHHERR

Value	Quantity	Initiator	Direction	Protocol
Location reports reception:				
3100	1	ext.	in	UDP

NEXLOG RECORDING SYSTEM

Value	Quantity	Initiator	Direction	Protocol
Voice streams reception:				
13000	200	RadioService.exe	out	UDP

AVIGILON CONNECTION

Value	Quantity	Initiator	Direction	Protocol
any	1	RadioService.exe	out	TCP and UDP

NETWORK MONITORING

Value	Quantity	Initiator	Direction	Protocol
Listening to requests from the SNMP server:				
161	1	ext.	in	TCP and UDP

8.7.2 Dispatch Console Host

Table below provides information about network ports that must be unlocked on dispatch console computers. For information on table conventions, see [Firewall Conventions](#).

Value	Quantity	Process	Direction	Protocol
Radioserver connection:				
any	1	Client.exe	out	TCP
Voice reception from the radio network and voice transmission to the radio network over the radioserver; voice reception from another dispatcher and voice transmission to another dispatcher:				
18501	1	Client.exe	out	UDP
Connection to another dispatch console (for console intercom) and data transmission:				

Value	Quantity	Process	Direction	Protocol
18501	1	Client.exe	out	TCP
Connection to PBX over the SIP trunk protocol (transport protocol depends on PBX settings):				
5060	1	Client.exe	out	TCP or UDP
Voice reception and transmission between dispatch console and PBX:				
18700	48	Client.exe	out	UDP

8.7.3 Firewall Conventions

List of ports that must be unlocked for uninterrupted communication is available in the table view. Corresponding tables consist of the following columns:

Value

Number of the single port or the initial boundary of the port range (interpretation depends on the **Quantity** column). In the column, the following options are available:

- *any* — port number is selected automatically.
- *<port number>* — default port number.
- *<port number>** — port number can be used for simultaneous use by multiple connections.

Quantity

Number of ports that must be unlocked (including the one that is specified in the **Value** column):

- *<number of ports>* — number of ports in the range.

Initiator

Name of the process that initiates the connection. In the column, the following options are available:

- *RadioService.exe* — name of the radioserver process (available for both main/primary and alternate/redundant radioservers).
- *Client.exe* — name of the SmartPTT Dispatcher process (available on dispatch console computers only).
- *ext.* — reference that the connection is initiated by an external process.

Direction

Shows if the connection request is incoming/inbound or outgoing/outbound. In the column, the following options are available:

- *in* — incoming/inbound request.
- *out* — outgoing/outbound request.

Protocol

Type of the transport protocol that is used for data provision. In the column, the following options are available:

- *TCP* — transmission control protocol.

- *UDP* — user datagram protocol.

Brief description of each connection is provided in the table before the connection parameters (port numbers, quantities etc.).

9 Alternation (Redundancy)

SmartPTT supports operation with the primary and redundant radioservers. The redundant radioserver is activated in case of primary radioserver breakdown. Switching between radioservers is made automatically, however, the redundant radioserver is activated only if the last connection to the primary radioserver was no later than 31 days ago.

The primary radioserver can have only one redundant radioserver.

Important

To activate a redundant radioserver, install the corresponding license. For details, see Licenses.

If synchronization with primary radio server is enabled, the redundant server settings are synchronized with the primary server in the continuous one way direction copy mode. The primary server operates in the normal mode, the backup server constantly synchronizes its settings with the settings of the primary one.

For the proper operation of the redundant radioserver, values and parameters of primary and redundant radioservers must not be the same. For this, you need to set new parameter values for a redundant radioserver in the correspondence table. For information on the correspondence table, see [Configuring the Correspondence Table](#). If the primary radioserver settings were changed after the redundant radioserver start, you need to update the correspondence table.

NOTE

After configuring redundant and primary radioservers, you need to add them in SmartPTT Dispatcher. For information on adding radioservers, see "Radioservers" in *SmartPTT Dispatcher Guide*.

9.1 Configuring Redundant Radioserver

Follow the procedure to add and configure the redundant radioserver.

Prerequisites:

- Ensure all parameters of the primary radioserver are saved, and it is running. If the parameters were changed, save the changes and restart the primary radioserver to apply the changes to the redundant radioserver.
- Obtain the primary radioserver IP address.

Procedure:

1. In the SmartPTT Radioserver Configurator open the **Settings** tab.
2. In the left pane of the **Settings** tab, click **Radio Server**.

3. In the **Radio Server** pane, from the **Server Role** list, select *Redundant*.
In the left pane, the **Redundant Radio Server** node appears.

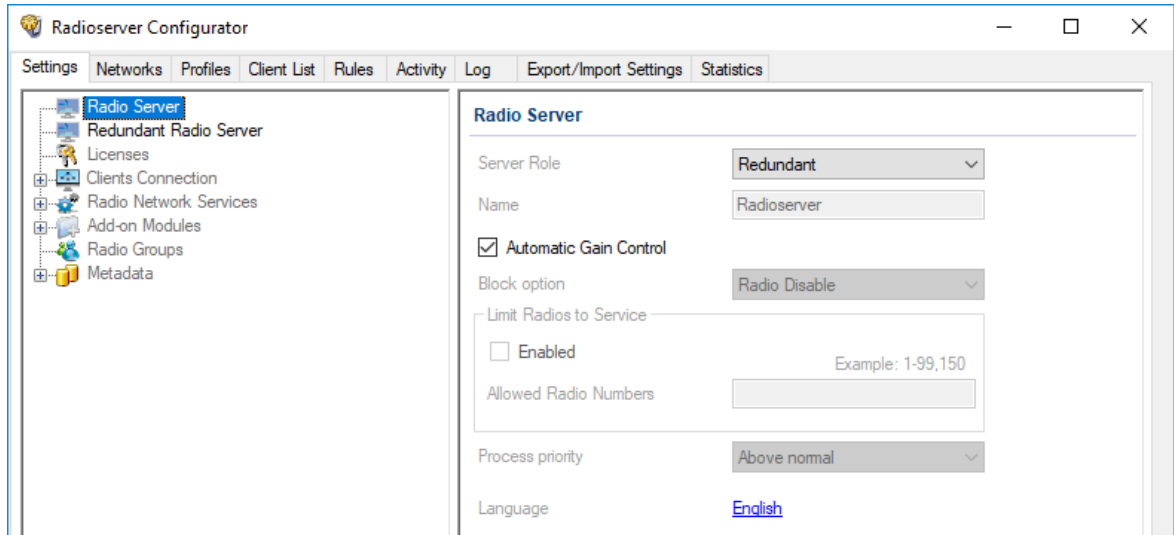

4. In the left pane of the **Settings** tab, click **Redundant Radio Server**.
In the right pane of SmartPTT Radioserver Configurator, the redundant radioserver settings appear.

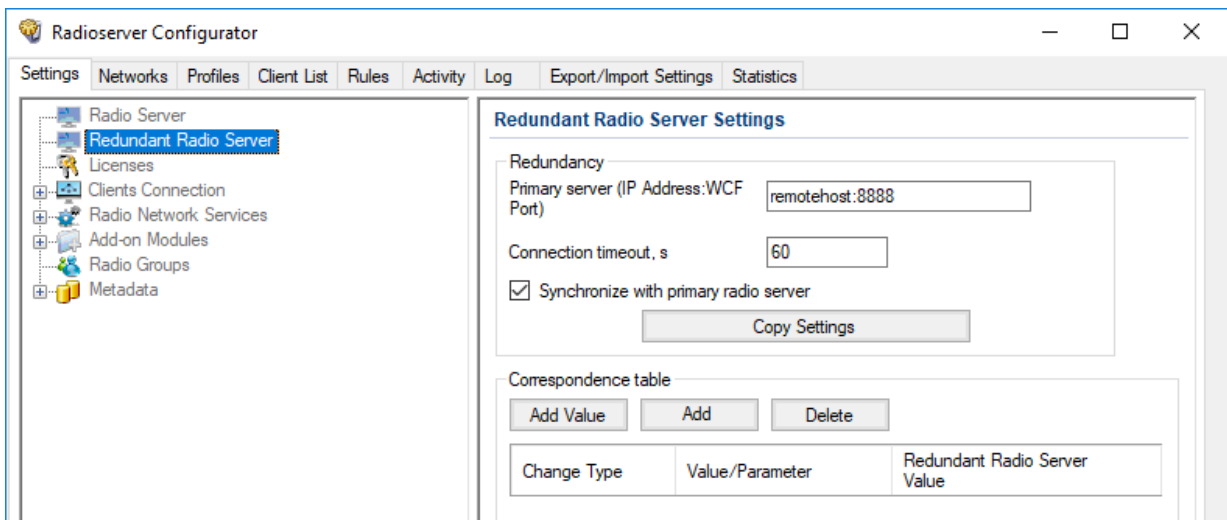

5. In the **Redundancy** area, perform the following actions:
 - a. In the **Primary Server (IP Address:WCF Port)** check box, type the primary radioserver IP address and port.
 - b. (Optional) In the **Connection timeout, s** field, type time interval after which the redundant radioserver becomes active.
 - c. Perform one of the following actions:

To copy primary radioserver settings to the redundant radioserver,

click **Copy Settings**.

To activate the automatic synchronization of the redundant radioserver with the primary one after the primary radioserver restart,

select the **Synchronize with primary radio server** check box.

6. Configure the correspondence table.
For information on configuring the table, see [Configuring the Correspondence Table](#).

9.1.1 Configuring the Correspondence Table

Follow the procedure to configure the correspondence table for the redundant radioserver.

Prerequisites:



- Ensure all parameters of the primary radioserver are saved, and the radioserver is started.
- Ensure, in the **Redundancy** area, the **Synchronize with primary radio server** check box is selected.

Procedure:

1. In the correspondence table, set or edit the existing values or parameters for replacing.
For details, see [Setting Values](#) and [Setting Parameters](#).
2. *(Optional)* To sort entries in the table, perform the following actions:

To sort entries ascending,	click the desired column heading until the Ascending Icon (▲) appears on the right of the heading.
To sort entries descending,	click the desired column heading until the Descending Icon (▼) appears on the right of the heading.

NOTE
Entries are sorted only by one column, clicking the name of another column automatically discards the sorting order applied earlier.

3. To save changes, at the bottom of the SmartPTT Radioserver Configurator window, click **Save Configuration** ().
4. To apply changes immediately, at the bottom of the SmartPTT Radioserver Configurator window, click **Start** () or **Restart** ().

9.1.1.1 Setting Values

Follow the procedure to set a replacing value for the redundant radioserver in the correspondence table.

Important
The value in the correspondence table changes all similar values copied from the primary radioserver parameters.

Procedure:

1. In the **Correspondence table** area, click **Add Value**.
In the correspondence table below, a new entry appears.
2. In the desired entry, in the **Value/Parameter** column, type the desired value for replacing.

3. In the desired entry, in the **Redundant Radio Server Value** column, type a new value for the redundant radioserver.

Postrequisites:

To edit a value in the **Value/Parameter** or **Redundant Radio Server Value** columns, double-click the desired entry in the correspondence table, and then type a new value.

9.1.1.2 Setting Parameters

Follow the procedure to set a replacing parameter for the redundant radioserver in the correspondence table.

Procedure:

1. In the **Correspondence table** area, click **Add**.
The **Parameter Overriding** window appears.
2. In the left pane of the **Parameter Overriding** window, select the desired tab (**Settings** or **Networks**), and then expand the desired node.
In the right pane, the area for selecting the parameter and its value appears.
3. From the **Parameter** list, select the desired parameter:
 - For IP Site Connect, Capacity Plus, NAI - IP Site Connect, NAI - Capacity Plus and NAI - Linked Capacity Plus replace **Peer ID** parameter values.
 - *(Optional)* Replace IP-addresses.
 - *(Optional)* Replace databases names.
 - For NAI - IP Site Connect, NAI - Capacity Plus, NAI - Extended Range Direct Mode and NAI - Linked Capacity Plus networks, select the **Active** check box for the **DDMS mode control** parameter to establish dependence of the redundant server DDMS activity from the DDMS activity of the primary server.

NOTE

If the **Synchronize with primary radio server** check box is cleared, this check box is transferred to the **DDMS Settings** node of each network, respectively. If the **DDMS Mode Control** check box is cleared, the activity of the redundant server does not affect the activity of DDMS whose address is specified in the settings of the redundant server.

NOTE

If you configure **Clients Connection**, you do not need to replace its parameters for the redundant radioserver.

4. In the **Value** area, set the value in one of the following ways:
 - Type the value in the field.
 - Select the value from the list.
 - Select/clear the check box.
5. Click **Add** to add the parameter to the correspondence table.
6. Click **Finish** to close the window.

Postrequisites:

To edit a parameter or its value, double-click the desired entry in the correspondence table, and then select another parameter, or change the selected earlier value.

10 Maintenance

The chapter provides information on the operating SmartPTT observation as well as its configuration and database restoration.

10.1 Viewing System Events

Follow the procedure to view radioserver-detected events.

Procedure:

1. In SmartPTT Radioserver Configurator, open the **Activity** tab.

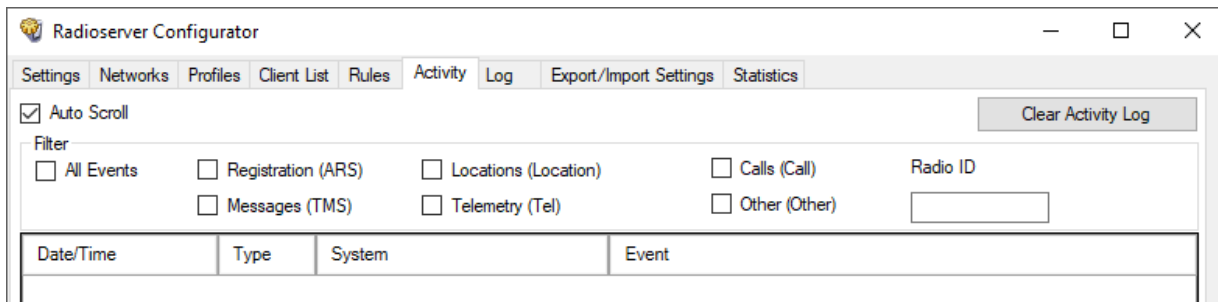

2. *(Optional)* To turn on automatic event scrolling and show the most recent events, select the **Auto Scroll** check box.
3. In the **Filter** area, filter the desired events:

To show all events,

select the **All Events** check box.

To show registration events only,

select the **Registration (ARS)** check box.

To show text messaging events only,

select the **Messages (TMS)** check box.

To show location-related events only,

select the **Locations (Location)** check box.

To show telemetry and remote control events only,

select the **Telemetry (Tel)** check box.

NOTE

The check box does not affect SmartPTT SCADA events.

To show voice reception/transmission events only,

select the **Calls (Call)** check box.

To show any other events,

select the **Other (Other)** check box.

To show events related to one or multiple Radio IDs only,

in the **Radio ID** field, type radio IDs. Use hyphens to type ID ranges; use commas to list IDs and ID ranges.

4. *(Optional)* To sort events by the **Date/Time** column and/or **Type** column, perform the following actions:

To sort events ascending,	click the column header until the Ascending (▲) icon appears in it.
To sort events descending,	click the column header until the Descending (▼) icon appears in it.

5. *(Optional)* To delete entries from the table (not from the database), clear **Clear Activity Log**.

10.1.1 Event Types

SmartPTT provides information on the following types of events on the radio network:

- Radio registration
- Voice calls and their equivalents, for example, voice notifications
- Text messages
- Location reports
- Telemetry signals and remote control commands
- Various other types of events, such as radio commands

Description of these types of events is given below.

Registration (ARS)

Registration-related events are displayed on the **Activity** tab as follows:

- Event direction indicator (<-) (->)
- Radio IP address and identifier (in decimal) in the format <IP address> (<identifier>)
- Additional information

EXAMPLE

The attempt to obtain information about the radio with the 902 identifier presence in the network is failed:

12.0.3.134 (902) Inaccessible

Location

Location-related events are displayed on the **Activity** tab as follows:

- Event direction indicator (<-) (->)
- Radio IP address and identifier (in decimal) in the format <IP address> (<identifier>)
- Request number
- Additional information

EXAMPLE

Radio with the 417 identifier has the following location coordinates on 2020.01.01 at 01:00:01: Latitude = 56,47907. Longitude = 85,06649.

12.0.1.161 (417) Triggered Location Report id = 5 Latitude = 56,47907. Longitude = 85,06649 Timestamp: 01.01.2020 01:00:01

Call

Call-related events are displayed on the **Activity** tab as follows:

- Voice transmission type
- Voice direction indicator in the format *<initiator ID> (<recipient ID>)*
- Additional information

EXAMPLE

Outgoing voice transmission from a dispatcher to the radio with the 445 identifier:

Private (Dispatcher) 1 -> 445 Tx

Text messages

Text message-related events are displayed on the **Activity** tab as follows:

- Message direction indicator in the format *(<sender ID> -> <recipient ID>)*
- The recipient and sender identifier in the format *<IP address> (<identifier>)*
For IP addresses the following convention is applied:
 - If the first octet of the IP address corresponds to the CAI value of the network, then the recipient or sender is the radio.
 - If the first octet of the IP address corresponds to the CAI value of the group, then the recipient or sender is the talkgroup.
- Additional information

EXAMPLE

The radio with the 417 identifier sends a message to the radio with the 1 identifier:

-> 12.0.1.161 (417) -> 12.0.0.1 (1) Simple TextMessage Need help

Telemetry

Telemetry-related events are displayed on the **Activity** tab as follows:

- Event subtype.
- Radio IP address and identifier (in decimal) in the format *<IP address> (<identifier>)*
- Request number
- Additional information

EXAMPLE

Incoming telemetry command when opening the door:

Telemetry response. IP – 12.0.0.7; id= 54 type= Individual; opcode= QueryStatusResponse; payload= 00001000

Other

Other events can have different displaying structure on the **Activity** tab.

EXAMPLE

Telephone call to the talkgroup:

- > INVITE; From:sip: 1859@82.200.114.46:5060; To:sip:21@192.168.36.110:5060;

< - Ringing(180); From:sip: 1859@82.200.114.46:5060; To:sip:21@192.168.36.110:5060;

< - OK(200); From:sip: 1859@82.200.114.46:5060; To:sip:21@192.168.36.110:5060;

- > ACK; From:sip: 1859@82.200.114.46:5060; To:sip:21@192.168.36.110:5060;

- > BYE; From:sip: 1859@82.200.114.46:5060; To:sip:21@192.168.36.110:5060;

< - OK(200); From:sip: 1859@82.200.114.46:5060; To:sip:21@192.168.36.110:5060;

10.1.2 Alarm Text Messages on Devices

Alarm text messages on devices are displayed in the following way:

- Outgoing text message direction indicator (<-)
- The recipient identifier in the format *<IP address> (<identifier>)*
For IP addresses the following convention is applied:
 - If the first octet of the IP address corresponds to the CAI value of the network, then the recipient or sender is the radio.
 - If the first octet of the IP address corresponds to the CAI value of the group, then the recipient or sender is the talkgroup.
- Service text SimpleTextMessage
- The device name in the format
Name : <device name>

- The device location in the format
Location : <location name>
- The device ID as on the **Network Configuration** tab
- A multiple hyphen delimiter
- The list of alarms in the format
<alarm name> : -

EXAMPLE

< - 12.0.2.88 (600) SimpleTextMessage Name : dms:rest@3.peers.55 Location : NAI- Linked Capacity Plus 213 Identifier : 3001 ----- Repeater overheat : - Amplifier Fan Failure : -

10.2 Importing Settings

Follow the procedure to import SmartPTT Radioserver settings and database (optional).

Prerequisites:

Stop SmartPTT Radioserver by clicking the **Stop** (■) button at the bottom of SmartPTT Radioserver Configurator.

Procedure:

1. In SmartPTT Radioserver Configurator, open the **Export/Import Settings** tab.

2. In the **Import** area, specify the file to import settings from:
 - a. Click the **Browse** button to the right of the **Choose File to Import** field.

- b. In the window that appears choose the desired file containing exported server settings.
- c. Click the **Open** button at the bottom of the window.
The specified path and file name are displayed in the **Choose File to Import** field.

NOTE

You can also type or paste the full file path into this field.

3. *(Optional)* Import radioserver database from the same file:
 - a. Select the **Import Radioserver Database** check box to import the exported databases from the same file.
 - b. In the **Override Settings** area, determine GUID restoration necessity:

If the current radioserver will work together with the one which settings are imported, click **Keep Server GUID**.

If the current radioserver completely replaces the previous radioserver or the current radioserver is a restored instance of the failed radioserver, click **All**.

4. Click the **Import** button, and then confirm the importing.

Postrequisites:

To apply changes immediately, at the bottom of the SmartPTT Radioserver Configurator window, click **Start** (▶) or **Restart** (▶▶).

10.3 Restoring Event Log Database

Follow the procedure to restore the radioserver event log database from a backup.



Prerequisites:

Ensure that you have access to the desired backup file (.bak).

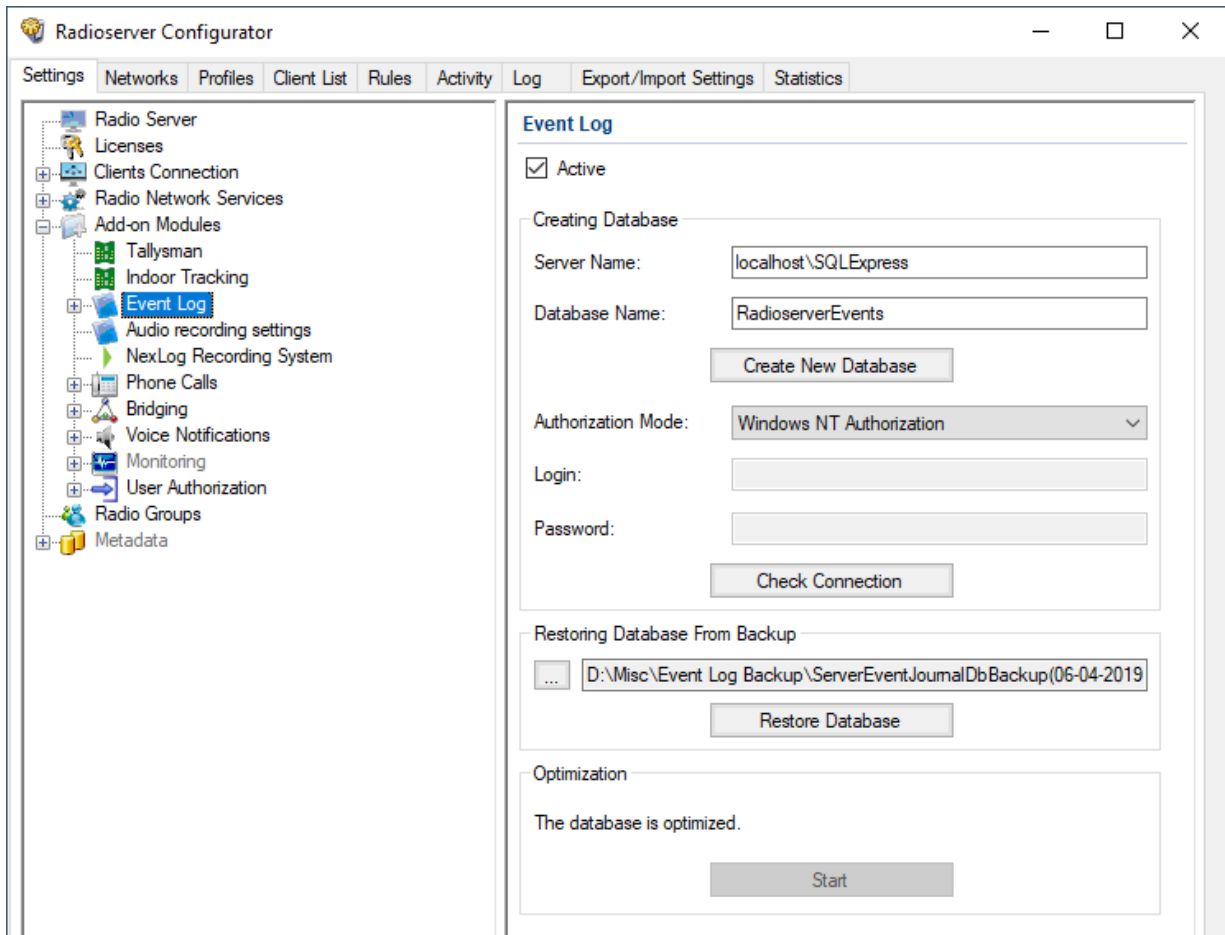

Procedure:

1. In SmartPTT Radioserver Configurator, open the **Settings** tab.
2. In the left pane, expand the **Add-on Modules** node, and then click **Event Log**.
The database connection settings appear in the right pane.



3. In the **Restoring Database From Backup** area, specify the path to the backup file:
 - a. Click the Browse () button to the left of the text field.
The dialog box appears.
 - b. In the dialog box, select the file.
4. Click **Restore Database**.
A dialog box with information about the restore process appears.
5. When the restoration completes, in the dialog box, confirm the restoration completion.
6. To save changes, at the bottom of the SmartPTT Radioserver Configurator window, click **Save Configuration** ().

Postrequisites:

To apply changes immediately, at the bottom of the SmartPTT Radioserver Configurator window, click **Start** () or **Restart** ().

10.4 Restoring Monitoring Database

Follow the procedure to restore the monitoring database from a backup.



Prerequisites:

Ensure that you have access to the desired backup file (.bak).

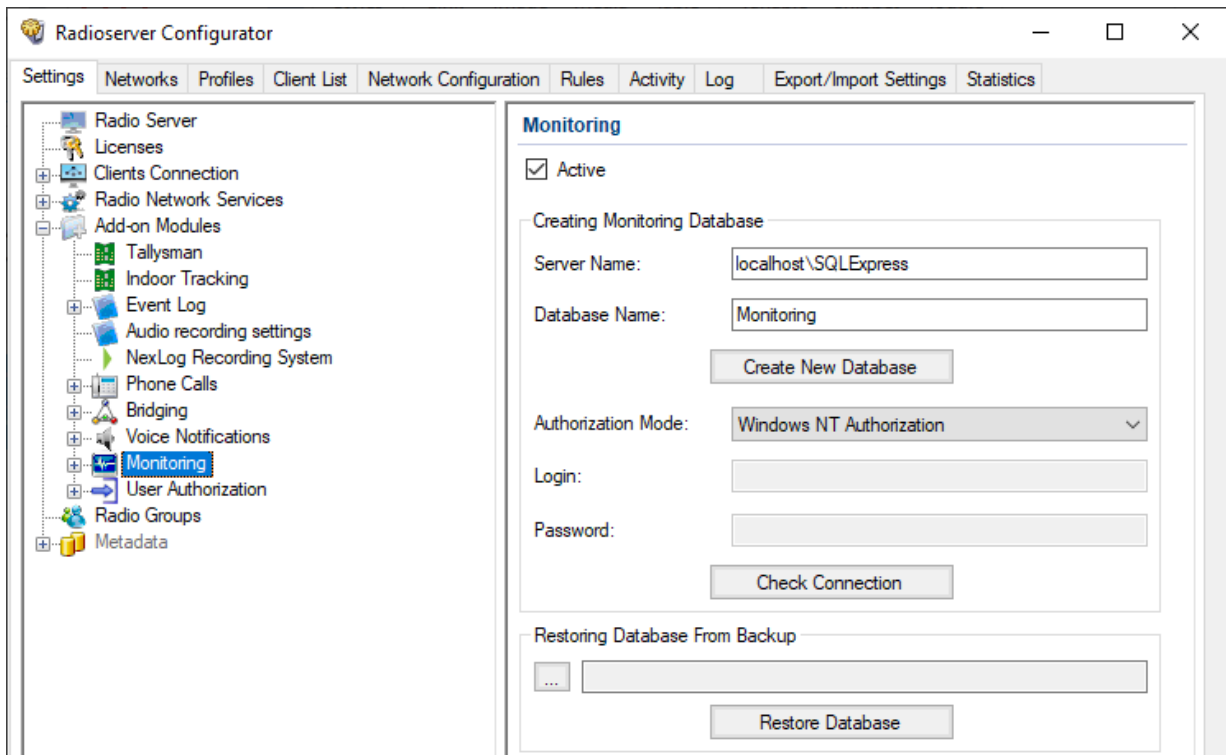

Procedure:

1. In SmartPTT Radioserver Configurator, open the **Settings** tab.
2. In the left pane, expand the **Add-on Modules** node, and then click **Monitoring**.
The database connection settings appear in the right pane.



3. In the **Restoring Database From Backup** area, specify the path to the backup file:
 - a. Click Browse () to the left of the text field.
The dialog box appears.
 - b. In the dialog box, select the file.
4. Click **Restore Database**.
5. When the restoration completes, in the dialog box, confirm the restoration completion.
6. To save changes, at the bottom of the SmartPTT Radioserver Configurator window, click **Save Configuration** ().

Postrequisites:

To apply changes immediately, at the bottom of the SmartPTT Radioserver Configurator window, click **Start** () or **Restart** ().

10.5 Restoring User Database

Follow the procedure to restore the radio user database from a backup.



Prerequisites:

Ensure that you have access to the desired backup file (.bak).

Procedure:

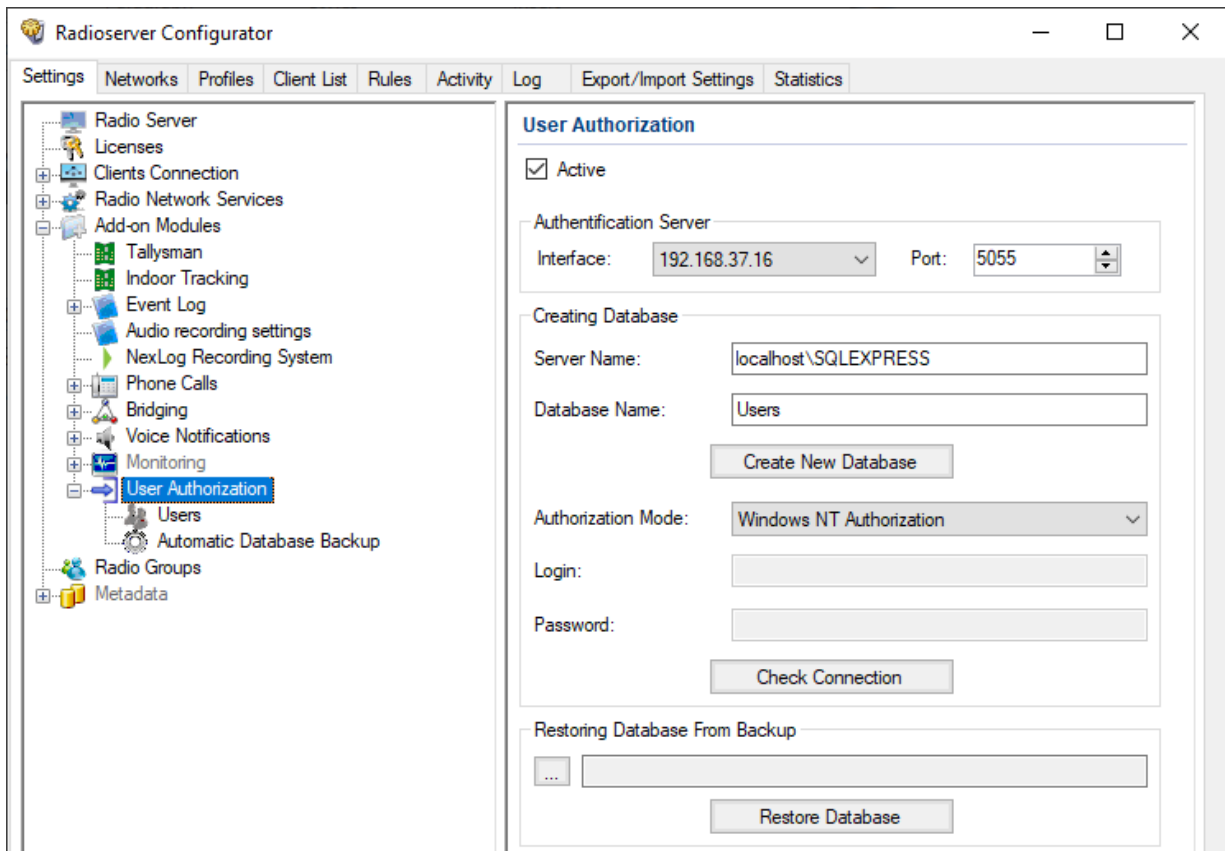
1. In SmartPTT Radioserver Configurator, open the **Settings** tab.
2. In the left pane, expand the **Add-on Modules** node, and then click **User Authorization**.
The database connection settings appear in the right pane.



3. In the **Restoring Database From Backup** area, specify the path to the desired backup file:
 - a. Click the Browse () button to the left of the text field.
The dialog box appears.
 - b. In the window that appears, select the desired file and click **Open**.
4. Click **Restore Database**.
5. When the restoration completes, in the dialog box, confirm the restoration completion.
6. To save changes, at the bottom of the SmartPTT Radioserver Configurator window, click **Save Configuration** ().

Postrequisites:

To apply changes immediately, at the bottom of the SmartPTT Radioserver Configurator window, click **Start** () or

Restart ().

11 Troubleshooting

The section provides description of typical problems you may encounter while installing and configuring SmartPTT software. It provides information on their possible reasons and ways of their resolving. If the suggested methods do not help to resolve your problem, contact [SmartPTT Technical Support Center](#).

11.1 General Recommendations

Many problems related to the SmartPTT configuration and/or operation occur due to the incomplete infrastructure configuration. Such problems are usually appear as applications start failure.

To resolve such problems, the following recommendations must be followed:

- Always install drivers for sound cards, network cards, and other peripherals.
- Use compatible hardware and software.
- Always restart your computers after the operating system update installation and/or other software updates installation.

11.2 SmartPTT Installation Problems

If the installation of the SmartPTT software completed successfully, a message confirming successful installation appears. If the message does not appear, it means a problem occurred during the installation. It may occur for one of the following reasons:

- You logged on using a non-administrator account (standard or guest account).
- Microsoft .NET Framework is not installed on the computer.
- The components required for correct SmartPTT operation, such as MOTOTRBO Radio Driver, Microsoft SQL Server were not installed.
- Installed Windows updates are not up-to-date or do not meet the system requirements.

To resolve installation-related problems, perform the following actions:

1. Log on as an Administrator.
2. Restart the installation of the SmartPTT software, and install all additional components offered by the installer:
 - If offered, agree to install Microsoft .NET Framework.
 - Agree to install MOTOTRBO Radio Driver.
 - Install Microsoft SQL Server if it is not installed.

For more information on the installation procedure, see [Software Installation](#).

3. Ensure that Windows updates are up-to-date and meet the SmartPTT system requirements.
For more information on Windows updates, see [Microsoft Download Center](#) and [System Requirements](#).

11.3 SmartPTT Startup Problems

On successful launch of SmartPTT Dispatcher or SmartPTT Radioserver Configurator, the main window of the corresponding program opens automatically. If the window does not appear, the program did not launch because of a startup problem. It may occur for one of the following reasons:

- The computer was not restarted after the Microsoft .NET Framework installation.
- SmartPTT was installed to a folder other than Program Files (x86) on a computer with a 64-bit version of Windows.
- SmartPTT license period expired.
- Version of the installed Microsoft SQL Server does not correspond to the versions specified in *SmartPTT System Requirements*.
- Multiple versions or multiple editions of Microsoft SQL Server are installed on the computer.
- SQLService is not running.

To resolve startup-related problems, check out the following measures:

- Restart your computer if it was not restarted after Microsoft .NET Framework installation. After restart, restart the installation, and then, in the **Program Maintenance** window, select **Modify**. Follow the instructions provided by the SmartPTT installer.
- If SmartPTT was installed to a folder other than Program Files (x86) on a computer with a 64-bit version of Windows, uninstall it, and then reinstall to the Program Files (x86) folder.
- If SmartPTT license period expired, install a valid license or contact [SmartPTT Technical Support Center](#).
- Ensure that the Microsoft SQL Server version meets the requirements specified in *SmartPTT System Requirements*.
- Ensure that only one version and edition of Microsoft SQL Server is installed on the computer (**Control Panel** → **Programs** → **Programs and Features**).
- Ensure that the SQL Server service is running (**Task Manager** → **Services**). If the service is not running, start it.

11.4 Problems with Databases

A problem may occur when you connect the SmartPTT server or client to the database and in the course of further database-related activities in the SmartPTT system. It may occur for one of the following reasons:

- Version of the installed Microsoft SQL Server does not meet the requirements specified in *SmartPTT System Requirements*.
- Multiple versions or multiple editions of Microsoft SQL Server are installed on the computer.
- The SQL Server service is not running.
- Incorrect SQL Server address in SmartPTT Radioserver Configurator.
- For the SQL authorization method, incorrect SQL user credentials.
- For systems connected to a remote database, the remote host is unavailable.

To resolve database-related problems, check out the recommendations below:

- Ensure that the Microsoft SQL Server version meets the requirements specified in *SmartPTT System Requirements*.
- Ensure that only one version and edition of Microsoft SQL Server is installed on the computer (**Control Panel** → **Programs** → **Programs and Features**).
- Ensure that SQL Server service is running (**Task Manager** → **Services**). If the service is not running, start it.
- In SmartPTT Radioserver Configurator, specify the IP address of the computer on which SQL server is installed and running.
- For the SQL authorization method, specify correct SQL user credentials.
- Ensure that the remote host becomes available when using a remote database. For example, use the command `ping <host IP address>`.

Contact Information

The document describes the product developed by Elcomplus LLC. The official company's website is www.elcomplus.com.

For contact information with the Elcomplus LLC representatives, see www.elcomplus.com/contacts.

Technical Support

Customer support is provided by Technical Support Center. The official website of the Center is support.smartptt.com.

To contact the support engineer, perform one of the following actions:

- Fill in and submit the [support request](#) from the website.
- Email the support request to support@smartptt.com.

In America, customer support is provided by Elcomplus, Inc. To contact support engineers, use the following contact information:

- Phone: +1 786-362-5525
- Email: miami@smartptt.com
- Mailbox: 290 NW 165th St, Ste P-200, 3rd Flr
Miami, FL, 33169, USA

Technical Support Center and Elcomplus, Inc. do not consult on deployment and maintenance of Motorola Solutions products except on settings related to SmartPTT connection and data communication. For the technical support on Motorola Solutions products, please contact authorized Motorola Solutions representative in your region.

Customer Documentation

This document is authored and published by Elcomplus LLC. If you have any comments and suggestions on it, please email them to support@smartptt.com.

Not part of this document must be reproduced, quoted, or translated to another language without explicit permission from Elcomplus LLC.