

# SmartPTT Mobile User Guide for Android

# Revision History

---

<b>Revision</b>	<b>Description</b>	<b>Date</b>
1.2	Third release of the document. The document is compliant with SmartPTT Mobile 5.0.2.	July 2020
1.1	Second release of the document. The document is compliant with SmartPTT Mobile 5.0.1.	April 2020
1.0	First release of the document. The document is compliant with SmartPTT Mobile 5.0.0 beta.	March 2020

---

# Contents

<b>Revision History</b> .....	<b>2</b>
<b>About This Document</b> .....	<b>4</b>
<b>1. Overview</b> .....	<b>5</b>
1.1 Features .....	5
1.2 Requirements .....	6
<b>2. Installation and Configuration</b> .....	<b>7</b>
<b>3. Reconnection to Radioserver</b> .....	<b>8</b>
<b>4. Using SmartPTT Mobile</b> .....	<b>9</b>
4.1 Logging On to SmartPTT Mobile .....	9
4.2 Navigating Contact List .....	10
4.3 Voice Calls .....	11
4.3.1 Color Indication of Voice Calls .....	11
4.3.2 Performing Voice Calls .....	12
4.4 Editing SmartPTT Mobile Settings .....	12
4.5 Managing Virtual Groups .....	14
4.5.1 Creating Virtual Groups .....	14
4.5.2 Editing Virtual Groups .....	16
4.5.3 Deleting Virtual Groups .....	18
<b>Contact Information</b> .....	<b>20</b>

# About This Document

The document explains how to install, configure and use SmartPTT Mobile.

The document uses the following conventions:

- **Bold** represents the names and titles of graphical user interface elements. For example, the **Message** field.
- *Italic* represents the names of referenced manuals.

# 1 Overview

SmartPTT Mobile is an application that provides the ability to integrate mobile devices and MOTOTRBO radios into a single communication network via SmartPTT Radioserver. SmartPTT Mobile users can receive and initiate individual and group voice calls from/to radios and talkgroups, as well as other SmartPTT Mobile users.

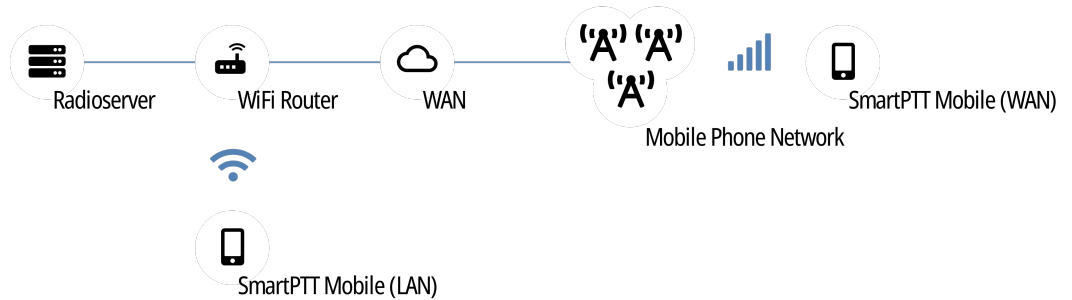

Fig. 1. SmartPTT Mobile Overview

SmartPTT Mobile requires a continuous connection to SmartPTT Radioserver to request and receive information. It operates only with the main SmartPTT Radioserver; alternate/redundant SmartPTT Radioserver is not supported.

## 1.1 Features

SmartPTT Mobile provides the following features:

- Voice communication with radios and talkgroups (group calls and private calls).
- Voice communication with other SmartPTT Mobile users (group calls and private calls).
- Ability to create virtual groups for simultaneous voice communication with SmartPTT Mobile users and talkgroups.
- Tracking users' online/offline status in real time.
- Ability to work in two modes: in high priority mode and in normal mode.

## 1.2 Requirements

For the best SmartPTT Mobile operation, the following requirements must be met:

Parameter	Value
Android Version:	6.0.0 or higher
Processor Frequency:	1.4 GHz
Memory (RAM and ROM):	RAM — 1 GB; free disk space — 15 MB
Support 4G networks (LTE):	Yes
Display size:	5"

### Networking Requirements

Parameter	Value
Bandwidth	> 65 kbps
Packet Loss	Good voice quality: 0.0–2.5% Poor voice quality: 2.5–15.0%
Two-Way Delay	< 90 ms
Jitter	< 90 ms

**NOTE**

These are minimal system requirements for SmartPTT Mobile. They can change depending on a device.

## 2 Installation and Configuration

SmartPTT Mobile is a mobile application distributed via Google Play. Once it has been installed, it needs to be given the permission to use a device microphone to operate correctly.

Before using SmartPTT Mobile you must configure client connections to support SmartPTT Mobile. For information on SmartPTT Radioserver configuration for use with SmartPTT Mobile, see "Configuring SmartPTT Mobile Connection" in *SmartPTT Installation and Configuration Guide*.

Besides, you must create a client account in SmartPTT Radioserver Configurator for logging on to the application. For details, see "Managing Client Accounts" in *SmartPTT Installation and Configuration Guide*.

SmartPTT Mobile can also interact with profiles, that are created in SmartPTT Radioserver Configurator and used to limit client access to radio networks and actions within available radio networks. Before using SmartPTT Mobile you must find out the necessity of assigning a profile to the client account. For details, see "Managing Profiles" in *SmartPTT Installation and Configuration Guide*.

## 3 Reconnection to Radioserver

Below is described the SmartPTT Mobile operation during a loss of connection with SmartPTT Radioserver and reconnection to it.

When reconnecting SmartPTT Mobile to SmartPTT Radioserver, the following scenarios of the mobile application behavior are possible:

- If the reason for the loss of connection with SmartPTT Radioserver is the Internet disconnection, the mobile application start screen will be displayed and the mobile application will wait for the restoration of the Internet connection. As soon as the Internet connection is restored, connection to SmartPTT Radioserver will be restored automatically.

### **Important**

Automatic connection to SmartPTT Radioserver will be established if successful client authorization was on SmartPTT Radioserver before.

- If the connection with SmartPTT Radioserver is lost because SmartPTT Radioserver for some reason closes the connection, the mobile application start screen will be displayed, connection to SmartPTT Radioserver will not be restored automatically.
- If for some reason the mobile application operation is stopped by the Android operating system, and the application is unloaded from the device's memory, then the next time you start it manually, the mobile application start screen will be displayed, connection to SmartPTT Radioserver will be restored automatically.
- If the device was rebooted, the mobile application start screen will be displayed, connection to SmartPTT Radioserver will not be restored automatically.
- After the client is log out, or SmartPTT Radioserver closed forcibly the connection, connection to SmartPTT Radioserver will not be restored automatically.



# 4 Using SmartPTT Mobile

This section describes SmartPTT Mobile functionality and provides instructions on using it.

## 4.1 Logging On to SmartPTT Mobile

Follow the procedure to log on to SmartPTT Mobile.

### Prerequisites:

- Determine SmartPTT Radioserver IP address and HTTP port number.
- Determine a client user name and password.

### Procedure:

1. Launch the SmartPTT Mobile application.  
The login screen appears.

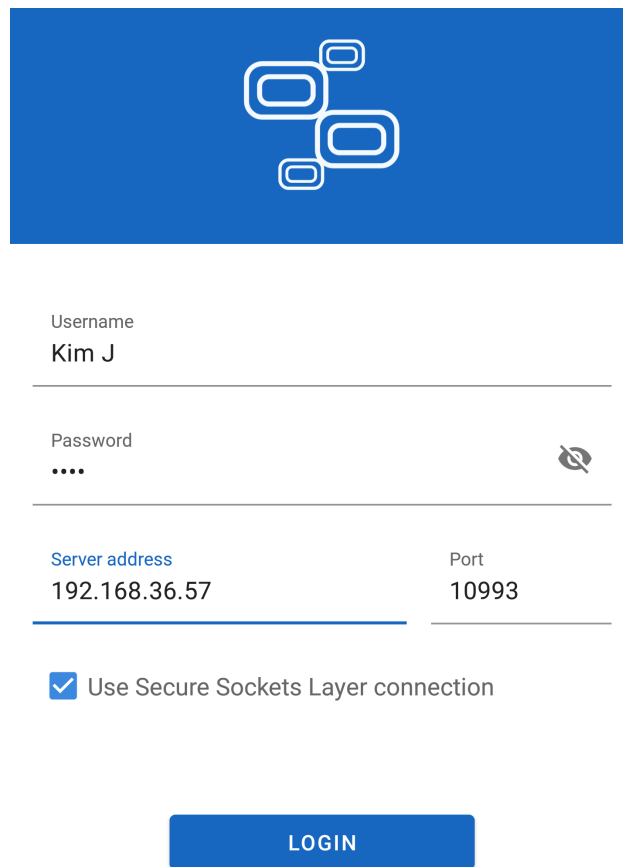

The login screen features a blue header with a white icon of four overlapping rounded rectangles. Below the header are four input fields: 'Username' with the text 'Kim J', 'Password' with four dots and a 'View Password' icon, 'Server address' with '192.168.36.57', and 'Port' with '10993'. A checkbox labeled 'Use Secure Sockets Layer connection' is checked. At the bottom is a blue 'LOGIN' button.

Fig. 2. SmartPTT Mobile Login Screen

2. In the **Username** field, type a client user name configured in SmartPTT Radioserver Configurator.
3. In the **Password** field, type the client password.
4. (Optional) Tap **View Password** (  ) to display password characters instead of bullets.
5. In the **Server address** field, type the SmartPTT Radioserver IP address.
6. In the **Port** field, type the SmartPTT Radioserver HTTP port number.

7. Clear the **Use Secure Sockets Layer connection** check box not to use the SSL connection.
8. Tap **Login**.

**Postrequisites:**

To quit the SmartPTT Mobile application, you must log out.

## 4.2 Navigating Contact List

Contact List is the main window of SmartPTT Mobile. It appears after a user logs in.

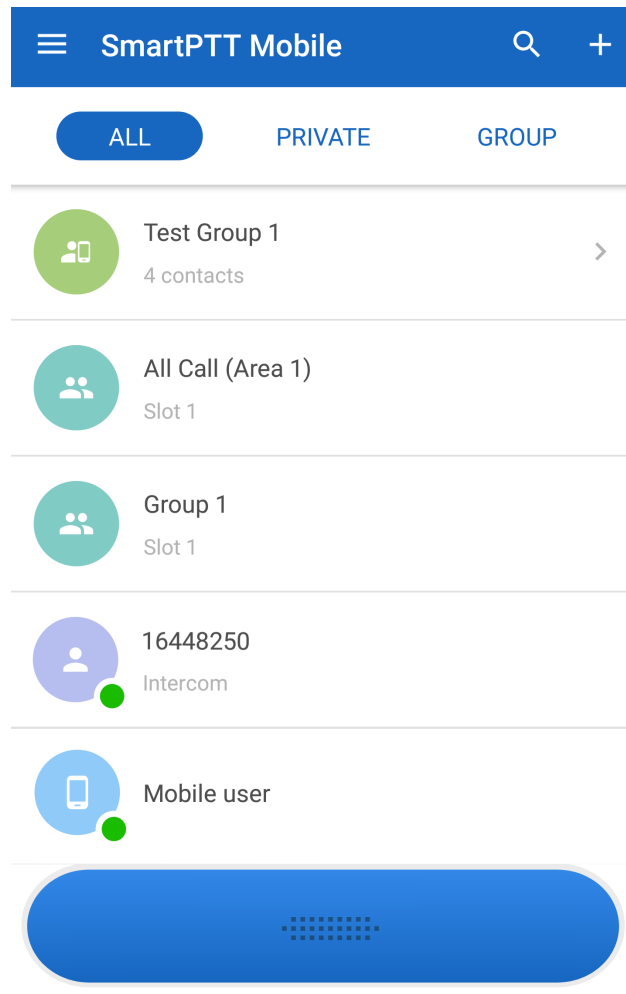

Fig. 3. Contact List

The Toolbar at the top of the window (appears if the window is scrolled up) provides the following elements:

**Menu (☰)**

Opens the SmartPTT Mobile side menu.

**Find contacts (🔍)**

Provides the ability to filter the Contact List by typing the beginning of a contact name in the search field that appears in the middle of the Toolbar.

**Group creation (+)**





Opens the **Group creation** window.

The filter pane below the Toolbar provides the following filters for the Contact List:

- **All** — the Contact List displays all contacts.
- **Private** — the Contact List displays only DMR radios and SmartPTT Mobile users.
- **Group** — the Contact List displays only DMR talkgroups and virtual groups.

The Contact List is the scrollable middle part of the window. Tapping a contact assigns it to the PTT button at the bottom of the window. Pressing the button will initiate a call to the selected contact.

The icon to the left of the contact name indicates the type of the contact:

- DMR talkgroup (  )
- DMR radio (  )
- SmartPTT Mobile user (  )
- Virtual group (  )

For DMR radios and SmartPTT Mobile users, online/offline status is displayed in the bottom right corner of the icon as a green or gray circle respectively.

For different types of contacts, the following is displayed as their name:

DMR talkgroup	Talkgroup name (as specified in SmartPTT Radioserver Configurator) with its channel below
DMR radio	Radio ID with its channel below
SmartPTT Mobile user	SmartPTT Mobile user login
Virtual group	Group name

The PTT button at the bottom of the window provides voice call indication and the ability to initiate calls.

## 4.3 Voice Calls

SmartPTT Mobile provides the ability to initiate and receive half-duplex voice calls to/from SmartPTT Mobile users, virtual groups (groups of SmartPTT Mobile users), DMR radios and DMR talkgroups.

### 4.3.1 Color Indication of Voice Calls

SmartPTT Mobile provides the following color indication of voice calls:

- No voice call in progress, no contact selected.



- No voice call in progress, a contact is selected. You can tap PTT to initiate a call.

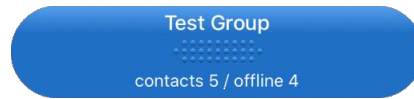

- Outgoing voice call in progress. Recipient name is displayed on the button.



- Incoming voice call in progress. Voice call initiator name is displayed on the button.

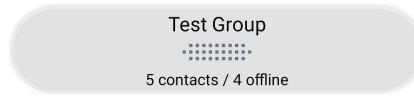

- Channel hold mode (hangtime) in progress. None of the parties are transmitting the voice call.



### 4.3.2 Performing Voice Calls

SmartPTT Mobile can initiate or receive only one voice call at a time. In order to receive a call, no action is necessary. Incoming voice is heard immediately and the voice call initiator's name is displayed on the PTT button.

In order to initiate a call, tap the desired contact in the Contact List, and then, depending on SmartPTT Mobile settings, either tap and hold, or tap the button. As soon as the outgoing call indication appears (the PTT button becomes orange), you can speak.

## 4.4 Editing SmartPTT Mobile Settings

Follow the procedure to edit SmartPTT Mobile settings.

### Prerequisites:

Log on to SmartPTT Mobile.

### Procedure:

1. In the Contact List, swipe from the left edge of the screen or tap the Menu (☰) button in the top left corner of the window.  
SmartPTT Mobile side menu appears.
2. In the menu, tap **Settings** → **Application**.  
The **Application** window appears.

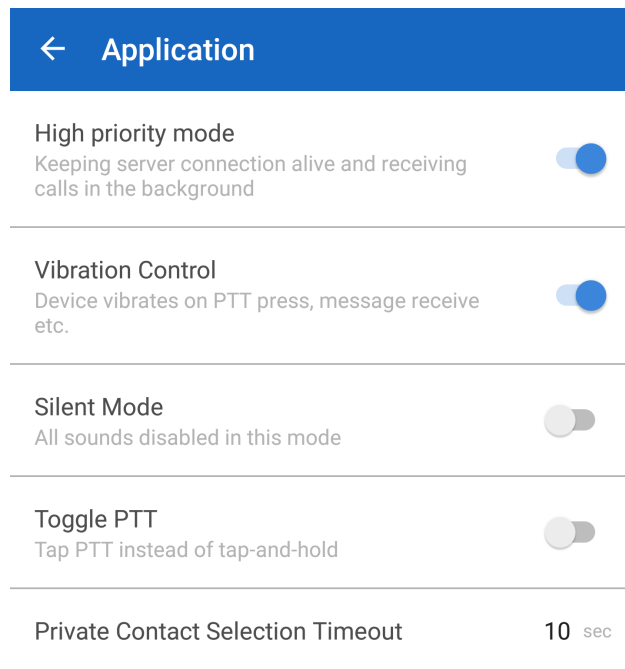

Fig. 4. Application Settings

- Configure the desired priority of the SmartPTT Mobile operation mode:

To configure SmartPTT Mobile to work in high priority mode,	turn on the <b>High priority mode</b> toggle.
---	---

To configure SmartPTT Mobile to work in normal mode,	turned off the <b>High priority mode</b> toggle.
--	--

### Important

Regardless of the selected operation mode, SmartPTT Mobile is always interrupted by incoming phone calls.

### NOTE

The priority of SmartPTT Mobile operation mode determines its behavior referring to SmartPTT Radioserver connection, as well as interacting with the microphone and speaker when minimizing application (switching to another application) or locking the screen when the application is active. In normal mode, connection with SmartPTT Radioserver is interrupted, the microphone and speaker are not used by the application. In high priority mode, connection with SmartPTT Radioserver is active, the application continues to use the speaker, but does not use a microphone.

- To have the device vibrate when a user initiates a call, turn on the **Vibration Control** toggle.
- To suppress tones when a call begins, ends or is interrupted, turn on the **Silent Mode** toggle.

6. Configure the PTT button behavior:

---

To initiate calls by tapping and holding PTT,	turn off the <b>Toggle PTT</b> toggle.
---	--

---

To initiate/end calls by single-tapping PTT,	turn on the <b>Toggle PTT</b> toggle.
--	---------------------------------------

---

7. In the **Private Contact Selection Timeout** line, tap the number to set the time in seconds during which a private contact selected from a virtual group contact list will remain assigned to the PTT button. After that, the PTT button will revert to the virtual group. Available values are 2, 4, 6, 8 and 10 seconds.

## 4.5 Managing Virtual Groups

Virtual groups are a type of group contact. They are created by SmartPTT Mobile users and can include SmartPTT Mobile users and DMR talkgroups (no more than one talkgroup per virtual group). When a virtual group is created, it appears on all SmartPTT Mobile users' contact lists added to the group.

### 4.5.1 Creating Virtual Groups

Follow the procedure to create a virtual group.

#### Prerequisites:

Log on to SmartPTT Mobile.

#### Procedure:

1. In the top right corner of the Contact List window, tap Group creation ( **+** ).  
The **Group creation** window appears.

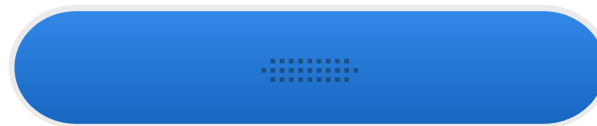
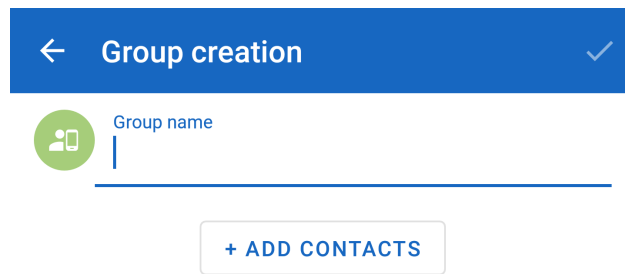

Fig. 5. Group Creation

2. In the **Group name** field, type the group name.
3. Add the desired contacts to the group:
  - a. Tap **Add Contacts**.  
The **Add Contacts** window appears.

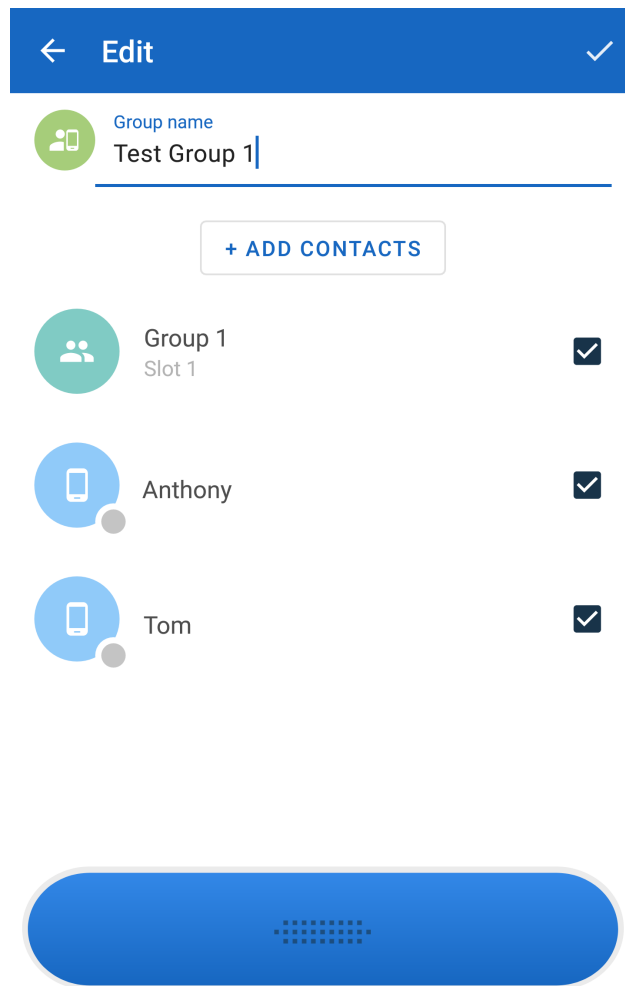

Fig. 6. Adding Contacts

- b. (Optional) In the **Search contacts** field, at the top of the window, type the beginning of a desired contact name to filter the list.
  - c. To add a contact to the group, select the check box to the right of its name.
  - d. At the top of the window, tap Confirm ( ✓ ) to accept changes or Discard ( ✕ ) to discard them.
4. In the top right corner of the **Group creation** window, tap Confirm ( ✓ ) to create the group.

## 4.5.2 Editing Virtual Groups

Follow the procedure to to edit a virtual group.

### Prerequisites:

Log on to SmartPTT Mobile.

### Procedure:

1. In the Contact List, to the right of the desired virtual group name, tap Profile ( > ).  
Virtual group profile appears.



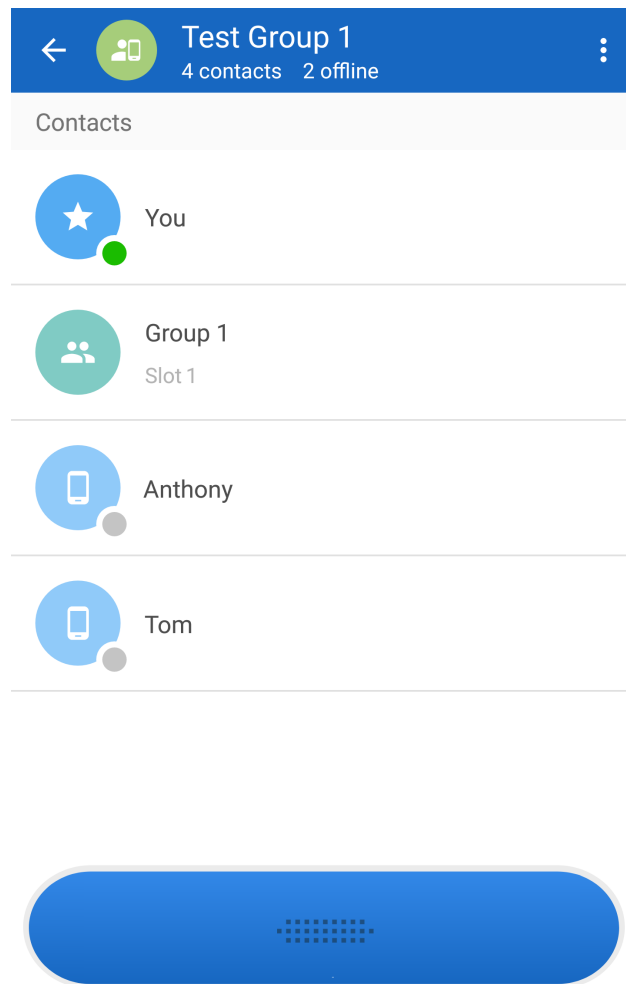



Fig. 7. Virtual Group Profile

2. In the top right corner of the window, tap More (  ), and then tap **Edit**. The **Edit** window appears.
3. Tap the group name to edit it.
4. Perform one of the following actions:

---



To remove a group member,

clear the check box to the right of their name.

---

To add a group member,

perform the following actions:

1. Tap **Add Contacts**.  
The **Add Contacts** window appears.
  2. *(Optional)* In the **Search contacts** field, at the top of the window, type the beginning of a desired contact name to filter the list.
  3. To add a contact to the group, select the check box to the right of its name.
  4. At the top of the window, tap Confirm (  ) to accept changes or Discard (  ) to discard them.
-

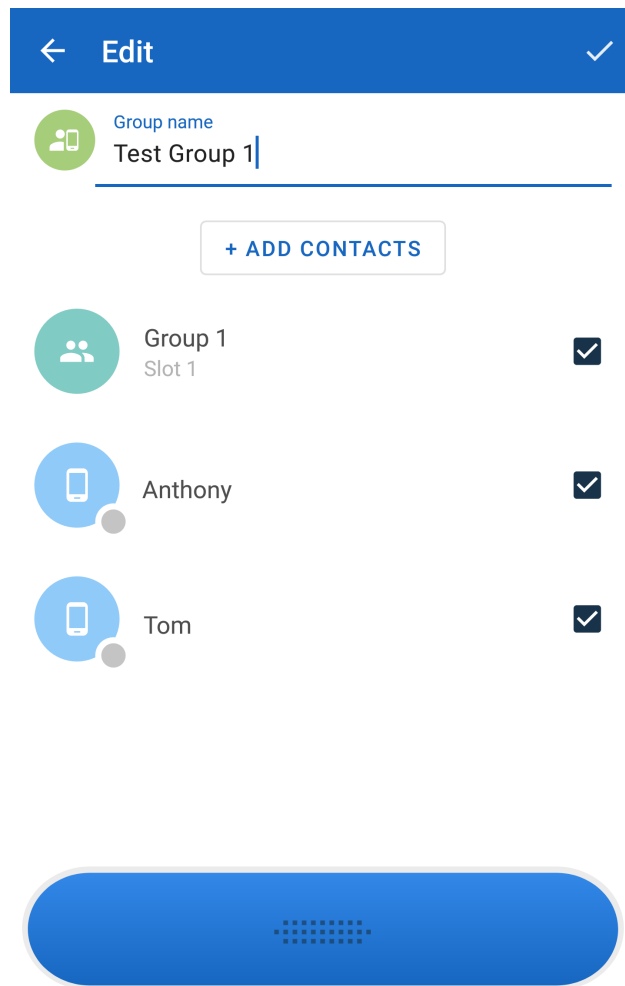

Fig. 8. Adding Contacts

5. In the top right corner of the **Edit** window, tap Confirm ( ✓ ) to save changes.

### 4.5.3 Deleting Virtual Groups

Follow the procedure to delete a virtual group.

**Prerequisites:**

Log on to SmartPTT Mobile.

**Procedure:**

1. In the Contact List, to the right of the desired virtual group name, tap Profile ( > ).  
Virtual group profile appears.

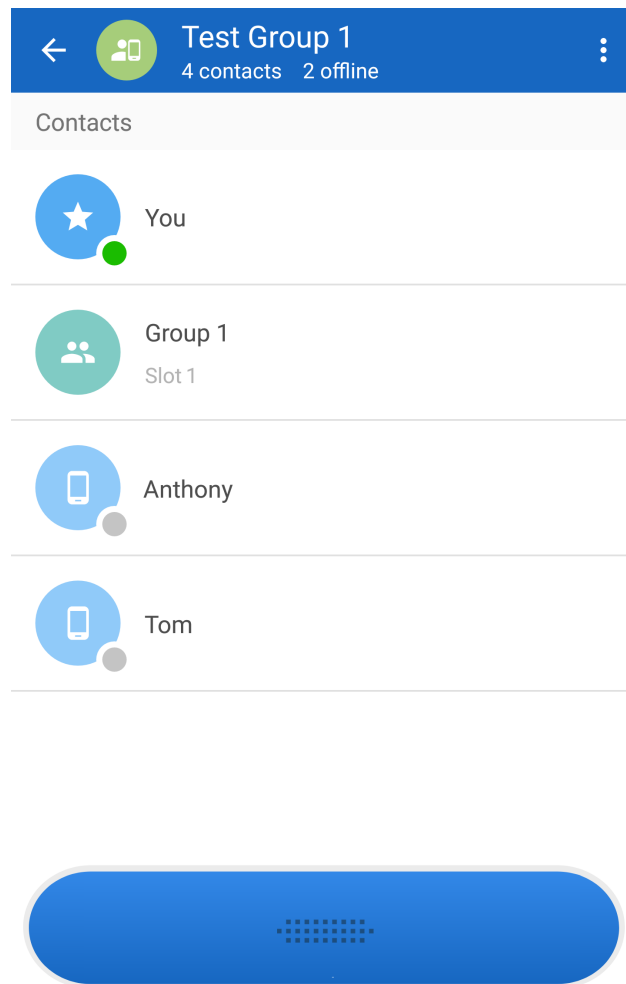



Fig. 9. Virtual Group Profile

1. In the top right corner of the window, tap More (  ), and then tap **Delete**.
2. In the dialog box that appears, confirm deletion.

# Contact Information

The document describes the product developed by Elcomplus LLC. The official company's website is [www.elcomplus.com](http://www.elcomplus.com).

For contact information with the Elcomplus LLC representatives, see [www.smartptt.com/contacts/](http://www.smartptt.com/contacts/).

## Technical Support

Customer support is provided by Technical Support Center. The official website of the Center is [support.smartptt.com](http://support.smartptt.com).

To contact the support engineer, perform one of the following actions:

- Fill in and submit the [support request](#) from the website.
- Email the support request to [support@smartptt.com](mailto:support@smartptt.com).

In America, customer support is also provided by Elcomplus, Inc. To contact support engineers, use the following contact information:

- Phone: +1 786-362-5525
- Email: [miami@smartptt.com](mailto:miami@smartptt.com)
- Mailbox: 290 NW 165th St, Ste P-200, 3rd Flr  
Miami, FL, 33169, USA

Technical Support Center and Elcomplus, Inc. do not consult on deployment and maintenance of Motorola Solutions products except on settings related to SmartPTT connection and data communication. For the technical support on Motorola Solutions products, please contact an authorized Motorola Solutions representative in your region.

## Customer Documentation

This document is authored and published by Elcomplus LLC. If you have any comments and suggestions on it, please email them to [support@smartptt.com](mailto:support@smartptt.com).

Not part of this document must be reproduced, quoted, or translated to another language without explicit permission from Elcomplus LLC.